



Government of Karnataka

SCIENCE

10

TENTH STANDARD

PART - 1

विद्यया ऽ मृतमश्नुते



एन सी ई आर टी
NCERT

राष्ट्रीय शैक्षिक अनुसंधान और प्रशिक्षण परिषद्
NATIONAL COUNCIL OF EDUCATIONAL RESEARCH AND TRAINING

Karnataka Textbook Society (R.)

100 Feet Ring Road, Banashankari 3rd Stage, Bengaluru - 85

10th Science English

First Edition

March 2018

Second Edition

March 2019

© **National Council of Educational Research and Training.**

Publication / Translation Rights

Karnataka Textbook Society, Bengaluru

Copyright Certificate No.

IN-KA-89413760 2221839

Date: 17 August - 2017

OFFICES OF THE PUBLICATION

KARNATAKA TEXTBOOK SOCIETY

#4, DSERT Building,

100 Feet Ring Road, Hosakerehalli,

Banashankari III Stage,

Benguluru - 560 085

Website: [http:// www.ktbs.kar.nic.in](http://www.ktbs.kar.nic.in)

ALL RIGHTS RESERVED

- No part of this publication may be reproduced, stored in a retrieval system or transmitted, in any form or by any means, electronic, mechanical, photocopying, recording or otherwise without the prior permission of the publisher.
- This book is sold subject to the condition that it shall not, by way of trade, be lent, re-sold, hired out or otherwise disposed of without the publisher's consent, in any form of binding or cover other than that in which it is published.
- The correct price of this publication is the price printed on this page. Any revised price indicated by a rubber stamp or by a sticker or by any other means is incorrect and should be unacceptable.

Acknowledgements

KARNATAKA TEXTBOOK SOCIETY wholeheartedly acknowledges the valuable contribution of officials of publication division, NCERT. Chairperson, Members of Textbook preparation Committee, Review Committee, Computer Officials and all officers of NCERT.

We are also thankful to NCERT Officials for providing copyright for publication / translation to regional mediums for Government of Karnataka, Department of Education.

FOREWORD

The National Curriculum Framework, (NCF), 2005, recommends that children's life at school must be linked to their life outside the school. This principle marks a departure from the legacy of bookish learning which continues to shape our system and causes a gap between the school, home and community. The syllabi and textbooks developed on the basis of NCF signify an attempt to implement this basic idea. They also attempt to discourage rote learning and the maintenance of sharp boundaries between different subject areas. We hope these measures will take us significantly further in the direction of a child-centred system of education outlined in the National Policy on Education (1986).

The success of this effort depends on the steps that school principals and teachers will take to encourage children to reflect on their own learning and to pursue imaginative activities and questions. We must recognise that, given space, time and freedom, children generate new knowledge by engaging with the information passed on to them by adults. Treating the prescribed textbook as the sole basis of examination is one of the key reasons why other resources and sites of learning are ignored. Inculcating creativity and initiative is possible if we perceive and treat children as participants in learning, not as receivers of a fixed body of knowledge.

These aims imply considerable change in school routines and mode of functioning. Flexibility in the daily time-table is as necessary as rigour in implementing the annual calendar so that the required number of teaching days are actually devoted to teaching. The methods used for teaching and evaluation will also determine how effective this textbook proves for making children's life at school a happy experience, rather than a source of stress or boredom. Syllabus designers have tried to address the problem of curricular burden by restructuring and reorienting knowledge at different stages with greater consideration for child psychology and the time available for teaching. The textbook attempts to enhance this endeavour by giving higher priority and space to opportunities for contemplation and wondering, discussion in small groups, and activities requiring hands-on experience.

The National Council of Educational Research and Training (NCERT) appreciates the hard work done by the textbook development team responsible for this book. We wish to thank the Chairman of the advisory group in science and mathematics, Professor J.V. Narlikar and the Chief Advisor for this book, Professor Rupamanjari Ghosh, School of Physical Sciences, Jawaharlal Nehru University, New Delhi, for guiding the work of this committee. Several teachers contributed to the development of this textbook; we are grateful to them and their principals for making this possible. We are indebted to the institutions and organisations which have generously permitted us to draw upon their resources, material and personnel. We are especially grateful to the members of the National Monitoring Committee, appointed by the Department of Secondary and Higher Education, Ministry of Human Resource Development under the Chairmanship of Professor Mrinal Miri and Professor G.P. Deshpande, for their valuable time and contribution. As an organisation committed to systemic reform and continuous improvement in the quality of its products, NCERT welcomes comments and suggestions which will enable us to undertake further revision and refinement.

New Delhi
20 November 2006

Director
National Council of Educational
Research and Training

PREFACE

This textbook of Science for Class X is a continuation of our attempt in the Class IX Science textbook to comply with the guidelines of the National Curriculum Framework-2005. We had to work within a limited time frame and also had our own constraints coming in the way of this radical change. The revised and re-structured syllabus for Class X covers selected topics in the broad themes of — Materials, The World of the Living, How Things Work, Natural Phenomena and Natural Resources. We have interpreted the syllabus to present a coherent coverage of scientific concepts related to our daily life on the select topics. It is an integrated approach to science at this level, with no sharp divisions into disciplines such as Physics, Chemistry, Biology and Environmental Science.

There has been a conscious attempt to address the relevant social concerns in this science textbook wherever possible — the concerns for people with special needs, the issues of gender discrimination, energy and environment have found their natural place in this book. Students have been encouraged to get into the debates on some of the management concerns (for sustainable development, for example) so that they can arrive at their own decisions after a scientific analysis of all the facts.

This book has some features which are meant to enhance its effectiveness. The theme of each chapter has been introduced with examples from daily life, and if possible, by a relevant activity that the students have to perform. The entire approach of the book is, in fact, activity-based, i.e., the students are required to construct knowledge themselves from these activities. The emphasis is not on definitions and technical terms, but on the concepts involved. Special care has been taken so that the rigour of science is not lost while simplifying the language. Difficult and challenging ideas, which are not to be covered at this stage, have often been placed as extra material in the boxes in light orange. The excitement of doing science comes from pursuing the unknown — the students would have the opportunity to think and explore somewhat beyond the syllabus and may feel the urge to continue their scientific expedition at higher levels. All such box items, including brief biography of scientists, are, of course, non-evaluative.

Solved examples are provided, wherever felt necessary, to clarify a concept. The in-text questions after a main section are for the students to check their understanding of the topic. At the end of each chapter, there is a quick review of the important points covered in the chapter. We have introduced some multiple choice questions in the exercises. There are problems of different difficulty levels answers to the multiple-choice questions and numericals, and hints for the difficult questions are included at the end of the book.

This book has been made possible because of the active participation of many people. I wish to thank Professor Krishna Kumar, Director, NCERT, Prof. G. Ravindra, Joint Director, NCERT, and

Professor Hukum Singh, Head, Department of Education in Science and Mathematics, NCERT, specially for their keen interest in the development of the book and for all the administrative support. I wish to put on record my sincere appreciation for Dr Anjni Koul, the member-coordinator of the textbook development committee, for her extraordinary commitment and efficiency. It has been a real pleasure working with my textbook development team and the review committee. The chosen editorial team worked extremely hard, on tight deadlines, to bring the book close to the shape that we dreamt of. Fruitful discussions with some members of the MHRD Monitoring Committee helped in providing the final touches to the book. I do not have the words to acknowledge the professional and personal inputs I received from some of my close friends during the preparation of this book. We warmly welcome comments and suggestions for improvement from our readers.

Rupamanjari Ghosh

Professor of Physics
School of Physical Sciences
Jawaharlal Nehru University
New Delhi

TEXTBOOK DEVELOPMENT COMMITTEE

CHAIRMAN, ADVISORY GROUP FOR TEXTBOOKS IN SCIENCE AND MATHEMATICS

J.V. Narlikar, *Emeritus Professor*, Inter-University Centre for Astronomy and Astrophysics (IUCAA), Ganeshkhind, Pune University, Pune

CHIEF ADVISOR

Rupamanjari Ghosh, *Professor*, School of Physical Sciences, Jawaharlal Nehru University, New Delhi

MEMBERS

Alka Mehrotra, *Reader*, DESM, NCERT, New Delhi

Animesh K. Mohapatra, *Reader*, Regional Institute of Education, Ajmer

B.B. Swain, *Professor (Retd.)*, Department of Physics, Utkal University, Orissa

B.K. Sharma, *Professor*, DESM, NCERT, New Delhi

B.K. Tripathi, *Reader*, DESM, NCERT, New Delhi

Brahm Parkash, *Professor*, DESM, NCERT, New Delhi

Charu Maini, *PGT*, Salwan Public School, Gurgaon, Haryana

Dinesh Kumar, *Reader*, DESM, NCERT, New Delhi

Gagan Gupta, *Reader*, DESM, NCERT, New Delhi

H.L. Satheesh, *TGT*, DM School, Regional Institute of Education, Mysore

Ishwant Kaur, *PGT*, DM School, Regional Institute of Education, Bhopal

J.D. Arora, *Reader*, Hindu College, Moradabad, Uttar Pradesh

Meenambika Menon, *TGT*, Cambridge School, Noida, Uttar Pradesh

Puran Chand, *Professor* and *Jt. Director (Retd.)*, Central Institute of Educational Technology NCERT, New Delhi

Reeta Sharma, *Reader*, Regional Institute of Education, Bhopal

R.P. Singh, *Lecturer*, Rajkiya Pratibha Vikas Vidyalaya, Kishan Ganj, Delhi

Satyajit Rath, *Scientist*, National Institute of Immunology, JNU Campus, New Delhi

S.K. Dash, *Reader*, Regional Institute of Education, Bhubaneswar

Sunita Ramrakhiani, *PGT*, Ahlcon Public School, Delhi

Uma Sudhir, *Eklavya*, Indore, Madhya Pradesh

Vandana Saxena, *TGT*, Kendriya Vidyalaya-4, Kandhar Lines, Delhi Cantt., New Delhi

Vinod Kumar, *Reader*, Hans Raj College, Delhi University, Delhi

MEMBER-COORDINATOR

Anjni Koul, *Lecturer*, DESM, NCERT, New Delhi

ACKNOWLEDGEMENTS

The National Council of Educational Research and Training (NCERT), besides expressing its gratefulness towards the members of the Textbook Development Committee for their contribution in the development of the Science Textbook for Class X, also acknowledges the contribution of the following members for reviewing, editing, refining, and finalisation of the manuscript of the book. Kanhiya Lal, *Principal* (Retd.), Directorate of Education, NCT, Delhi; Ranveer Singh, *Lecturer*, Sarvodaya Bal Vidyalaya, Timarpur, Delhi; Bharat Poorey, *Professor* (Retd.), Govt. Post Graduate College, Indore; Gagandeep Bajaj, *Lecturer*, S.P.M. College, Delhi University, Delhi; Ravinder Kaur, *TGT*, Kendriya Vidyalaya, Rohini, Delhi; Renu Puri, *TGT*, N.C. Jindal Public School, New Delhi; Sarita Kumar, *Reader*, Acharya Narendra Dev College, Delhi University, Delhi; Shashi Prabha, *Lecturer*, DESM, NCERT, Delhi; Rashmi Sharma, *Lecturer*, NERIE, Shillong; Sushma Jaireth, *Reader*, DWS, NCERT, New Delhi; Y.P. Purang, Addl. Director of Education (Retd.), NCT, Delhi; Neeta Agarwal, *TGT*, D.L.D.A.V. Model School, Pitampura, Delhi; Roma Anand, *TGT*, D.L.D.A.V., Pitampura, Delhi; Veer Pal Singh, *Reader*, DEME, NCERT, New Delhi and S.L. Varte, *Lecturer*, DESM, NCERT, New Delhi.

The Council also acknowledges the valuable contribution of Sunita Farkya (*Professor*, DESM), Pushplata Verma (*Assistant Professor*, DESM), K.C. Tripathi (*Professor*, DEL) and Jatindra Mohan Misra (*Professor*, DEL) in updating Chapter 16 titled "Sustainable Management of Natural Resources", and also in the review of this textbook.

The contribution of R.S. Sindhu, *Professor* (Retd.), DESM; V.P. Srivastava, *Professor* (Retd.), DESM; R.K. Parashar, Rachna Garg (*Professors*, DESM); V.V. Anand, *Professor* (Retd.), RIE Mysore; S.V. Sharma (*Professor*, RIE Mysore); V.P. Singh (*Professor*, RIE Ajmer); R. Joshi, *Associate Professor* (Retd.), DESM; C.V. Shimray, Ruchi Verma (*Associate Professors*, DESM); Ram Babu Pareek (*Associate Professor*, RIE Ajmer); A.K. Srivastava, Rejaul Karim Barbhuiya, Pramila Tanwar (*Assistant Professors*, DESM); R.R. Koireng (*Assistant Professor*, DCS); V. Tangpu (*Assistant Professor*, RIE Mysore) and Akhileshwar Mishra (*Head Master*, DMS, RIE Bhubaneswar), in the review of this textbook in 2017-18 are acknowledged.

Special thanks are due to Hukum Singh, *Professor* and Former *Head*, DESM, NCERT, New Delhi, for providing all academic and administrative support.

The Council also gratefully acknowledges the support provided by the APC Office of DESM, administrative staff of DESM; Deepak Kapoor, *Incharge*, Computer Station, DESM; Saima and Arvind Sharma, *DTP Operators* and Rajesh Handa, *Illustrator*; Mohd. Qamar Tabrez and Musarrat Parveen, *Copy Editors*; Seema Yadav, *Proof Reader*. The efforts of the Publication Department, NCERT are also highly appreciated.

ಮುನ್ನುಡಿ

2005ನೇ ರಾಷ್ಟ್ರೀಯ ಪಠ್ಯಕ್ರಮದ ಆಧಾರದ ಮೇಲೆ ರಚಿತವಾದ ರಾಷ್ಟ್ರೀಯ ಪಠ್ಯವಸ್ತುವಿನ ಆಧಾರದ ಮೇಲೆ ರಚಿತವಾದ ಎನ್.ಸಿ.ಇ.ಆರ್.ಟಿ 10ನೆಯ ತರಗತಿಯ ವಿಜ್ಞಾನ ಪಠ್ಯಪುಸ್ತಕವನ್ನು ಯಥಾವತ್ತಾಗಿ ಕನ್ನಡ ಭಾಷೆಗೆ ಅನುವಾದ ಮಾಡಿ ಪ್ರಸ್ತುತ ಸಾಲಿನಲ್ಲಿ ಜಾರಿಗೊಳಿಸಲಾಗುತ್ತಿದೆ. ಈ ಪಠ್ಯಪುಸ್ತಕವನ್ನು ಒಟ್ಟು 7 ಮಾಧ್ಯಮಗಳಲ್ಲಿ ಹೊರತರಲಾಗಿದೆ. NCF-2005ರ ಪಠ್ಯಕ್ರಮದ ಎಲ್ಲ ವೈಶಿಷ್ಟ್ಯಗಳನ್ನು ಹೊಂದಿದೆ.

2005ರ ರಾಷ್ಟ್ರೀಯ ಪಠ್ಯಕ್ರಮವು ಈ ಕೆಳಗಿನ ವೈಶಿಷ್ಟ್ಯಗಳನ್ನು ಹೊಂದಿದೆ.

- ಕಲಿಕೆಯನ್ನು ಜೀವನದ ಅವಶ್ಯಕತೆಗಳೊಂದಿಗೆ ಜೋಡಿಸುವುದು.
- ಕಂಠಪಾಠ ವಿಧಾನದಿಂದ ಕಲಿಕೆಯನ್ನು ಮುಕ್ತಗೊಳಿಸುವುದು.
- ಪಠ್ಯಪುಸ್ತಕಗಳ ಹೊರತಾಗಿ ಪಠ್ಯಕ್ರಮವನ್ನು ಶ್ರೀಮಂತಗೊಳಿಸುವುದು.
- ಜ್ಞಾನದ ಅಭಿವೃದ್ಧಿಗೆ ಕಲಿಕಾ ಅನುಭವಗಳನ್ನು ಬಳಸುವುದು.
- ಭಾರತದ ಪ್ರಜಾಸತ್ತಾತ್ಮಕ ನೀತಿಯನ್ವಯ ಮಕ್ಕಳ ಅವಶ್ಯಕತೆಗಳಿಗೆ ತಕ್ಕಂತೆ ಸ್ಪಂದಿಸುವುದು.
- ಶಿಕ್ಷಣವನ್ನು ಇಂದಿನ ಹಾಗೂ ಭವಿಷ್ಯದ ಜೀವನಾವಶ್ಯಕತೆಗಳಿಗೆ ಹೊಂದುವಂತೆ ಮಾಡುವುದು.
- ವಿಷಯಗಳ ಮೇಲೆಗಳನ್ನು ಮೀರಿ ಅವುಗಳಿಗೆ ಸಮಗ್ರ ದೃಷ್ಟಿಯ ಬೋಧನೆಯನ್ನು ಅಳವಡಿಸುವುದು.
- ಶಾಲೆಯ ಹೊರಗಿನ ಬದುಕಿಗೆ ಜ್ಞಾನ ಸಂಯೋಜನೆ.
- ಮಕ್ಕಳಿಂದಲೇ ಜ್ಞಾನವನ್ನು ಅಭಿವೃದ್ಧಿಪಡಿಸುವುದು.

10ನೇ ತರಗತಿಯ ವಿಜ್ಞಾನ ಪುಸ್ತಕದಲ್ಲಿ ಅಂತರ್ಗತ ವಿಧಾನ (Integrated Approach), ರಚನಾತ್ಮಕ ವಿಧಾನ (Constructive Approach) ಹಾಗೂ ಸುರುಳಿಯಾಕಾರದ ವಿಧಾನ (Spiral Approach) ಗಳನ್ನು ಅಳವಡಿಸಲಾಗಿದೆ.

ಪಠ್ಯಪುಸ್ತಕಗಳ ವಿಷಯ ಹಾಗೂ ಅಭ್ಯಾಸಗಳು ವಿದ್ಯಾರ್ಥಿಗಳನ್ನು ಯೋಚನೆ ಮಾಡುವಂತೆ ಮಾಡಿ, ಚಟುವಟಿಕೆಗಳ ಮೂಲಕ ಜ್ಞಾನ ಹಾಗೂ ಸಾಮರ್ಥ್ಯಗಳನ್ನು ಪಡೆಯುವಂತೆ ಮಾಡುವ ಪ್ರಯತ್ನ ಮಾಡಲಾಗಿದೆ. ಪಠ್ಯವಸ್ತುಗಳೊಂದಿಗೆ ಅತ್ಯಂತ ಅವಶ್ಯಕ ಜೀವನ ಮೌಲ್ಯಗಳನ್ನು ಅಂತರ್ಗತವಾಗಿ ಬಳಸಲಾಗಿದೆ. ಈ ನೂತನ ಪಠ್ಯಪುಸ್ತಕಗಳು ಪರೀಕ್ಷಾ ದೃಷ್ಟಿಯಿಂದ ರಚಿತವಾಗಿಲ್ಲ. ಬದಲಾಗಿ ಅವುಗಳು ವಿದ್ಯಾರ್ಥಿಗಳ ಸರ್ವಾಂಗೀಣ ವ್ಯಕ್ತಿತ್ವ ವಿಕಸನಕ್ಕೆ ಪೂರಕವಾಗಿವೆ. ತನ್ಮೂಲಕ ಅವರನ್ನು ಸ್ವತಂತ್ರ ಭಾರತದ ಸ್ಪಷ್ಟಸಮಾಜದ ಉತ್ತಮ ಪ್ರಜೆಗಳನ್ನಾಗಿ ಮಾಡುವ ಪ್ರಯತ್ನ ನಡೆದಿದೆ.

ನಿತ್ಯ ಜೀವನದಲ್ಲಿ ವಿಜ್ಞಾನವು ಎಲ್ಲಾ ಹಂತಗಳಲ್ಲೂ ಯಶಸ್ಸಿಗೆ ಅತ್ಯವಶ್ಯಕವಾಗಿದೆ. ರಾಷ್ಟ್ರೀಯ ಪಠ್ಯಕ್ರಮ-2005ರಂತೆ ವಿಜ್ಞಾನದ ಪರಿಕಲ್ಪನೆಗಳನ್ನು ಅರ್ಥಮಾಡಿಕೊಂಡು ಪರೀಕ್ಷೆಯಲ್ಲಿ ಉತ್ತಮ ಅಂಕಗಳನ್ನು ಪಡೆಯುವುದರ ಜೊತೆಗೆ ವಿಜ್ಞಾನವನ್ನು ಜೀವನದ ಸಕಲ ಕ್ಷೇತ್ರಗಳಲ್ಲೂ ಬಳಸುವ ಸಾಮರ್ಥ್ಯವನ್ನು ಬೆಳೆಸಿಕೊಂಡು ಜೀವನದಲ್ಲಿ ಯಶಸ್ಸನ್ನು ಗಳಿಸುವಂತೆ ಮಾಡಬೇಕು. ಅದು ಸಹಕಾರಿ ಕಲಿಕೆಗೂ ಪೂರಕವಾಗಿರಬೇಕು.

ಈ ಪಠ್ಯಪುಸ್ತಕವು ವಿದ್ಯಾರ್ಥಿ ಸ್ನೇಹಿ ಹಾಗೂ ಶಿಕ್ಷಕ ಸ್ನೇಹಿಯಾಗಿದೆ. ವಿಜ್ಞಾನ ಕಲಿಕೆ ಸಂತೋಷದಾಯಕ ಹಾಗೂ ಅರ್ಥಪೂರ್ಣವಾಗುವಂತೆ ಮಾಡಲು ಈ ಪಠ್ಯಪುಸ್ತಕವು ಸೂಕ್ತವಾದ ದಾರಿಯನ್ನು ರೂಪಿಸುತ್ತದೆಯೆಂದು ನಾವು ಭಾವಿಸುತ್ತೇವೆ.

ಈ ಪಠ್ಯಪುಸ್ತಕವನ್ನು ಹೆಚ್ಚು ಉತ್ತಮಪಡಿಸಲು ತಜ್ಞರಿಂದ, ಶಿಕ್ಷಕರಿಂದ, ವಿದ್ಯಾರ್ಥಿಗಳಿಂದ ಮತ್ತು ಪೋಷಕರಿಂದ ರಚನಾ ಸಲಹೆಗಳನ್ನು ಮತ್ತು ಟೀಕೆಗಳನ್ನು ಸ್ವಾಗತಿಸುತ್ತೇವೆ.

ರಾಜ್ಯದಲ್ಲಿ, ಈ ಪುಸ್ತಕವನ್ನು ಕನ್ನಡ ಮರಾಠಿ, ತೆಲುಗು ಮತ್ತು ತಮಿಳು ಮಾಧ್ಯಮಗಳಿಗೆ ಭಾಷಾಂತರಿಸಿದ ಎಲ್ಲ ಸಂಪನ್ಮೂಲ ವ್ಯಕ್ತಿಗಳಿಗೆ, ಕಾರ್ಯಕ್ರಮ ಸಂಯೋಜನೆ ಮಾಡಿದ ಕಾರ್ಯಕ್ರಮಾಧಿಕಾರಿಗೆ, ಸುಂದರವಾಗಿ ಡಿಟಿಪಿ ಕಾರ್ಯವನ್ನು ನಿರ್ವಹಿಸಿರುವ ಡಿಟಿಪಿ ಆಪರೇಟರ್‌ಗಳು ಹಾಗೂ ಸಂಸ್ಥೆಗೆ, ಪುಸ್ತಕವನ್ನು ಅಚ್ಚುಕಟ್ಟಾಗಿ ಮುದ್ರಿಸಿ ವಿತರಿಸಿರುವ ಮುದ್ರಕರುಗಳಿಗೆ ಈ ಸಂದರ್ಭದಲ್ಲಿ ಕರ್ನಾಟಕ ಪಠ್ಯಪುಸ್ತಕ ಸಂಘವು ಹೃತ್ಪೂರ್ವಕ ಕೃತಜ್ಞತೆಗಳನ್ನು ಅರ್ಪಿಸುತ್ತದೆ.

ಹೆಚ್.ಎನ್. ಗೋಪಾಲಕೃಷ್ಣ

ವ್ಯವಸ್ಥಾಪಕ ನಿರ್ದೇಶಕರು

ಕರ್ನಾಟಕ ಪಠ್ಯಪುಸ್ತಕ ಸಂಘ(ರಿ)

ಬೆಂಗಳೂರು

CONTENTS



PART - 1

S. No.	NCERT Chapter Number.	Chapter Name	Page No.
I	Chapter 1	Chemical Reactions and Equations	1 - 16
II	Chapter 2	Acids, Bases and Salts	17 - 36
III	Chapter 3	Metals and Non-metals	37 - 58
IV	Chapter 6	Life Processes	59 - 79
V	Chapter 7	Control and Coordination	80 - 92
VI	Chapter 12	Electricity	93 - 116
VII	Chapter 13	Magnetic Effects of Electric Current	117 - 135
VIII	Chapter 15	Our Environment	136 - 145
		Answers	146
Total	8 Chapters		

"Facts are not science — as the dictionary is not literature."
Martin H. Fischer

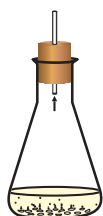

CHAPTER 1

Chemical Reactions and Equations

Consider the following situations of daily life and think what happens when –

- milk is left at room temperature during summers.
- an iron tawa/pan/nail is left exposed to humid atmosphere.
- grapes get fermented.
- food is cooked.
- food gets digested in our body.
- we respire.

In all the above situations, the nature and the identity of the initial substance have somewhat changed. We have already learnt about physical and chemical changes of matter in our previous classes. Whenever a chemical change occurs, we can say that a chemical reaction has taken place.

You may perhaps be wondering as to what is actually meant by a chemical reaction. How do we come to know that a chemical reaction has taken place? Let us perform some activities to find the answer to these questions.

Activity 1.1

CAUTION: This Activity needs the teacher's assistance. It would be better if students wear suitable eyeglasses.

- Clean a magnesium ribbon about 3-4 cm long by rubbing it with sandpaper.
- Hold it with a pair of tongs. Burn it using a spirit lamp or burner and collect the ash so formed in a watch-glass as shown in Fig. 1.1. Burn the magnesium ribbon keeping it away as far as possible from your eyes.
- What do you observe?

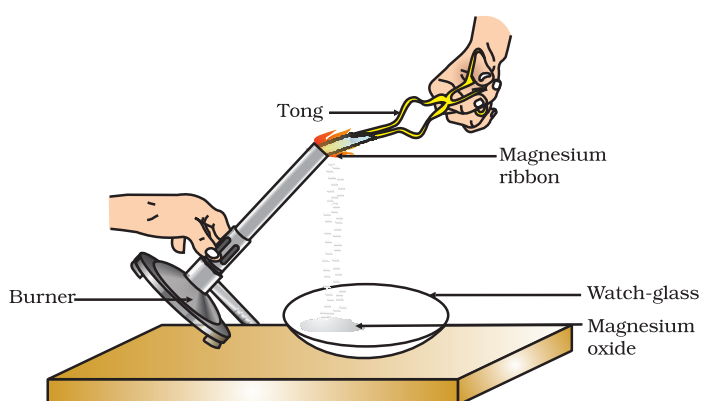

Figure 1.1

Burning of a magnesium ribbon in air and collection of magnesium oxide in a watch-glass

You must have observed that magnesium ribbon burns with a dazzling white flame and changes into a white powder. This powder is magnesium oxide. It is formed due to the reaction between magnesium and oxygen present in the air.

Activity 1.2

- Take lead nitrate solution in a test tube.
- Add potassium iodide solution to this.
- What do you observe?

Activity 1.3

- Take a few zinc granules in a conical flask or a test tube.
- Add dilute hydrochloric acid or sulphuric acid to this (Fig. 1.2).
- **CAUTION:** Handle the acid with care.
- Do you observe anything happening around the zinc granules?
- Touch the conical flask or test tube. Is there any change in its temperature?

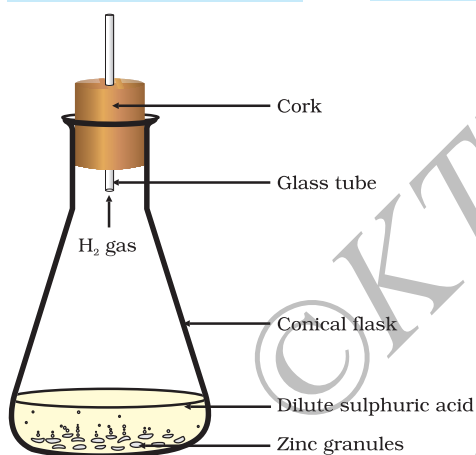

Figure 1.2
Formation of hydrogen gas by the action of dilute sulphuric acid on zinc

From the above three activities, we can say that any of the following observations helps us to determine whether a chemical reaction has taken place –

- change in state
- change in colour
- evolution of a gas
- change in temperature.

As we observe the changes around us, we can see that there is a large variety of chemical reactions taking place around us. We will study about the various types of chemical reactions and their symbolic representation in this Chapter.

1.1 CHEMICAL EQUATIONS

Activity 1.1 can be described as – when a magnesium ribbon is burnt in oxygen, it gets converted to magnesium oxide. This description of a chemical reaction in a sentence form is quite long. It can be written in a shorter form. The simplest way to do this is to write it in the form of a word-equation.

The word-equation for the above reaction would be –



The substances that undergo chemical change in the reaction (1.1), magnesium and oxygen, are the reactants. The new substance is magnesium oxide, formed during the reaction, as a product.

A word-equation shows change of reactants to products through an arrow placed between them. The reactants are written on the left-hand side (LHS) with a plus sign (+) between them. Similarly, products are written on the right-hand side (RHS) with a plus sign (+) between them. The arrowhead points towards the products, and shows the direction of the reaction.

1.1.1 Writing a Chemical Equation

Is there any other shorter way for representing chemical equations? Chemical equations can be made more concise and useful if we use chemical formulae instead of words. A chemical equation represents a chemical reaction. If you recall formulae of magnesium, oxygen and magnesium oxide, the above word-equation can be written as –



Count and compare the number of atoms of each element on the LHS and RHS of the arrow. Is the number of atoms of each element the same on both the sides? If yes, then the equation is balanced. If not, then the equation is unbalanced because the mass is not the same on both sides of the equation. Such a chemical equation is a skeletal chemical equation for a reaction. Equation (1.2) is a skeletal chemical equation for the burning of magnesium in air.

1.1.2 Balanced Chemical Equations

Recall the law of conservation of mass that you studied in Class IX; mass can neither be created nor destroyed in a chemical reaction. That is, the total mass of the elements present in the products of a chemical reaction has to be equal to the total mass of the elements present in the reactants.

In other words, the number of atoms of each element remains the same, before and after a chemical reaction. Hence, we need to balance a skeletal chemical equation. Is the chemical Eq. (1.2) balanced? Let us learn about balancing a chemical equation step by step.

The word-equation for Activity 1.3 may be represented as –



The above word-equation may be represented by the following chemical equation –



Let us examine the number of atoms of different elements on both sides of the arrow.

Element	Number of atoms in reactants (LHS)	Number of atoms in products (RHS)
Zn	1	1
H	2	2
S	1	1
O	4	4

As the number of atoms of each element is the same on both sides of the arrow, Eq. (1.3) is a balanced chemical equation.

Let us try to balance the following chemical equation –



Step I: To balance a chemical equation, first draw boxes around each formula. Do not change anything inside the boxes while balancing the equation.



Step II: List the number of atoms of different elements present in the unbalanced equation (1.5).

Element	Number of atoms in reactants (LHS)	Number of atoms in products (RHS)
Fe	1	3
H	2	2
O	1	4

Step III: It is often convenient to start balancing with the compound that contains the maximum number of atoms. It may be a reactant or a product. In that compound, select the element which has the maximum number of atoms. Using these criteria, we select Fe_3O_4 and the element oxygen in it. There are four oxygen atoms on the RHS and only one on the LHS.

To balance the oxygen atoms –

Atoms of oxygen	In reactants	In products
(i) Initial	1 (in H_2O)	4 (in Fe_3O_4)
(ii) To balance	1 4	4

To equalise the number of atoms, it must be remembered that we cannot alter the formulae of the compounds or elements involved in the reactions. For example, to balance oxygen atoms we can put coefficient '4' as $4\text{H}_2\text{O}$ and not H_2O_4 or $(\text{H}_2\text{O})_4$. Now the partly balanced equation becomes –



Step IV: Fe and H atoms are still not balanced. Pick any of these elements to proceed further. Let us balance hydrogen atoms in the partly balanced equation.

To equalise the number of H atoms, make the number of molecules of hydrogen as four on the RHS.

Atoms of hydrogen	In reactants	In products
(i) Initial	8 (in $4\text{H}_2\text{O}$)	2 (in H_2)
(ii) To balance	8	2 4

The equation would be –



Step V: Examine the above equation and pick up the third element which is not balanced. You find that only one element is left to be balanced, that is, iron.

Atoms of iron	In reactants	In products
(i) Initial	1 (in Fe)	3 (in Fe ₃ O ₄)
(ii) To balance	1 3	3

To equalise Fe, we take three atoms of Fe on the LHS.



Step VI: Finally, to check the correctness of the balanced equation, we count atoms of each element on both sides of the equation.



The numbers of atoms of elements on both sides of Eq. (1.9) are equal. This equation is now balanced. This method of balancing chemical equations is called hit-and-trial method as we make trials to balance the equation by using the smallest whole number coefficient.

Step VII: Writing Symbols of Physical States Carefully examine the above balanced Eq. (1.9). Does this equation tell us anything about the physical state of each reactant and product? No information has been given in this equation about their physical states.

To make a chemical equation more informative, the physical states of the reactants and products are mentioned along with their chemical formulae. The gaseous, liquid, aqueous and solid states of reactants and products are represented by the notations (g), (l), (aq) and (s), respectively. The word aqueous (aq) is written if the reactant or product is present as a solution in water.

The balanced Eq. (1.9) becomes



Note that the symbol (g) is used with H₂O to indicate that in this reaction water is used in the form of steam.

Usually physical states are not included in a chemical equation unless it is necessary to specify them.

Sometimes the reaction conditions, such as temperature, pressure, catalyst, etc., for the reaction are indicated above and/or below the arrow in the equation. For example –

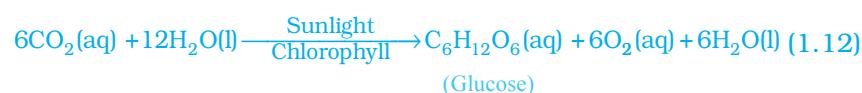

Using these steps, can you balance Eq. (1.2) given in the text earlier?

Q U E S T I O N S

1. Why should a magnesium ribbon be cleaned before burning in air?
2. Write the balanced equation for the following chemical reactions.
 - (i) Hydrogen + Chlorine \rightarrow Hydrogen chloride
 - (ii) Barium chloride + Aluminium sulphate \rightarrow Barium sulphate + Aluminium chloride
 - (iii) Sodium + Water \rightarrow Sodium hydroxide + Hydrogen
3. Write a balanced chemical equation with state symbols for the following reactions.
 - (i) Solutions of barium chloride and sodium sulphate in water react to give insoluble barium sulphate and the solution of sodium chloride.
 - (ii) Sodium hydroxide solution (in water) reacts with hydrochloric acid solution (in water) to produce sodium chloride solution and water.

1.2 TYPES OF CHEMICAL REACTIONS

We have learnt in Class IX that during a chemical reaction atoms of one element do not change into those of another element. Nor do atoms disappear from the mixture or appear from elsewhere. Actually, chemical reactions involve the breaking and making of bonds between atoms to produce new substances. You will study about types of bonds formed between atoms in Chapters 3 and 4.

1.2.1 Combination Reaction

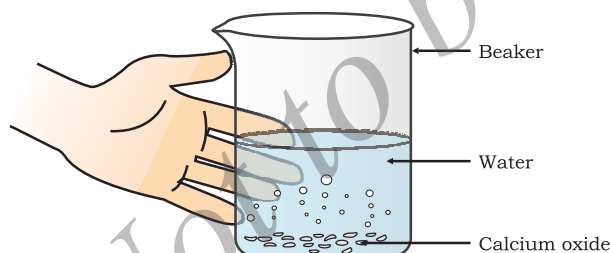
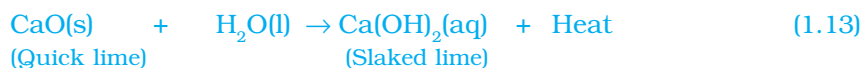

Figure 1.3
Formation of slaked lime by the reaction of calcium oxide with water

Activity 1.4

- Take a small amount of calcium oxide or quick lime in a beaker.
- Slowly add water to this.
- Touch the beaker as shown in Fig. 1.3.
- Do you feel any change in temperature?

Calcium oxide reacts vigorously with water to produce slaked lime (calcium hydroxide) releasing a large amount of heat.



In this reaction, calcium oxide and water combine to form a single product, calcium hydroxide. Such a reaction in which a single product is formed from two or more reactants is known as a combination reaction.

Do You Know?

A solution of slaked lime produced by the reaction 1.13 is used for whitewashing walls. Calcium hydroxide reacts slowly with the carbon dioxide in air to form a thin layer of calcium carbonate on the walls. Calcium carbonate is formed after two to three days of whitewashing and gives a shiny finish to the walls. It is interesting to note that the chemical formula for marble is also CaCO_3 .

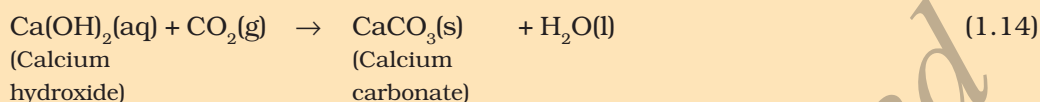

Let us discuss some more examples of combination reactions.

- (i) Burning of coal



- (ii) Formation of water from $\text{H}_2(\text{g})$ and $\text{O}_2(\text{g})$



In simple language we can say that when two or more substances (elements or compounds) combine to form a single product, the reactions are called combination reactions.

In Activity 1.4, we also observed that a large amount of heat is evolved. This makes the reaction mixture warm. Reactions in which heat is released along with the formation of products are called exothermic chemical reactions.

Other examples of exothermic reactions are –

- (i) Burning of natural gas



- (ii) Do you know that respiration is an exothermic process?

We all know that we need energy to stay alive. We get this energy from the food we eat. During digestion, food is broken down into simpler substances. For example, rice, potatoes and bread contain carbohydrates. These carbohydrates are broken down to form glucose. This glucose combines with oxygen in the cells of our body and provides energy. The special name of this reaction is respiration, the process of which you will study in Chapter 6.

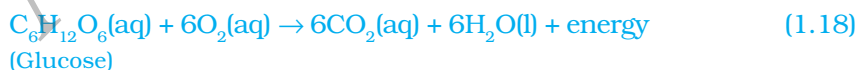

- (iii) The decomposition of vegetable matter into compost is also an example of an exothermic reaction.

Identify the type of the reaction taking place in Activity 1.1, where heat is given out along with the formation of a single product.

1.2.2 Decomposition Reaction

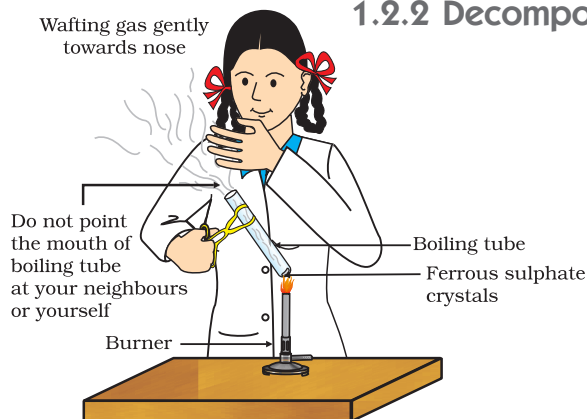
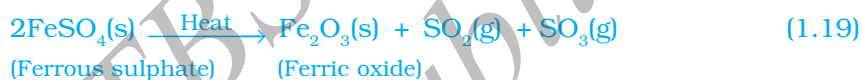

Figure 1.4
Correct way of heating the boiling tube containing crystals of ferrous sulphate and of smelling the odour

Activity 1.5

- Take about 2 g ferrous sulphate crystals in a dry boiling tube.
- Note the colour of the ferrous sulphate crystals.
- Heat the boiling tube over the flame of a burner or spirit lamp as shown in Fig. 1.4.
- Observe the colour of the crystals after heating.

Have you noticed that the green colour of the ferrous sulphate crystals has changed? You can also smell the characteristic odour of burning sulphur.



In this reaction you can observe that a single reactant breaks down to give simpler products. This is a decomposition reaction. Ferrous sulphate crystals ($\text{FeSO}_4 \cdot 7\text{H}_2\text{O}$) lose water when heated and the colour of the crystals changes. It then decomposes to ferric oxide (Fe_2O_3), sulphur dioxide (SO_2) and sulphur trioxide (SO_3). Ferric oxide is a solid, while SO_2 and SO_3 are gases.

Decomposition of calcium carbonate to calcium oxide and carbon dioxide on heating is an important decomposition reaction used in various industries. Calcium oxide is called lime or quick lime. It has many uses – one is in the manufacture of cement. When a decomposition reaction is carried out by heating, it is called thermal decomposition.

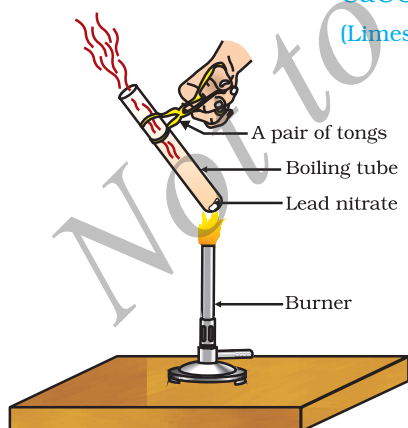
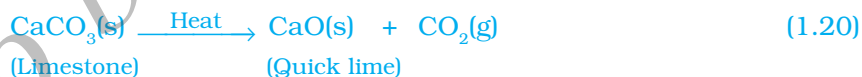

Figure 1.5
Heating of lead nitrate and emission of nitrogen dioxide

Another example of a thermal decomposition reaction is given in Activity 1.6.

Activity 1.6

- Take about 2 g lead nitrate powder in a boiling tube.
- Hold the boiling tube with a pair of tongs and heat it over a flame, as shown in Fig. 1.5.
- What do you observe? Note down the change, if any.

You will observe the emission of brown fumes. These fumes are of nitrogen dioxide (NO_2). The reaction that takes place is –



Let us perform some more decomposition reactions as given in Activities 1.7 and 1.8.

Activity 1.7

- Take a plastic mug. Drill two holes at its base and fit rubber stoppers in these holes. Insert carbon electrodes in these rubber stoppers as shown in Fig. 1.6.
 - Connect these electrodes to a 6 volt battery.
 - Fill the mug with water such that the electrodes are immersed. Add a few drops of dilute sulphuric acid to the water.
 - Take two test tubes filled with water and invert them over the two carbon electrodes.
 - Switch on the current and leave the apparatus undisturbed for some time.
 - You will observe the formation of bubbles at both the electrodes. These bubbles displace water in the test tubes.
 - Is the volume of the gas collected the same in both the test tubes?
 - Once the test tubes are filled with the respective gases, remove them carefully.
 - Test these gases one by one by bringing a burning candle close to the mouth of the test tubes.
- CAUTION:** This step must be performed carefully by the teacher.
- What happens in each case?
 - Which gas is present in each test tube?

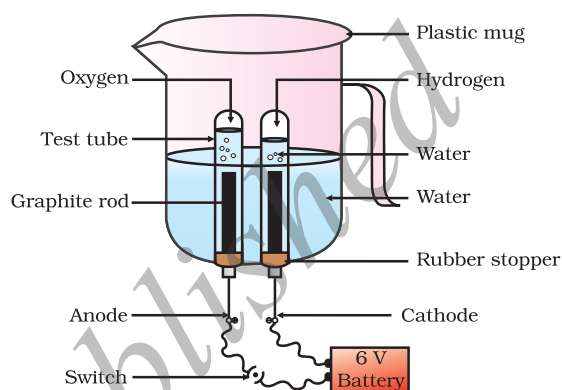

Figure 1.6
Electrolysis of water

Activity 1.8

- Take about 2 g silver chloride in a china dish.
- What is its colour?
- Place this china dish in sunlight for some time (Fig. 1.7).
- Observe the colour of the silver chloride after some time.

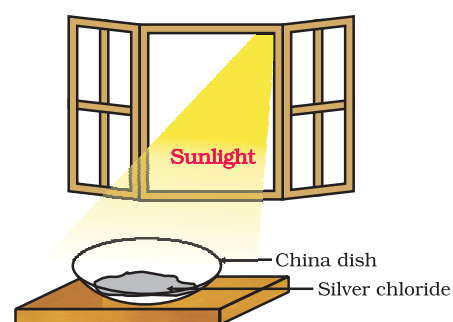

Figure 1.7
Silver chloride turns grey in sunlight to form silver metal

You will see that white silver chloride turns grey in sunlight. This is due to the decomposition of silver chloride into silver and chlorine by light.



Silver bromide also behaves in the same way.



The above reactions are used in black and white photography. What form of energy is causing these decomposition reactions?

We have seen that the decomposition reactions require energy either in the form of heat, light or electricity for breaking down the reactants. Reactions in which energy is absorbed are known as endothermic reactions.

Carry out the following Activity

Take about 2 g barium hydroxide in a test tube. Add 1 g of ammonium chloride and mix with the help of a glass rod. Touch the bottom of the test tube with your palm. What do you feel? Is this an exothermic or endothermic reaction?

Q U E S T I O N S

1. A solution of a substance 'X' is used for whitewashing.
 - (i) Name the substance 'X' and write its formula.
 - (ii) Write the reaction of the substance 'X' named in (i) above with water.
2. Why is the amount of gas collected in one of the test tubes in Activity 1.7 double of the amount collected in the other? Name this gas.

1.2.3 Displacement Reaction

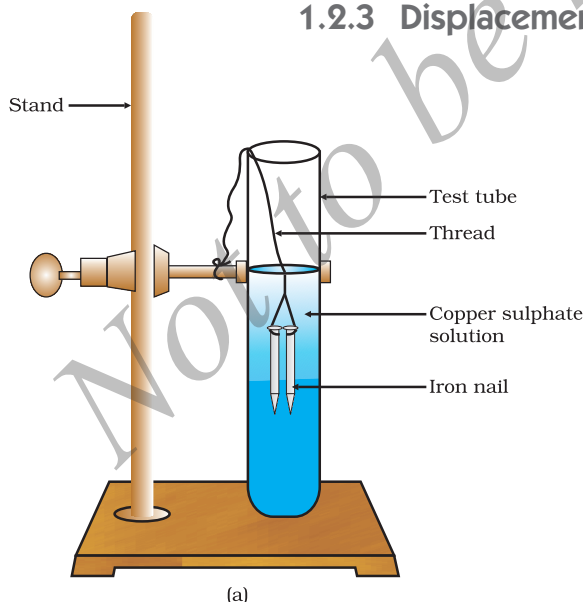

Figure 1.8
(a) Iron nails dipped in copper sulphate solution

Activity 1.9

- Take three iron nails and clean them by rubbing with sand paper.
- Take two test tubes marked as (A) and (B). In each test tube, take about 10 mL copper sulphate solution.
- Tie two iron nails with a thread and immerse them carefully in the copper sulphate solution in test tube B for about 20 minutes [Fig. 1.8 (a)]. Keep one iron nail aside for comparison.
- After 20 minutes, take out the iron nails from the copper sulphate solution.
- Compare the intensity of the blue colour of copper sulphate solutions in test tubes (A) and (B) [Fig. 1.8 (b)].
- Also, compare the colour of the iron nails dipped in the copper sulphate solution with the one kept aside [Fig. 1.8 (b)].

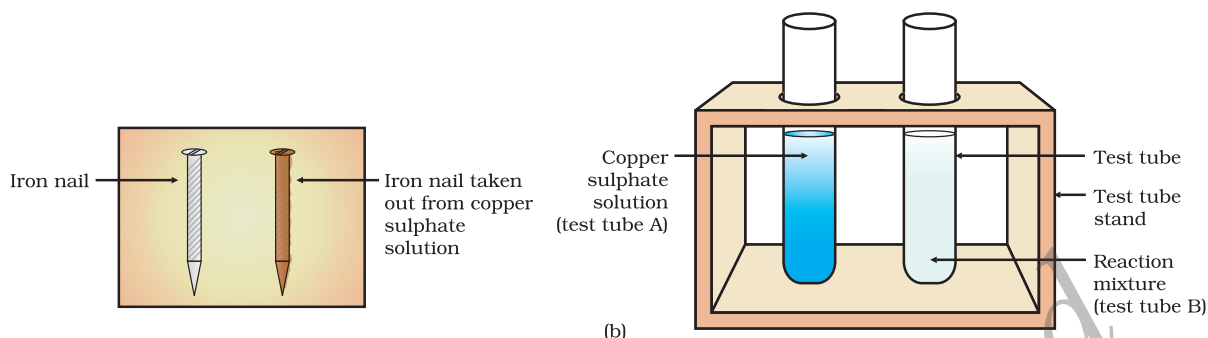

Figure 1.8 (b) Iron nails and copper sulphate solutions compared before and after the experiment

Why does the iron nail become brownish in colour and the blue colour of copper sulphate solution fades?

The following chemical reaction takes place in this Activity –



In this reaction, iron has displaced or removed another element, copper, from copper sulphate solution. This reaction is known as displacement reaction.

Other examples of displacement reactions are

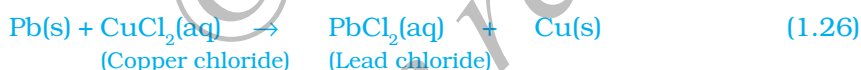
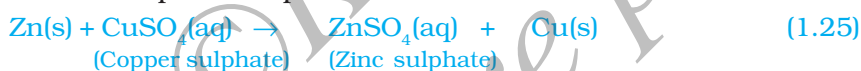

Zinc and lead are more reactive elements than copper. They displace copper from its compounds.

1.2.4 Double Displacement Reaction

Activity 1.10

- Take about 3 mL of sodium sulphate solution in a test tube.
- In another test tube, take about 3 mL of barium chloride solution.
- Mix the two solutions (Fig. 1.9).
- What do you observe?

You will observe that a white substance, which is insoluble in water, is formed. This insoluble substance formed is known as a precipitate. Any reaction that produces a precipitate can be called a precipitation reaction.

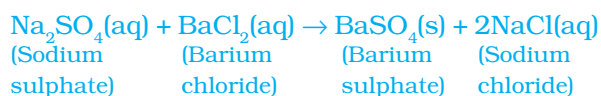

(1.27)

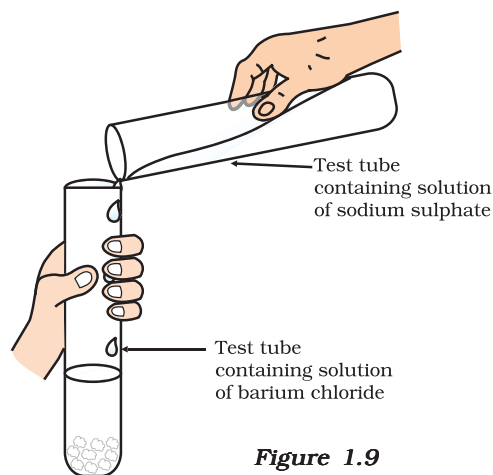

Figure 1.9
Formation of barium sulphate and sodium chloride

What causes this? The white precipitate of BaSO_4 is formed by the reaction of SO_4^{2-} and Ba^{2+} . The other product formed is sodium chloride which remains in the solution. Such reactions in which there is an exchange of ions between the reactants are called double displacement reactions.

Recall Activity 1.2, where you have mixed the solutions of lead(II) nitrate and potassium iodide.

- What was the colour of the precipitate formed? Can you name the compound precipitated?
- Write the balanced chemical equation for this reaction.
- Is this also a double displacement reaction?

1.2.5 Oxidation and Reduction

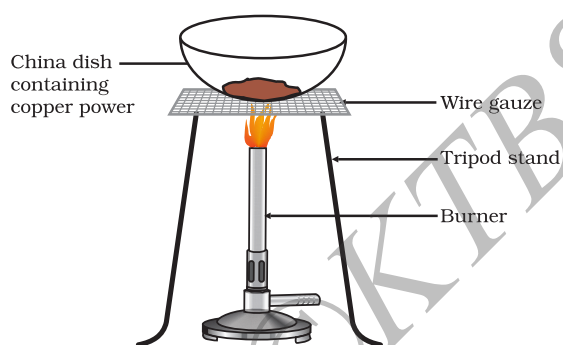

Figure 1.10
Oxidation of copper to copper oxide

Activity 1.11

- Heat a china dish containing about 1 g copper powder (Fig. 1.10).
- What do you observe?

The surface of copper powder becomes coated with black copper(II) oxide. Why has this black substance formed?

This is because oxygen is added to copper and copper oxide is formed.



If hydrogen gas is passed over this heated material (CuO), the black coating on the surface turns brown as the reverse reaction takes place and copper is obtained.



If a substance gains oxygen during a reaction, it is said to be oxidised. If a substance loses oxygen during a reaction, it is said to be reduced.

During this reaction (1.29), the copper(II) oxide is losing oxygen and is being reduced. The hydrogen is gaining oxygen and is being oxidised. In other words, one reactant gets oxidised while the other gets reduced during a reaction. Such reactions are called oxidation-reduction reactions or redox reactions.



Some other examples of redox reactions are:



In reaction (1.31) carbon is oxidised to CO and ZnO is reduced to Zn. In reaction (1.32) HCl is oxidised to Cl₂ whereas MnO₂ is reduced to MnCl₂.

From the above examples we can say that if a substance gains oxygen or loses hydrogen during a reaction, it is oxidised. If a substance loses oxygen or gains hydrogen during a reaction, it is reduced.

Recall Activity 1.1, where a magnesium ribbon burns with a dazzling flame in air (oxygen) and changes into a white substance, magnesium oxide. Is magnesium being oxidised or reduced in this reaction?

1.3 HAVE YOU OBSERVED THE EFFECTS OF OXIDATION REACTIONS IN EVERYDAY LIFE?

1.3.1 Corrosion

You must have observed that iron articles are shiny when new, but get coated with a reddish brown powder when left for some time. This process is commonly known as rusting of iron. Some other metals also get tarnished in this manner. Have you noticed the colour of the coating formed on copper and silver? When a metal is attacked by substances around it such as moisture, acids, etc., it is said to corrode and this process is called corrosion. The black coating on silver and the green coating on copper are other examples of corrosion.

Corrosion causes damage to car bodies, bridges, iron railings, ships and to all objects made of metals, specially those of iron. Corrosion of iron is a serious problem. Every year an enormous amount of money is spent to replace damaged iron. You will learn more about corrosion in Chapter 3.

1.3.2 Rancidity

Have you ever tasted or smelt the fat/oil containing food materials left for a long time?

When fats and oils are oxidised, they become rancid and their smell and taste change. Usually substances which prevent oxidation (antioxidants) are added to foods containing fats and oil. Keeping food in air tight containers helps to slow down oxidation. Do you know that chips manufacturers usually flush bags of chips with gas such as nitrogen to prevent the chips from getting oxidised ?

Q U E S T I O N S

1. Why does the colour of copper sulphate solution change when an iron nail is dipped in it?
2. Give an example of a double displacement reaction other than the one given in Activity 1.10.
3. Identify the substances that are oxidised and the substances that are reduced in the following reactions.
 - (i) $4\text{Na(s)} + \text{O}_2\text{(g)} \rightarrow 2\text{Na}_2\text{O(s)}$
 - (ii) $\text{CuO(s)} + \text{H}_2\text{(g)} \rightarrow \text{Cu(s)} + \text{H}_2\text{O(l)}$



What you have learnt

- A complete chemical equation represents the reactants, products and their physical states symbolically.
- A chemical equation is balanced so that the numbers of atoms of each type involved in a chemical reaction are the same on the reactant and product sides of the equation. Equations must always be balanced.
- In a combination reaction two or more substances combine to form a new single substance.
- Decomposition reactions are opposite to combination reactions. In a decomposition reaction, a single substance decomposes to give two or more substances.
- Reactions in which heat is given out along with the products are called exothermic reactions.
- Reactions in which energy is absorbed are known as endothermic reactions.
- When an element displaces another element from its compound, a displacement reaction occurs.
- Two different atoms or groups of atoms (ions) are exchanged in double displacement reactions.
- Precipitation reactions produce insoluble salts.
- Reactions also involve the gain or loss of oxygen or hydrogen by substances. Oxidation is the gain of oxygen or loss of hydrogen. Reduction is the loss of oxygen or gain of hydrogen.

EXERCISES

1. Which of the statements about the reaction below are incorrect?

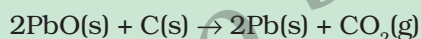

- (a) Lead is getting reduced.
 - (b) Carbon dioxide is getting oxidised.
 - (c) Carbon is getting oxidised.
 - (d) Lead oxide is getting reduced.
- (i) (a) and (b)
 - (ii) (a) and (c)
 - (iii) (a), (b) and (c)
 - (iv) all

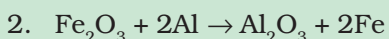

The above reaction is an example of a

- (a) combination reaction.
- (b) double displacement reaction.

- (c) decomposition reaction.
- (d) displacement reaction.
3. What happens when dilute hydrochloric acid is added to iron fillings? Tick the correct answer.
- (a) Hydrogen gas and iron chloride are produced.
- (b) Chlorine gas and iron hydroxide are produced.
- (c) No reaction takes place.
- (d) Iron salt and water are produced.
4. What is a balanced chemical equation? Why should chemical equations be balanced?
5. Translate the following statements into chemical equations and then balance them.
- (a) Hydrogen gas combines with nitrogen to form ammonia.
- (b) Hydrogen sulphide gas burns in air to give water and sulphur dioxide.
- (c) Barium chloride reacts with aluminium sulphate to give aluminium chloride and a precipitate of barium sulphate.
- (d) Potassium metal reacts with water to give potassium hydroxide and hydrogen gas.
6. Balance the following chemical equations.
- (a) $\text{HNO}_3 + \text{Ca(OH)}_2 \rightarrow \text{Ca(NO}_3)_2 + \text{H}_2\text{O}$
- (b) $\text{NaOH} + \text{H}_2\text{SO}_4 \rightarrow \text{Na}_2\text{SO}_4 + \text{H}_2\text{O}$
- (c) $\text{NaCl} + \text{AgNO}_3 \rightarrow \text{AgCl} + \text{NaNO}_3$
- (d) $\text{BaCl}_2 + \text{H}_2\text{SO}_4 \rightarrow \text{BaSO}_4 + \text{HCl}$
7. Write the balanced chemical equations for the following reactions.
- (a) Calcium hydroxide + Carbon dioxide \rightarrow Calcium carbonate + Water
- (b) Zinc + Silver nitrate \rightarrow Zinc nitrate + Silver
- (c) Aluminium + Copper chloride \rightarrow Aluminium chloride + Copper
- (d) Barium chloride + Potassium sulphate \rightarrow Barium sulphate + Potassium chloride
8. Write the balanced chemical equation for the following and identify the type of reaction in each case.
- (a) Potassium bromide(aq) + Barium iodide(aq) \rightarrow Potassium iodide(aq) + Barium bromide(s)
- (b) Zinc carbonate(s) \rightarrow Zinc oxide(s) + Carbon dioxide(g)
- (c) Hydrogen(g) + Chlorine(g) \rightarrow Hydrogen chloride(g)
- (d) Magnesium(s) + Hydrochloric acid(aq) \rightarrow Magnesium chloride(aq) + Hydrogen(g)
9. What does one mean by exothermic and endothermic reactions? Give examples.
10. Why is respiration considered an exothermic reaction? Explain.
11. Why are decomposition reactions called the opposite of combination reactions? Write equations for these reactions.

12. Write one equation each for decomposition reactions where energy is supplied in the form of heat, light or electricity.
13. What is the difference between displacement and double displacement reactions? Write equations for these reactions.
14. In the refining of silver, the recovery of silver from silver nitrate solution involved displacement by copper metal. Write down the reaction involved.
15. What do you mean by a precipitation reaction? Explain by giving examples.
16. Explain the following in terms of gain or loss of oxygen with two examples each.
 - (a) Oxidation
 - (b) Reduction
17. A shiny brown coloured element 'X' on heating in air becomes black in colour. Name the element 'X' and the black coloured compound formed.
18. Why do we apply paint on iron articles?
19. Oil and fat containing food items are flushed with nitrogen. Why?
20. Explain the following terms with one example each.
 - (a) Corrosion
 - (b) Rancidity

Group Activity

Perform the following activity.

- Take four beakers and label them as A, B, C and D.
- Put 25 mL of water in A, B and C beakers and copper sulphate solution in beaker D.
- Measure and record the temperature of each liquid contained in the beakers above.
- Add two spatulas of potassium sulphate, ammonium nitrate, anhydrous copper sulphate and fine iron filings to beakers A, B, C and D respectively and stir.
- Finally measure and record the temperature of each of the mixture above.

Find out which reactions are exothermic and which ones are endothermic in nature.

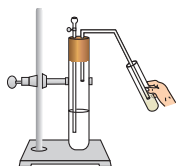

CHAPTER 2

Acids, Bases and Salts



You have learnt in your previous classes that the sour and bitter tastes of food are due to acids and bases, respectively, present in them.

If someone in the family is suffering from a problem of acidity after overeating, which of the following would you suggest as a remedy—lemon juice, vinegar or baking soda solution?

- Which property did you think of while choosing the remedy? Surely you must have used your knowledge about the ability of acids and bases to nullify each other's effect.
- Recall how we tested sour and bitter substances without tasting them.

You already know that acids are sour in taste and change the colour of blue litmus to red, whereas, bases are bitter and change the colour of the red litmus to blue. Litmus is a natural indicator, turmeric is another such indicator. Have you noticed that a stain of curry on a white cloth becomes reddish-brown when soap, which is basic in nature, is scrubbed on it? It turns yellow again when the cloth is washed with plenty of water. You can also use synthetic indicators such as methyl orange and phenolphthalein to test for acids and bases.

In this Chapter, we will study the reactions of acids and bases, how acids and bases cancel out each other's effects and many more interesting things that we use and see in our day-to-day life.

Do You Know?

Litmus solution is a purple dye, which is extracted from lichen, a plant belonging to the division Thallophyta, and is commonly used as an indicator. When the litmus solution is neither acidic nor basic, its colour is purple. There are many other natural materials like red cabbage leaves, turmeric, coloured petals of some flowers such as *Hydrangea*, *Petunia* and *Geranium*, which indicate the presence of acid or base in a solution. These are called acid-base indicators or sometimes simply indicators.

Q U E S T I O N

1. You have been provided with three test tubes. One of them contains distilled water and the other two contain an acidic solution and a basic solution, respectively. If you are given only red litmus paper, how will you identify the contents of each test tube?



2.1 UNDERSTANDING THE CHEMICAL PROPERTIES OF ACIDS AND BASES

2.1.1 Acids and Bases in the Laboratory

Activity 2.1

- Collect the following solutions from the science laboratory—hydrochloric acid (HCl), sulphuric acid (H_2SO_4), nitric acid (HNO_3), acetic acid (CH_3COOH), sodium hydroxide (NaOH), calcium hydroxide [$Ca(OH)_2$], potassium hydroxide (KOH), magnesium hydroxide [$Mg(OH)_2$], and ammonium hydroxide (NH_4OH).
- Put a drop of each of the above solutions on a watch-glass one by one and test with a drop of the indicators shown in Table 2.1.
- What change in colour did you observe with red litmus, blue litmus, phenolphthalein and methyl orange solutions for each of the solutions taken?
- Tabulate your observations in Table 2.1.

Table 2.1

Sample solution	Red litmus solution	Blue litmus solution	Phenolphthalein solution	Methyl orange solution

These indicators tell us whether a substance is acidic or basic by change in colour. There are some substances whose odour changes in acidic or basic media. These are called olfactory indicators. Let us try out some of these indicators.

Activity 2.2

- Take some finely chopped onions in a plastic bag along with some strips of clean cloth. Tie up the bag tightly and leave overnight in the fridge. The cloth strips can now be used to test for acids and bases.
- Take two of these cloth strips and check their odour.
- Keep them on a clean surface and put a few drops of dilute HCl solution on one strip and a few drops of dilute NaOH solution on the other.

- Rinse both cloth strips with water and again check their odour.
- Note your observations.
- Now take some dilute vanilla essence and clove oil and check their odour.
- Take some dilute HCl solution in one test tube and dilute NaOH solution in another. Add a few drops of dilute vanilla essence to both test tubes and shake well. Check the odour once again and record changes in odour, if any.
- Similarly, test the change in the odour of clove oil with dilute HCl and dilute NaOH solutions and record your observations.

Which of these – vanilla, onion and clove, can be used as olfactory indicators on the basis of your observations?

Let us do some more activities to understand the chemical properties of acids and bases.

2.1.2 How do Acids and Bases React with Metals?

Activity 2.3

CAUTION: This activity needs the teacher's assistance.

- Set the apparatus as shown in Fig. 2.1.
- Take about 5 mL of dilute sulphuric acid in a test tube and add a few pieces of zinc granules to it.
- What do you observe on the surface of zinc granules?
- Pass the gas being evolved through the soap solution.
- Why are bubbles formed in the soap solution?
- Take a burning candle near a gas filled bubble.
- What do you observe?
- Repeat this Activity with some more acids like HCl, HNO₃ and CH₃COOH.
- Are the observations in all the cases the same or different?

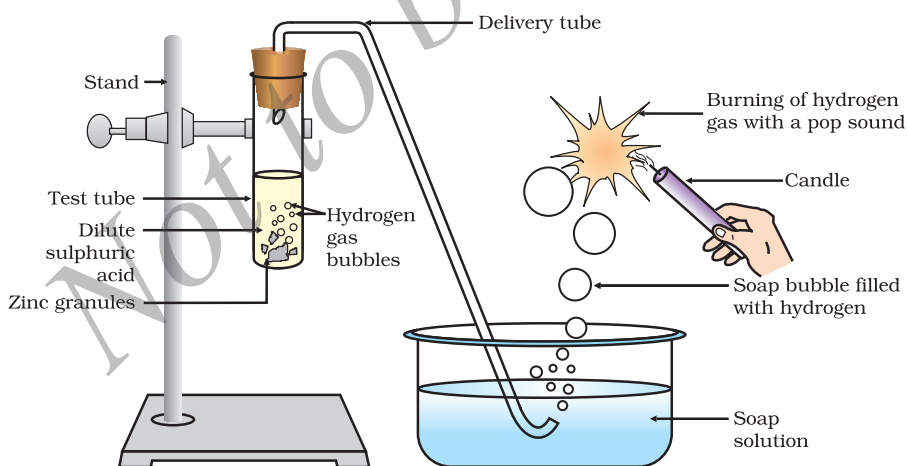

Figure 2.1 Reaction of zinc granules with dilute sulphuric acid and testing hydrogen gas by burning

Note that the metal in the above reactions displaces hydrogen atoms from the acids as hydrogen gas and forms a compound called a salt. Thus, the reaction of a metal with an acid can be summarised as –



Can you now write the equations for the reactions you have observed?

Activity 2.4

- Place a few pieces of granulated zinc metal in a test tube.
- Add 2 mL of sodium hydroxide solution and warm the contents of the test tube.
- Repeat the rest of the steps as in Activity 2.3 and record your observations.

The reaction that takes place can be written as follows.

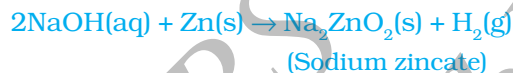

You find again that hydrogen is formed in the reaction. However, such reactions are not possible with all metals.

2.1.3 How do Metal Carbonates and Metal Hydrogencarbonates React with Acids?

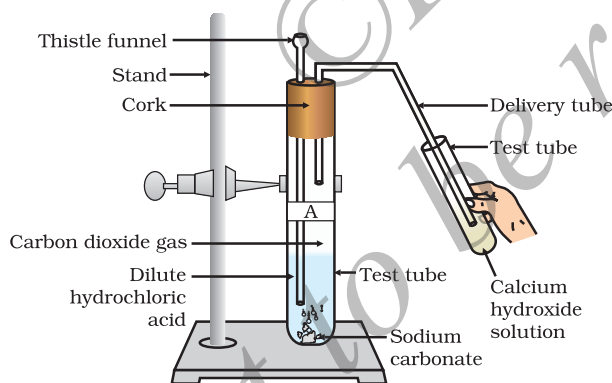

Figure 2.2
Passing carbon dioxide gas through calcium hydroxide solution

Activity 2.5

- Take two test tubes, label them as A and B.
- Take about 0.5 g of sodium carbonate (Na_2CO_3) in test tube A and about 0.5 g of sodium hydrogencarbonate (NaHCO_3) in test tube B.
- Add about 2 mL of dilute HCl to both the test tubes.
- What do you observe?
- Pass the gas produced in each case through lime water (calcium hydroxide solution) as shown in Fig. 2.2 and record your observations.

The reactions occurring in the above Activity are written as –



On passing the carbon dioxide gas evolved through lime water,

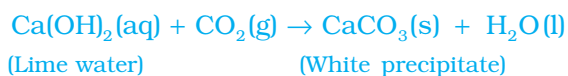

On passing excess carbon dioxide the following reaction takes place:

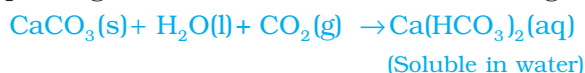

Limestone, chalk and marble are different forms of calcium carbonate. All metal carbonates and hydrogencarbonates react with acids to give a corresponding salt, carbon dioxide and water.

Thus, the reaction can be summarised as –



2.1.4 How do Acids and Bases React with each other?

Activity 2.6

- Take about 2 mL of dilute NaOH solution in a test tube and add two drops of phenolphthalein solution.
- What is the colour of the solution?
- Add dilute HCl solution to the above solution drop by drop.
- Is there any colour change for the reaction mixture?
- Why did the colour of phenolphthalein change after the addition of an acid?
- Now add a few drops of NaOH to the above mixture.
- Does the pink colour of phenolphthalein reappear?
- Why do you think this has happened?

In the above Activity, we have observed that the effect of a base is nullified by an acid and vice-versa. The reaction taking place is written as –

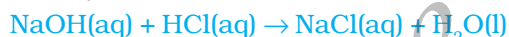

The reaction between an acid and a base to give a salt and water is known as a neutralisation reaction. In general, a neutralisation reaction can be written as –



2.1.5 Reaction of Metallic Oxides with Acids

Activity 2.7

- Take a small amount of copper oxide in a beaker and add dilute hydrochloric acid slowly while stirring.
- Note the colour of the solution. What has happened to the copper oxide?

You will notice that the colour of the solution becomes blue-green and the copper oxide dissolves. The blue-green colour of the solution is due to the formation of copper(II) chloride in the reaction. The general reaction between a metal oxide and an acid can be written as –



Now write and balance the equation for the above reaction. Since metallic oxides react with acids to give salts and water, similar to the reaction of a base with an acid, metallic oxides are said to be basic oxides.

2.1.6 Reaction of a Non-metallic Oxide with Base

You saw the reaction between carbon dioxide and calcium hydroxide (lime water) in Activity 2.5. Calcium hydroxide, which is a base, reacts with carbon dioxide to produce a salt and water. Since this is similar to the reaction between a base and an acid, we can conclude that non-metallic oxides are acidic in nature.

Q U E S T I O N S

1. Why should curd and sour substances not be kept in brass and copper vessels?
2. Which gas is usually liberated when an acid reacts with a metal? Illustrate with an example. How will you test for the presence of this gas?
3. Metal compound A reacts with dilute hydrochloric acid to produce effervescence. The gas evolved extinguishes a burning candle. Write a balanced chemical equation for the reaction if one of the compounds formed is calcium chloride.

2.2 WHAT DO ALL ACIDS AND ALL BASES HAVE IN COMMON?

In Section 2.1 we have seen that all acids have similar chemical properties. What leads to this similarity in properties? We saw in Activity 2.3 that all acids generate hydrogen gas on reacting with metals, so hydrogen seems to be common to all acids. Let us perform an Activity to investigate whether all compounds containing hydrogen are acidic.

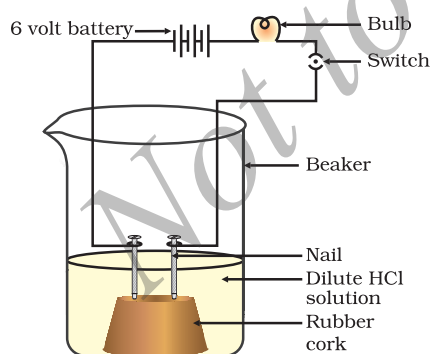

Figure 2.3
Acid solution in water conducts electricity

Activity 2.8

- Take solutions of glucose, alcohol, hydrochloric acid, sulphuric acid, etc.
- Fix two nails on a cork, and place the cork in a 100 mL beaker.
- Connect the nails to the two terminals of a 6 volt battery through a bulb and a switch, as shown in Fig. 2.3.
- Now pour some dilute HCl in the beaker and switch on the current.
- Repeat with dilute sulphuric acid.
- What do you observe?
- Repeat the experiment separately with glucose and alcohol solutions. What do you observe now?
- Does the bulb glow in all cases?

The bulb will start glowing in the case of acids, as shown in Fig. 2.3. But you will observe that glucose and alcohol solutions do not conduct electricity. Glowing of the bulb indicates that there is a flow of electric current through the solution. The electric current is carried through the acidic solution by ions.

Acids contain H^+ ion as cation and anion such as Cl^- in HCl , NO_3^- in HNO_3 , SO_4^{2-} in H_2SO_4 , CH_3COO^- in CH_3COOH . Since the cation present in acids is H^+ , this suggests that acids produce hydrogen ions, $H^+(aq)$, in solution, which are responsible for their acidic properties.

Repeat the same Activity using alkalis such as sodium hydroxide, calcium hydroxide, etc. What can you conclude from the results of this Activity?

2.2.1 What Happens to an Acid or a Base in a Water Solution?

Do acids produce ions only in aqueous solution? Let us test this.

Activity 2.9

- Take about 1g solid $NaCl$ in a clean and dry test tube and set up the apparatus as shown in Fig. 2.4.
- Add some concentrated sulphuric acid to the test tube.
- What do you observe? Is there a gas coming out of the delivery tube?
- Test the gas evolved successively with dry and wet blue litmus paper.
- In which case does the litmus paper change colour?
- On the basis of the above Activity, what do you infer about the acidic character of:
 - (i) dry HCl gas
 - (ii) HCl solution?

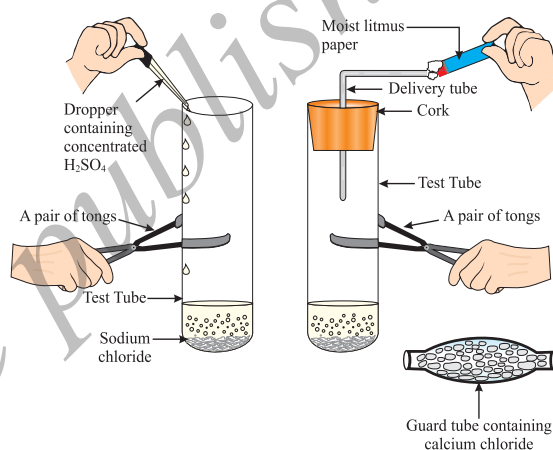

Figure 2.4 Preparation of HCl gas

Note to teachers: If the climate is very humid, you will have to pass the gas produced through a guard tube (drying tube) containing calcium chloride to dry the gas.

This experiment suggests that hydrogen ions in HCl are produced in the presence of water. The separation of H^+ ion from HCl molecules cannot occur in the absence of water.



Hydrogen ions cannot exist alone, but they exist after combining with water molecules. Thus hydrogen ions must always be shown as $H^+(aq)$ or hydronium ion (H_3O^+).



We have seen that acids give H_3O^+ or $H^+(aq)$ ion in water. Let us see what happens when a base is dissolved in water.





Bases generate hydroxide (OH⁻) ions in water. Bases which are soluble in water are called alkalis.

Do You Know?

All bases do not dissolve in water. An alkali is a base that dissolves in water. They are soapy to touch, bitter and corrosive. Never taste or touch them as they may cause harm. Which of the bases in the Table 2.1 are alkalis?

Now as we have identified that all acids generate H⁺(aq) and all bases generate OH⁻(aq), we can view the neutralisation reaction as follows –



Let us see what is involved when water is mixed with an acid or a base.



Figure 2.5
Warning sign displayed on containers containing concentrated acids and bases

Activity 2.10

- Take 10 mL water in a beaker.
- Add a few drops of concentrated H₂SO₄ to it and swirl the beaker slowly.
- Touch the base of the beaker.
- Is there a change in temperature?
- Is this an exothermic or endothermic process?
- Repeat the above Activity with sodium hydroxide pellets and record your observations.

The process of dissolving an acid or a base in water is a highly exothermic one. Care must be taken while mixing concentrated nitric acid or sulphuric acid with water. The acid must always be added slowly to water with constant stirring. If water is added to a concentrated acid, the heat generated may cause the mixture to splash out and cause burns. The glass container may also break due to excessive local heating. Look out for the warning sign (shown in Fig. 2.5) on the can of concentrated sulphuric acid and on the bottle of sodium hydroxide pellets.

Mixing an acid or base with water results in decrease in the concentration of ions (H₃O⁺/OH⁻) per unit volume. Such a process is called dilution and the acid or the base is said to be diluted.

Q U E S T I O N S

1. Why do HCl, HNO₃, etc., show acidic characters in aqueous solutions while solutions of compounds like alcohol and glucose do not show acidic character?
2. Why does an aqueous solution of an acid conduct electricity?
3. Why does dry HCl gas not change the colour of the dry litmus paper?
4. While diluting an acid, why is it recommended that the acid should be added to water and not water to the acid?
5. How is the concentration of hydronium ions (H₃O⁺) affected when a solution of an acid is diluted?
6. How is the concentration of hydroxide ions (OH⁻) affected when excess base is dissolved in a solution of sodium hydroxide?

2.3 HOW STRONG ARE ACID OR BASE SOLUTIONS?

We know how acid-base indicators can be used to distinguish between an acid and a base. We have also learnt in the previous section about dilution and decrease in concentration of H⁺ or OH⁻ ions in solutions. Can we quantitatively find the amount of these ions present in a solution? Can we judge how strong a given acid or base is?

We can do this by making use of a universal indicator, which is a mixture of several indicators. The universal indicator shows different colours at different concentrations of hydrogen ions in a solution.

A scale for measuring hydrogen ion concentration in a solution, called pH scale has been developed. The p in pH stands for '*potenz*' in German, meaning power. On the pH scale we can measure pH generally from 0 (very acidic) to 14 (very alkaline). pH should be thought of simply as a number which indicates the acidic or basic nature of a solution. Higher the hydronium ion concentration, lower is the pH value.

The pH of a neutral solution is 7. Values less than 7 on the pH scale represent an acidic solution. As the pH value increases from 7 to 14, it represents an increase in OH⁻ ion concentration in the solution, that is, increase in the strength of alkali (Fig. 2.6). Generally paper impregnated with the universal indicator is used for measuring pH.

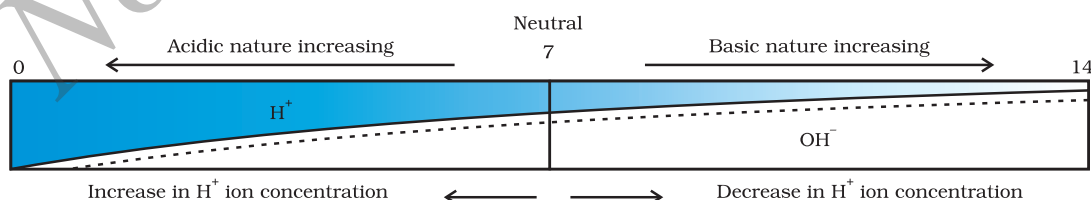

Figure 2.6 Variation of pH with the change in concentration of H⁺(aq) and OH⁻(aq) ions

Activity 2.11

- Test the pH values of solutions given in Table 2.2.
- Record your observations.
- What is the nature of each substance on the basis of your observations?

Table 2.2

S. No.	Solution	Colour of pH paper	Approximate pH value	Nature of substance
1	Saliva (before meal)			
2	Saliva (after meal)			
3	Lemon juice			
4	Colourless aerated drink			
5	Carrot juice			
6	Coffee			
7	Tomato juice			
8	Tap water			
9	1M NaOH			
10	1M HCl			

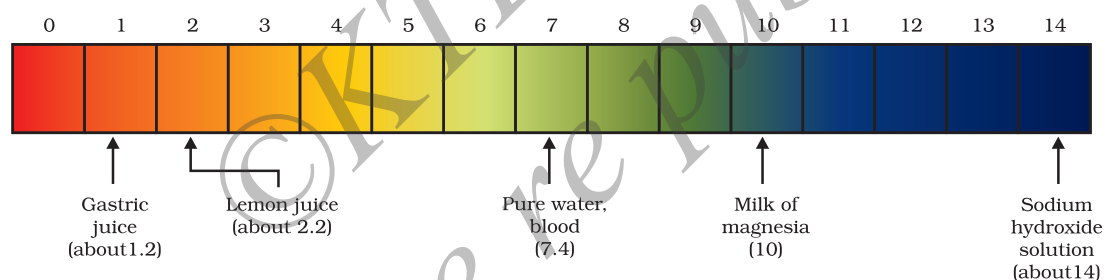

Figure 2.7 pH of some common substances shown on a pH paper (colours are only a rough guide)

The strength of acids and bases depends on the number of H^+ ions and OH^- ions produced, respectively. If we take hydrochloric acid and acetic acid of the same concentration, say one molar, then these produce different amounts of hydrogen ions. Acids that give rise to more H^+ ions are said to be strong acids, and acids that give less H^+ ions are said to be weak acids. Can you now say what weak and strong bases are?

2.3.1 Importance of pH in Everyday Life

Are plants and animals pH sensitive?

Our body works within the pH range of 7.0 to 7.8. Living organisms can survive only in a narrow range of pH change. When pH of rain water is less than 5.6, it is called acid rain. When acid rain flows into the rivers, it lowers the pH of the river water. The survival of aquatic life in such rivers becomes difficult.

Acids in other planets

The atmosphere of venus is made up of thick white and yellowish clouds of sulphuric acid. Do you think life can exist on this planet?

What is the pH of the soil in your backyard?

Plants require a specific pH range for their healthy growth. To find out the pH required for the healthy growth of a plant, you can collect the soil from various places and check the pH in the manner described below in Activity 2.12. Also, you can note down which plants are growing in the region from which you have collected the soil.

Activity 2.12

- Put about 2 g soil in a test tube and add 5 mL water to it.
- Shake the contents of the test tube.
- Filter the contents and collect the filtrate in a test tube.
- Check the pH of this filtrate with the help of universal indicator paper.
- What can you conclude about the ideal soil pH for the growth of plants in your region?

pH in our digestive system

It is very interesting to note that our stomach produces hydrochloric acid. It helps in the digestion of food without harming the stomach. During indigestion the stomach produces too much acid and this causes pain and irritation. To get rid of this pain, people use bases called antacids. One such remedy must have been suggested by you at the beginning of this Chapter. These antacids neutralise the excess acid. Magnesium hydroxide (Milk of magnesia), a mild base, is often used for this purpose.

pH change as the cause of tooth decay

Tooth decay starts when the pH of the mouth is lower than 5.5. Tooth enamel, made up of calcium hydroxyapatite (a crystalline form of calcium phosphate) is the hardest substance in the body. It does not dissolve in water, but is corroded when the pH in the mouth is below 5.5. Bacteria present in the mouth produce acids by degradation of sugar and food particles remaining in the mouth after eating. The best way to prevent this is to clean the mouth after eating food. Using toothpastes, which are generally basic, for cleaning the teeth can neutralise the excess acid and prevent tooth decay.

Self defence by animals and plants through chemical warfare

Have you ever been stung by a honey-bee? Bee-sting leaves an acid which causes pain and irritation. Use of a mild base like baking soda on the stung area gives relief. Stinging hair of nettle leaves inject methanoic acid causing burning pain.



Nature provides neutralisation options

Nettle is a herbaceous plant which grows in the wild. Its leaves have stinging hair, which cause painful stings when touched accidentally. This is due to the methanoic acid secreted by them. A traditional remedy is rubbing the area with the leaf of the dock plant, which often grows beside the nettle in the wild. Can you guess the nature of the dock plant? So next time you know what to look out for if you accidentally touch a nettle plant while trekking. Are you aware of any other effective traditional remedies for such stings?

Table 2.3 Some naturally occurring acids

Natural source	Acid	Natural source	Acid
Vinegar	Acetic acid	Sour milk (Curd)	Lactic acid
Orange	Citric acid	Lemon	Citric acid
Tamarind	Tartaric acid	Ant sting	Methanoic acid
Tomato	Oxalic acid	Nettle sting	Methanoic acid

Q U E S T I O N S

1. You have two solutions, A and B. The pH of solution A is 6 and pH of solution B is 8. Which solution has more hydrogen ion concentration? Which of this is acidic and which one is basic?
2. What effect does the concentration of $H^+(aq)$ ions have on the nature of the solution?
3. Do basic solutions also have $H^+(aq)$ ions? If yes, then why are these basic?
4. Under what soil condition do you think a farmer would treat the soil of his fields with quick lime (calcium oxide) or slaked lime (calcium hydroxide) or chalk (calcium carbonate)?



2.4 MORE ABOUT SALTS

In the previous sections we have seen the formation of salts during various reactions. Let us understand more about their preparation, properties and uses.

2.4.1 Family of Salts

Activity 2.13

- Write the chemical formulae of the salts given below. Potassium sulphate, sodium sulphate, calcium sulphate, magnesium sulphate, copper sulphate, sodium chloride, sodium nitrate, sodium carbonate and ammonium chloride.

- Identify the acids and bases from which the above salts may be obtained.
- Salts having the same positive or negative radicals are said to belong to a family. For example, NaCl and Na₂SO₄ belong to the family of sodium salts. Similarly, NaCl and KCl belong to the family of chloride salts. How many families can you identify among the salts given in this Activity?

2.4.2 pH of Salts

Activity 2.14

- Collect the following salt samples – sodium chloride, potassium nitrate, aluminium chloride, zinc sulphate, copper sulphate, sodium acetate, sodium carbonate and sodium hydrogencarbonate (some other salts available can also be taken).
- Check their solubility in water (use distilled water only).
- Check the action of these solutions on litmus and find the pH using a pH paper.
- Which of the salts are acidic, basic or neutral?
- Identify the acid or base used to form the salt.
- Report your observations in Table 2.4.

Salts of a strong acid and a strong base are neutral with pH value of 7. On the other hand, salts of a strong acid and weak base are acidic with pH value less than 7 and those of a strong base and weak acid are basic in nature, with pH value more than 7.

Table 2.4

Salt	pH	Acid used	Base used

2.4.3 Chemicals from Common Salt

By now you have learnt that the salt formed by the combination of hydrochloric acid and sodium hydroxide solution is called sodium chloride. This is the salt that you use in food. You must have observed in the above Activity that it is a neutral salt.

Seawater contains many salts dissolved in it. Sodium chloride is separated from these salts. Deposits of solid salt are also found in several parts of the world. These large crystals are often brown due to impurities. This is called rock salt. Beds of rock salt were formed when seas of bygone ages dried up. Rock salt is mined like coal.

You must have heard about Mahatma Gandhi's *Dandi March*. Did you know that sodium chloride was such an important symbol in our struggle for freedom?



Common salt — A raw material for chemicals

The common salt thus obtained is an important raw material for various materials of daily use, such as sodium hydroxide, baking soda, washing soda, bleaching powder and many more. Let us see how one substance is used for making all these different substances.

Sodium hydroxide

When electricity is passed through an aqueous solution of sodium chloride (called brine), it decomposes to form sodium hydroxide. The process is called the chlor-alkali process because of the products formed—chlor for chlorine and alkali for sodium hydroxide.



Chlorine gas is given off at the anode, and hydrogen gas at the cathode. Sodium hydroxide solution is formed near the cathode. The three products produced in this process are all useful. Figure 2.8 shows the different uses of these products.

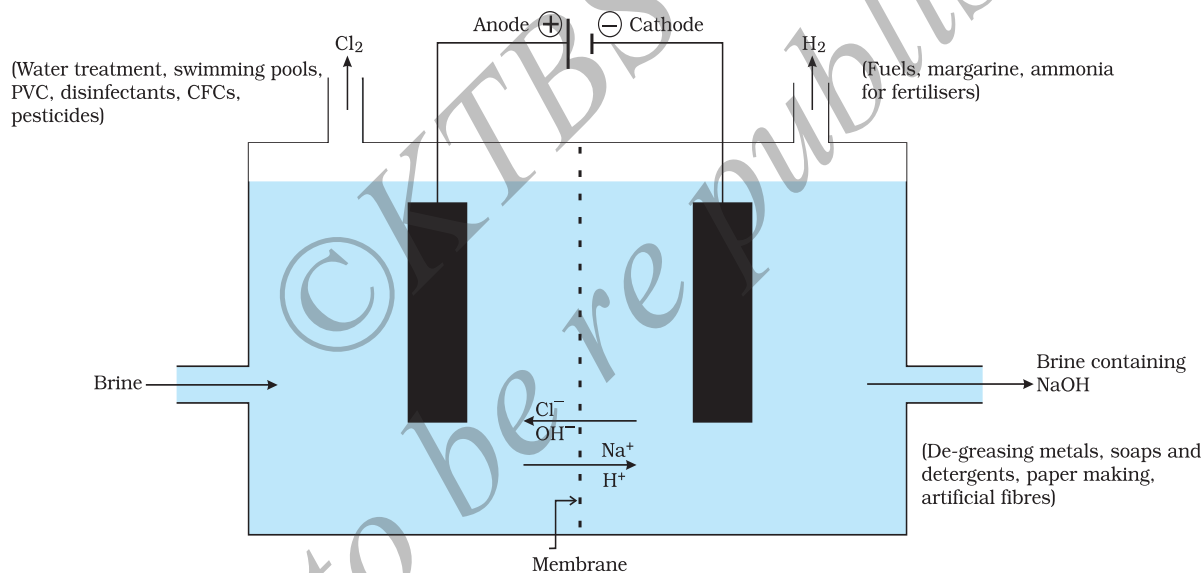

Figure 2.8 Important products from the chlor-alkali process

Bleaching powder

You have already come to know that chlorine is produced during the electrolysis of aqueous sodium chloride (brine). This chlorine gas is used for the manufacture of bleaching powder. Bleaching powder is produced by the action of chlorine on dry slaked lime [Ca(OH)₂]. Bleaching powder is represented as CaOCl₂, though the actual composition is quite complex.



Bleaching powder is used –

- (i) for bleaching cotton and linen in the textile industry, for bleaching wood pulp in paper factories and for bleaching washed clothes in laundry;
- (ii) as an oxidising agent in many chemical industries; and
- (iii) to make drinking water free from germs.

Baking soda

The baking soda is commonly used in the kitchen for making tasty crispy pakoras, etc. Sometimes it is added for faster cooking. The chemical name of the compound is sodium hydrogencarbonate (NaHCO_3). It is produced using sodium chloride as one of the raw materials.

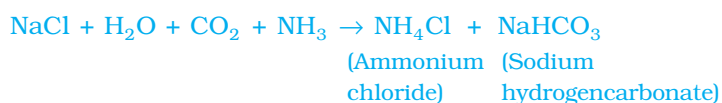

Did you check the pH of sodium hydrogencarbonate in Activity 2.14? Can you correlate why it can be used to neutralise an acid? It is a mild non-corrosive basic salt. The following reaction takes place when it is heated during cooking –

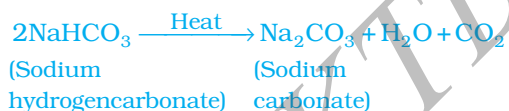

Sodium hydrogencarbonate has got various uses in the household.

Uses of Baking soda

- (i) For making baking powder, which is a mixture of baking soda (sodium hydrogencarbonate) and a mild edible acid such as tartaric acid. When baking powder is heated or mixed in water, the following reaction takes place –

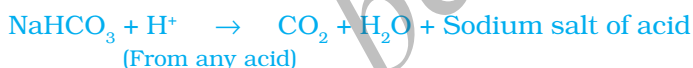

Carbon dioxide produced during the reaction can cause bread or cake to rise making them soft and spongy.

- (ii) Sodium hydrogencarbonate is also an ingredient in antacids. Being alkaline, it neutralises excess acid in the stomach and provides relief.
- (iii) It is also used in soda-acid fire extinguishers.

Washing soda

Another chemical that can be obtained from sodium chloride is $\text{Na}_2\text{CO}_3 \cdot 10\text{H}_2\text{O}$ (washing soda). You have seen above that sodium carbonate can be obtained by heating baking soda; recrystallisation of sodium carbonate gives washing soda. It is also a basic salt.

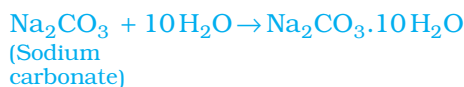

What does $10\text{H}_2\text{O}$ signify? Does it make Na_2CO_3 wet? We will address this question in the next section.

Sodium carbonate and sodium hydrogencarbonate are useful chemicals for many industrial processes as well.

Uses of washing soda

- (i) Sodium carbonate (washing soda) is used in glass, soap and paper industries.
- (ii) It is used in the manufacture of sodium compounds such as borax.
- (iii) Sodium carbonate can be used as a cleaning agent for domestic purposes.
- (iv) It is used for removing permanent hardness of water.

2.4.4 Are the Crystals of Salts really Dry?

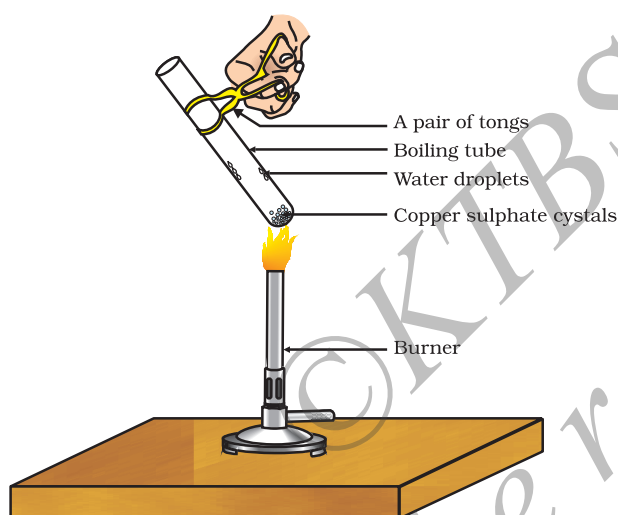

Figure 2.9
Removing water
of crystallisation

Copper sulphate crystals which seem to be dry contain water of crystallisation. When we heat the crystals, this water is removed and the salt turns white.

If you moisten the crystals again with water, you will find that blue colour of the crystals reappears.

Water of crystallisation is the fixed number of water molecules present in one formula unit of a salt. Five water molecules are present in one formula unit of copper sulphate. Chemical formula for hydrated copper sulphate is $\text{CuSO}_4 \cdot 5\text{H}_2\text{O}$. Now you would be able to answer the question whether the molecule of $\text{Na}_2\text{CO}_3 \cdot 10\text{H}_2\text{O}$ is wet.

One other salt, which possesses water of crystallisation is gypsum. It has two water molecules as water of crystallisation. It has the chemical formula $\text{CaSO}_4 \cdot 2\text{H}_2\text{O}$. Let us look into the use of this salt.

Plaster of Paris

On heating gypsum at 373 K, it loses water molecules and becomes calcium sulphate hemihydrate ($\text{CaSO}_4 \cdot \frac{1}{2}\text{H}_2\text{O}$). This is called Plaster of

Activity 2.15

- Heat a few crystals of copper sulphate in a dry boiling tube.
- What is the colour of the copper sulphate after heating?
- Do you notice water droplets in the boiling tube? Where have these come from?
- Add 2-3 drops of water on the sample of copper sulphate obtained after heating.
- What do you observe? Is the blue colour of copper sulphate restored?

Paris, the substance which doctors use as plaster for supporting fractured bones in the right position. Plaster of Paris is a white powder and on mixing with water, it changes to gypsum once again giving a hard solid mass.

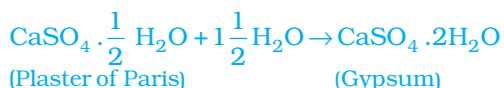

Note that only half a water molecule is shown to be attached as water of crystallisation. How can you get half a water molecule? It is written in this form because two formula units of CaSO_4 share one molecule of water. Plaster of Paris is used for making toys, materials for decoration and for making surfaces smooth. Try to find out why is calcium sulphate hemihydrate called 'Plaster of Paris' ?

Q U E S T I O N S

1. What is the common name of the compound CaOCl_2 ?
2. Name the substance which on treatment with chlorine yields bleaching powder.
3. Name the sodium compound which is used for softening hard water.
4. What will happen if a solution of sodium hydrocarbonate is heated? Give the equation of the reaction involved.
5. Write an equation to show the reaction between Plaster of Paris and water.

What you have learnt

- Acid-base indicators are dyes or mixtures of dyes which are used to indicate the presence of acids and bases.
- Acidic nature of a substance is due to the formation of $\text{H}^+(\text{aq})$ ions in solution. Formation of $\text{OH}^-(\text{aq})$ ions in solution is responsible for the basic nature of a substance.
- When an acid reacts with a metal, hydrogen gas is evolved and a corresponding salt is formed.
- When a base reacts with a metal, along with the evolution of hydrogen gas a salt is formed which has a negative ion composed of the metal and oxygen.
- When an acid reacts with a metal carbonate or metal hydrogencarbonate, it gives the corresponding salt, carbon dioxide gas and water.
- Acidic and basic solutions in water conduct electricity because they produce hydrogen and hydroxide ions respectively.

- The strength of an acid or an alkali can be tested by using a scale called the pH scale (0-14) which gives the measure of hydrogen ion concentration in a solution.
- A neutral solution has a pH of exactly 7, while an acidic solution has a pH less than 7 and a basic solution a pH more than 7.
- Living beings carry out their metabolic activities within an optimal pH range.
- Mixing concentrated acids or bases with water is a highly exothermic process.
- Acids and bases neutralise each other to form corresponding salts and water.
- Water of crystallisation is the fixed number of water molecules present in one formula unit of a salt.
- Salts have various uses in everyday life and in industries.

E X E R C I S E S

1. A solution turns red litmus blue, its pH is likely to be
(a) 1 (b) 4 (c) 5 (d) 10
2. A solution reacts with crushed egg-shells to give a gas that turns lime-water milky. The solution contains
(a) NaCl (b) HCl (c) LiCl (d) KCl
3. 10 mL of a solution of NaOH is found to be completely neutralised by 8 mL of a given solution of HCl. If we take 20 mL of the same solution of NaOH, the amount HCl solution (the same solution as before) required to neutralise it will be
(a) 4 mL (b) 8 mL (c) 12 mL (d) 16 mL
4. Which one of the following types of medicines is used for treating indigestion?
(a) Antibiotic
(b) Analgesic
(c) Antacid
(d) Antiseptic
5. Write word equations and then balanced equations for the reaction taking place when –
(a) dilute sulphuric acid reacts with zinc granules.
(b) dilute hydrochloric acid reacts with magnesium ribbon.
(c) dilute sulphuric acid reacts with aluminium powder.
(d) dilute hydrochloric acid reacts with iron filings.
6. Compounds such as alcohols and glucose also contain hydrogen but are not categorised as acids. Describe an Activity to prove it.
7. Why does distilled water not conduct electricity, whereas rain water does?

8. Why do acids not show acidic behaviour in the absence of water?
9. Five solutions A,B,C,D and E when tested with universal indicator showed pH as 4, 1, 11, 7 and 9, respectively. Which solution is
- neutral?
 - strongly alkaline?
 - strongly acidic?
 - weakly acidic?
 - weakly alkaline?
- Arrange the pH in increasing order of hydrogen-ion concentration.
10. Equal lengths of magnesium ribbons are taken in test tubes A and B. Hydrochloric acid (HCl) is added to test tube A, while acetic acid (CH_3COOH) is added to test tube B. Amount and concentration taken for both the acids are same. In which test tube will the fizzing occur more vigorously and why?
11. Fresh milk has a pH of 6. How do you think the pH will change as it turns into curd? Explain your answer.
12. A milkman adds a very small amount of baking soda to fresh milk.
- Why does he shift the pH of the fresh milk from 6 to slightly alkaline?
 - Why does this milk take a long time to set as curd?
13. Plaster of Paris should be stored in a moisture-proof container. Explain why?
14. What is a neutralisation reaction? Give two examples.
15. Give two important uses of washing soda and baking soda.

Group Activity

(I) Prepare your own indicator

- Crush beetroot in a mortar.
- Add sufficient water to obtain the extract.
- Filter the extract by the procedure learnt by you in earlier classes.
- Collect the filtrate to test the substances you may have tasted earlier.
- Arrange four test tubes in a test tube stand and label them as A,B,C and D. Pour 2 mL each of lemon juice solution, soda-water, vinegar and baking soda solution in them respectively.
- Put 2-3 drops of the beetroot extract in each test tube and note the colour change if any. Write your observation in a Table.
- You can prepare indicators by using other natural materials like extracts of red cabbage leaves, coloured petals of some flowers such as *Petunia*, *Hydrangea* and *Geranium*.

(II) Preparing a soda-acid fire extinguisher

The reaction of acids with metal hydrogencarbonates is used in the fire extinguishers which produce carbon dioxide.

- Take 20 mL of sodium hydrogencarbonate (NaHCO_3) solution in a wash-bottle.
- Suspend an ignition tube containing dilute sulphuric acid in the wash-bottle (Fig. 2.10).
- Close the mouth of the wash-bottle.
- Tilt the wash-bottle so that the acid from the ignition tube mixes with the sodium hydrogencarbonate solution below.
- You will notice discharge coming out of the nozzle.
- Direct this discharge on a burning candle. What happens?

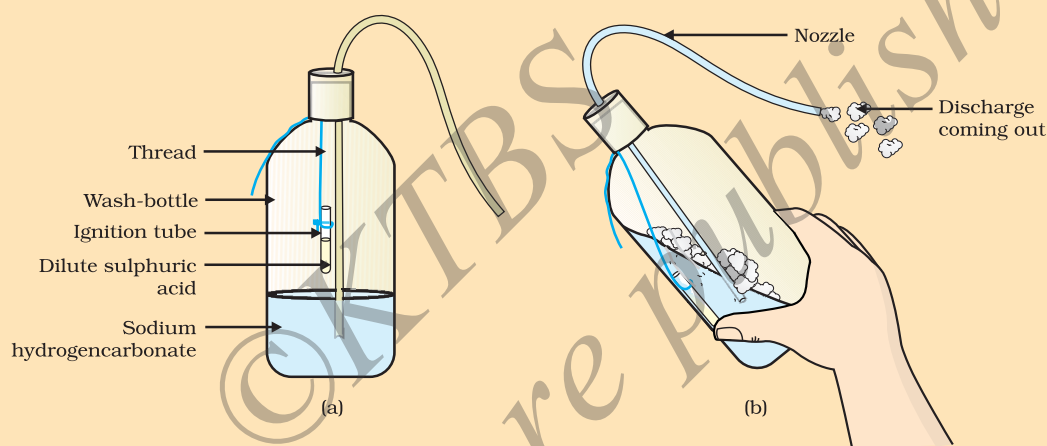
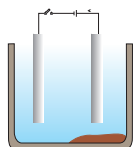

Figure 2.10 (a) Ignition tube containing dilute sulphuric acid suspended in a wash-bottle containing sodium hydrogencarbonate, (b) Discharge coming out of the nozzle

CHAPTER 3



Metals and Non-metals



In Class IX you have learnt about various elements. You have seen that elements can be classified as metals or non-metals on the basis of their properties.

- Think of some uses of metals and non-metals in your daily life.
- What properties did you think of while categorising elements as metals or non-metals?
- How are these properties related to the uses of these elements?

Let us look at some of these properties in detail.

3.1 PHYSICAL PROPERTIES

3.1.1 Metals

The easiest way to start grouping substances is by comparing their physical properties. Let us study this with the help of the following activities. For performing Activities 3.1 to 3.6, collect the samples of following metals – iron, copper, aluminium, magnesium, sodium, lead, zinc and any other metal that is easily available.

Activity 3.1

- Take samples of iron, copper, aluminium and magnesium. Note the appearance of each sample.
- Clean the surface of each sample by rubbing them with sand paper and note their appearance again.

Metals, in their pure state, have a shining surface. This property is called metallic lustre.

Activity 3.2

- Take small pieces of iron, copper, aluminium, and magnesium. Try to cut these metals with a sharp knife and note your observations.
- Hold a piece of sodium metal with a pair of tongs. **CAUTION:** Always handle sodium metal with care. Dry it by pressing between the folds of a filter paper.
- Put it on a watch-glass and try to cut it with a knife.
- What do you observe?

You will find that metals are generally hard. The hardness varies from metal to metal.

Activity 3.3

- Take pieces of iron, zinc, lead and copper.
- Place any one metal on a block of iron and strike it four or five times with a hammer. What do you observe?
- Repeat with other metals.
- Record the change in the shape of these metals.

You will find that some metals can be beaten into thin sheets. This property is called malleability. Did you know that gold and silver are the most malleable metals?

Activity 3.4

- List the metals whose wires you have seen in daily life.

The ability of metals to be drawn into thin wires is called ductility. Gold is the most ductile metal. You will be surprised to know that a wire of about 2 km length can be drawn from one gram of gold.

It is because of their malleability and ductility that metals can be given different shapes according to our needs.

Can you name some metals that are used for making cooking vessels? Do you know why these metals are used for making vessels? Let us do the following Activity to find out the answer.

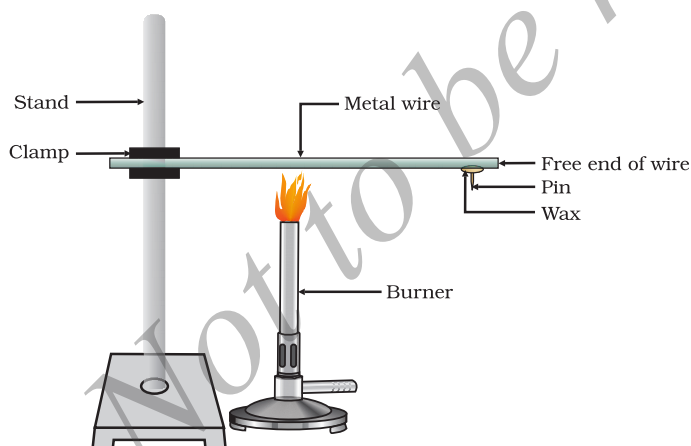

Figure 3.1
Metals are good conductors of heat.

Activity 3.5

- Take an aluminium or copper wire. Clamp this wire on a stand, as shown in Fig. 3.1.
- Fix a pin to the free end of the wire using wax.
- Heat the wire with a spirit lamp, candle or a burner near the place where it is clamped.
- What do you observe after some time?
- Note your observations. Does the metal wire melt?

The above activity shows that metals are good conductors of heat and have high melting points. The best conductors of heat are silver and copper. Lead and mercury are comparatively poor conductors of heat.

Do metals also conduct electricity? Let us find out.

Activity 3.6

- Set up an electric circuit as shown in Fig. 3.2.
- Place the metal to be tested in the circuit between terminals A and B as shown.
- Does the bulb glow? What does this indicate?

You must have seen that the wires that carry current in your homes have a coating of polyvinylchloride (PVC) or a rubber-like material. Why are electric wires coated with such substances?

What happens when metals strike a hard surface? Do they produce a sound? The metals that produce a sound on striking a hard surface are said to be sonorous. Can you now say why school bells are made of metals?

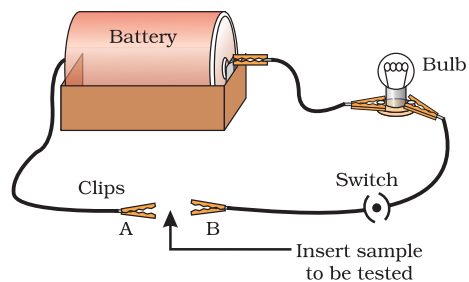

Figure 3.2
Metals are good conductors of electricity.

3.1.2 Non-metals

In the previous Class you have learnt that there are very few non-metals as compared to metals. Some of the examples of non-metals are carbon, sulphur, iodine, oxygen, hydrogen, etc. The non-metals are either solids or gases except bromine which is a liquid.

Do non-metals also have physical properties similar to that of metals? Let us find out.

Activity 3.7

- Collect samples of carbon (coal or graphite), sulphur and iodine.
- Carry out the Activities 3.1 to 3.4 and 3.6 with these non-metals and record your observations.

Compile your observations regarding metals and non-metals in Table 3.1.

Table 3.1

Element	Symbol	Type of surface	Hardness	Malleability	Ductility	Conducts Electricity	Sonority

On the bases of the observations recorded in Table 3.1, discuss the general physical properties of metals and non-metals in the class. You must have concluded that we cannot group elements according to their physical properties alone, as there are many exceptions. For example –

- All metals except mercury exist as solids at room temperature. In Activity 3.5, you have observed that metals have high melting

- points but gallium and caesium have very low melting points. These two metals will melt if you keep them on your palm.
- (ii) Iodine is a non-metal but it is lustrous.
 - (iii) Carbon is a non-metal that can exist in different forms. Each form is called an allotrope. Diamond, an allotrope of carbon, is the hardest natural substance known and has a very high melting and boiling point. Graphite, another allotrope of carbon, is a conductor of electricity.
 - (iv) Alkali metals (lithium, sodium, potassium) are so soft that they can be cut with a knife. They have low densities and low melting points.

Elements can be more clearly classified as metals and non-metals on the basis of their chemical properties.

Activity 3.8

- Take a magnesium ribbon and some sulphur powder.
- Burn the magnesium ribbon. Collect the ashes formed and dissolve them in water.
- Test the resultant solution with both red and blue litmus paper.
- Is the product formed on burning magnesium acidic or basic?
- Now burn sulphur powder. Place a test tube over the burning sulphur to collect the fumes produced.
- Add some water to the above test tube and shake.
- Test this solution with blue and red litmus paper.
- Is the product formed on burning sulphur acidic or basic?
- Can you write equations for these reactions?

Most non-metals produce acidic oxides when dissolve in water. On the other hand, most metals, give rise to basic oxides. You will be learning more about these metal oxides in the next section.

Q U E S T I O N S

1. Give an example of a metal which
 - (i) is a liquid at room temperature.
 - (ii) can be easily cut with a knife.
 - (iii) is the best conductor of heat.
 - (iv) is a poor conductor of heat.
2. Explain the meanings of malleable and ductile.



3.2 CHEMICAL PROPERTIES OF METALS

We will learn about the chemical properties of metals in the following Sections 3.2.1 to 3.2.4. For this, collect the samples of following metals – aluminium, copper, iron, lead, magnesium, zinc and sodium.

3.2.1 What happens when Metals are burnt in Air?

You have seen in Activity 3.8 that magnesium burns in air with a dazzling white flame. Do all metals react in the same manner? Let us check by performing the following Activity.

Activity 3.9

CAUTION: The following activity needs the teacher's assistance. It would be better if students wear eye protection.

- Hold any of the samples taken above with a pair of tongs and try burning over a flame. Repeat with the other metal samples.
- Collect the product if formed.
- Let the products and the metal surface cool down.
- Which metals burn easily?
- What flame colour did you observe when the metal burnt?
- How does the metal surface appear after burning?
- Arrange the metals in the decreasing order of their reactivity towards oxygen.
- Are the products soluble in water?

Almost all metals combine with oxygen to form metal oxides.

Metal + Oxygen → Metal oxide

For example, when copper is heated in air, it combines with oxygen to form copper(II) oxide, a black oxide.



Similarly, aluminium forms aluminium oxide.

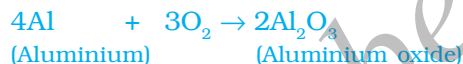

Recall from Chapter 2, how copper oxide reacts with hydrochloric acid. We have learnt that metal oxides are basic in nature. But some metal oxides, such as aluminium oxide, zinc oxide show both acidic as well as basic behaviour. Such metal oxides which react with both acids as well as bases to produce salts and water are known as amphoteric oxides. Aluminium oxide reacts in the following manner with acids and bases –

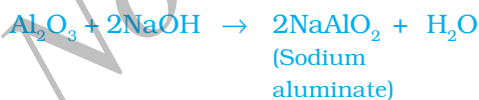

Most metal oxides are insoluble in water but some of these dissolve in water to form alkalis. Sodium oxide and potassium oxide dissolve in water to produce alkalis as follows –



We have observed in Activity 3.9 that all metals do not react with oxygen at the same rate. Different metals show different reactivities towards oxygen. Metals such as potassium and sodium react so vigorously that they catch fire if kept in the open. Hence, to protect them and to prevent accidental fires, they are kept immersed in kerosene oil. At ordinary temperature, the surfaces of metals such as magnesium, aluminium, zinc, lead, etc., are covered with a thin layer of oxide. The protective oxide layer prevents the metal from further oxidation. Iron does not burn on heating but iron filings burn vigorously when sprinkled in the flame of the burner. Copper does not burn, but the hot metal is coated with a black coloured layer of copper(II) oxide. Silver and gold do not react with oxygen even at high temperatures.

Do You Know?

Anodising is a process of forming a thick oxide layer of aluminium. Aluminium develops a thin oxide layer when exposed to air. This aluminium oxide coat makes it resistant to further corrosion. The resistance can be improved further by making the oxide layer thicker. During anodising, a clean aluminium article is made the anode and is electrolysed with dilute sulphuric acid. The oxygen gas evolved at the anode reacts with aluminium to make a thicker protective oxide layer. This oxide layer can be dyed easily to give aluminium articles an attractive finish.

After performing Activity 3.9, you must have observed that sodium is the most reactive of the samples of metals taken here. The reaction of magnesium is less vigorous implying that it is not as reactive as sodium. But burning in oxygen does not help us to decide about the reactivity of zinc, iron, copper or lead. Let us see some more reactions to arrive at a conclusion about the order of reactivity of these metals.

3.2.2 What happens when Metals react with Water?

Activity 3.10

CAUTION: This Activity needs the teacher's assistance.

- Collect the samples of the same metals as in Activity 3.9.
- Put small pieces of the samples separately in beakers half-filled with cold water.
- Which metals reacted with cold water? Arrange them in the increasing order of their reactivity with cold water.
- Did any metal produce fire on water?
- Does any metal start floating after some time?
- Put the metals that did not react with cold water in beakers half-filled with hot water.
- For the metals that did not react with hot water, arrange the apparatus as shown in Fig. 3.3 and observe their reaction with steam.
- Which metals did not react even with steam?
- Arrange the metals in the decreasing order of reactivity with water.

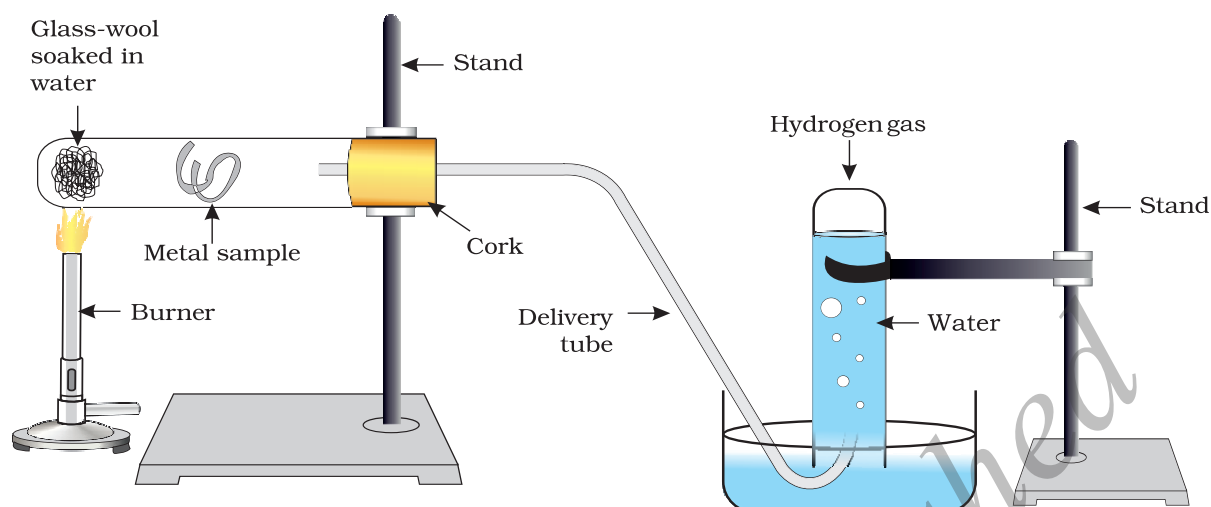
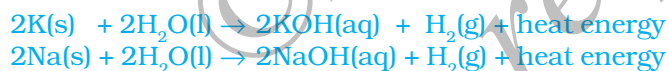

Figure 3.3 Action of steam on a metal

Metals react with water and produce a metal oxide and hydrogen gas. Metal oxides that are soluble in water dissolve in it to further form metal hydroxide. But all metals do not react with water.



Metals like potassium and sodium react violently with cold water. In case of sodium and potassium, the reaction is so violent and exothermic that the evolved hydrogen immediately catches fire.



The reaction of calcium with water is less violent. The heat evolved is not sufficient for the hydrogen to catch fire.



Calcium starts floating because the bubbles of hydrogen gas formed stick to the surface of the metal.

Magnesium does not react with cold water. It reacts with hot water to form magnesium hydroxide and hydrogen. It also starts floating due to the bubbles of hydrogen gas sticking to its surface.

Metals like aluminium, iron and zinc do not react either with cold or hot water. But they react with steam to form the metal oxide and hydrogen.

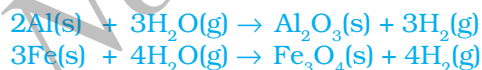

Metals such as lead, copper, silver and gold do not react with water at all.

3.2.3 What happens when Metals react with Acids?

You have already learnt that metals react with acids to give a salt and hydrogen gas.

Metal + Dilute acid \rightarrow Salt + Hydrogen

But do all metals react in the same manner? Let us find out.

Activity 3.11

- Collect all the metal samples except sodium and potassium again. If the samples are tarnished, rub them clean with sand paper. CAUTION: Do not take sodium and potassium as they react vigorously even with cold water.
- Put the samples separately in test tubes containing dilute hydrochloric acid.
- Suspend thermometers in the test tubes, so that their bulbs are dipped in the acid.
- Observe the rate of formation of bubbles carefully.
- Which metals reacted vigorously with dilute hydrochloric acid?
- With which metal did you record the highest temperature?
- Arrange the metals in the decreasing order of reactivity with dilute acids.

Write equations for the reactions of magnesium, aluminium, zinc and iron with dilute hydrochloric acid.

Hydrogen gas is not evolved when a metal reacts with nitric acid. It is because HNO_3 is a strong oxidising agent. It oxidises the H_2 produced to water and itself gets reduced to any of the nitrogen oxides (N_2O , NO , NO_2). But magnesium (Mg) and manganese (Mn) react with very dilute HNO_3 to evolve H_2 gas.

You must have observed in Activity 3.11, that the rate of formation of bubbles was the fastest in the case of magnesium. The reaction was also the most exothermic in this case. The reactivity decreases in the order $\text{Mg} > \text{Al} > \text{Zn} > \text{Fe}$. In the case of copper, no bubbles were seen and the temperature also remained unchanged. This shows that copper does not react with dilute HCl.

Do You Know?

Aqua regia, (Latin for 'royal water') is a freshly prepared mixture of concentrated hydrochloric acid and concentrated nitric acid in the ratio of 3:1. It can dissolve gold, even though neither of these acids can do so alone. *Aqua regia* is a highly corrosive, fuming liquid. It is one of the few reagents that is able to dissolve gold and platinum.

3.2.4 How do Metals react with Solutions of other Metal Salts?

Activity 3.12

- Take a clean wire of copper and an iron nail.
- Put the copper wire in a solution of iron sulphate and the iron nail in a solution of copper sulphate taken in test tubes (Fig. 3.4).
- Record your observations after 20 minutes.

- In which test tube did you find that a reaction has occurred?
- On what basis can you say that a reaction has actually taken place?
- Can you correlate your observations for the Activities 3.9, 3.10 and 3.11?
- Write a balanced chemical equation for the reaction that has taken place.
- Name the type of reaction.

Reactive metals can displace less reactive metals from their compounds in solution or molten form.

We have seen in the previous sections that all metals are not equally reactive. We checked the reactivity of various metals with oxygen, water and acids. But all metals do not react with these reagents. So we were not able to put all the metal samples we had collected in decreasing order of their reactivity. Displacement reactions studied in Chapter 1 give better evidence about the reactivity of metals. It is simple and easy if metal A displaces metal B from its solution, it is more reactive than B.



Which metal, copper or iron, is more reactive according to your observations in Activity 3.12?

3.2.5 The Reactivity Series

The reactivity series is a list of metals arranged in the order of their decreasing activities. After performing displacement experiments (Activities 1.9 and 3.12), the following series, (Table 3.2) known as the reactivity or activity series has been developed.

Table 3.2 Activity series : Relative reactivities of metals

K	Potassium		Most reactive
Na	Sodium		
Ca	Calcium		
Mg	Magnesium		
Al	Aluminium		
Zn	Zinc		Reactivity decreases
Fe	Iron		
Pb	Lead		
[H]	[Hydrogen]		
Cu	Copper		
Hg	Mercury		
Ag	Silver		
Au	Gold		Least reactive

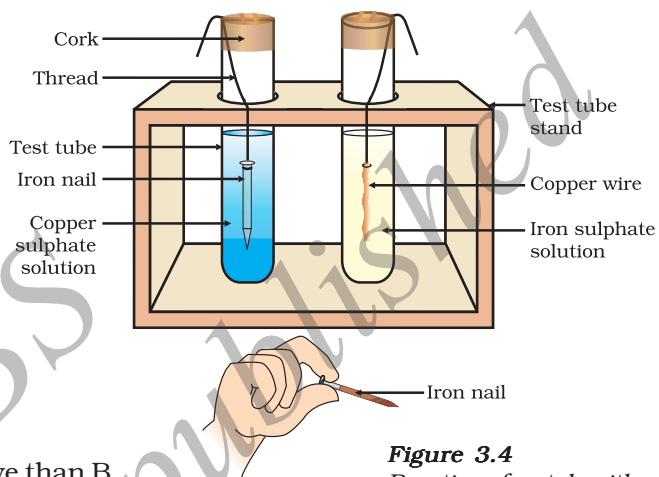

Figure 3.4
Reaction of metals with salt solutions

Q U E S T I O N S

- Why is sodium kept immersed in kerosene oil?
- Write equations for the reactions of
 - iron with steam
 - calcium and potassium with water
- Samples of four metals A, B, C and D were taken and added to the following solution one by one. The results obtained have been tabulated as follows.

Metal	Iron(II) sulphate	Copper(II) sulphate	Zinc sulphate	Silver nitrate
A	No reaction	Displacement		
B	Displacement		No reaction	
C	No reaction	No reaction	No reaction	Displacement
D	No reaction	No reaction	No reaction	No reaction

Use the Table above to answer the following questions about metals A, B, C and D.

- Which is the most reactive metal?
 - What would you observe if B is added to a solution of Copper(II) sulphate?
 - Arrange the metals A, B, C and D in the order of decreasing reactivity.
- Which gas is produced when dilute hydrochloric acid is added to a reactive metal? Write the chemical reaction when iron reacts with dilute H_2SO_4 .
 - What would you observe when zinc is added to a solution of iron(II) sulphate? Write the chemical reaction that takes place.

3.3 HOW DO METALS AND NON-METALS REACT?

In the above activities, you saw the reactions of metals with a number of reagents. Why do metals react in this manner? Let us recall what we learnt about the electronic configuration of elements in Class IX. We learnt that noble gases, which have a completely filled valence shell, show little chemical activity. We, therefore, explain the reactivity of elements as a tendency to attain a completely filled valence shell.

Let us have a look at the electronic configuration of noble gases and some metals and non-metals.

We can see from Table 3.3 that a sodium atom has one electron in its outermost shell. If it loses the electron from its M shell then its L shell now becomes the outermost shell and that has a stable octet. The nucleus of this atom still has 11 protons but the number of electrons has become 10, so there is a net positive charge giving us a sodium cation Na^+ . On the other hand chlorine has seven electrons in its outermost shell

Table 3.3 Electronic configurations of some elements

Type of element	Element	Atomic number	Number of electrons in shells			
			K	L	M	N
Noble gases	Helium (He)	2	2			
	Neon (Ne)	10	2	8		
	Argon (Ar)	18	2	8	8	
Metals	Sodium (Na)	11	2	8	1	
	Magnesium (Mg)	12	2	8	2	
	Aluminium (Al)	13	2	8	3	
	Potassium (K)	19	2	8	8	1
	Calcium (Ca)	20	2	8	8	2
Non-metals	Nitrogen (N)	7	2	5		
	Oxygen (O)	8	2	6		
	Fluorine (F)	9	2	7		
	Phosphorus (P)	15	2	8	5	
	Sulphur (S)	16	2	8	6	
	Chlorine (Cl)	17	2	8	7	

and it requires one more electron to complete its octet. If sodium and chlorine were to react, the electron lost by sodium could be taken up by chlorine. After gaining an electron, the chlorine atom gets a unit negative charge, because its nucleus has 17 protons and there are 18 electrons in its K, L and M shells. This gives us a chloride anion Cl^- . So both these elements can have a give-and-take relation between them as follows (Fig. 3.5).

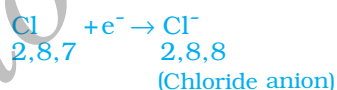
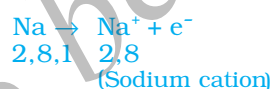
**Figure 3.5** Formation of sodium chloride

Sodium and chloride ions, being oppositely charged, attract each other and are held by strong electrostatic forces of attraction to exist as sodium chloride (NaCl). It should be noted that sodium chloride does not exist as molecules but aggregates of oppositely charged ions.

Let us see the formation of one more ionic compound, magnesium chloride (Fig. 3.6).

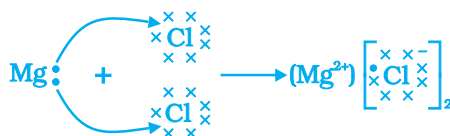
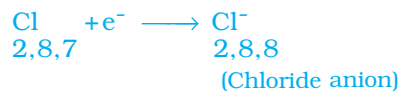
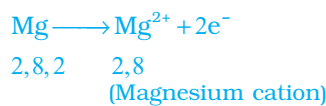

Figure 3.6 Formation of magnesium chloride

The compounds formed in this manner by the transfer of electrons from a metal to a non-metal are known as ionic compounds or electrovalent compounds. Can you name the cation and anion present in MgCl_2 ?

3.3.1 Properties of Ionic Compounds

To learn about the properties of ionic compounds, let us perform the following Activity:

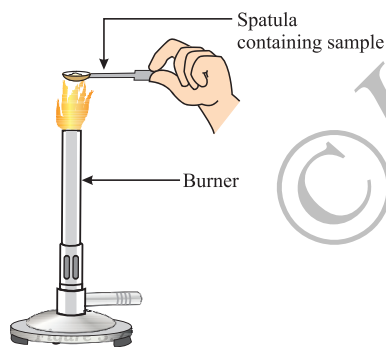

Figure 3.7
Heating a salt sample on a spatula

Activity 3.13

- Take samples of sodium chloride, potassium iodide, barium chloride or any other salt from the science laboratory.
- What is the physical state of these salts?
- Take a small amount of a sample on a metal spatula and heat directly on the flame (Fig. 3.7). Repeat with other samples.
- What did you observe? Did the samples impart any colour to the flame? Do these compounds melt?
- Try to dissolve the samples in water, petrol and kerosene. Are they soluble?
- Make a circuit as shown in Fig. 3.8 and insert the electrodes into a solution of one salt. What did you observe? Test the other salt samples too in this manner.
- What is your inference about the nature of these compounds?

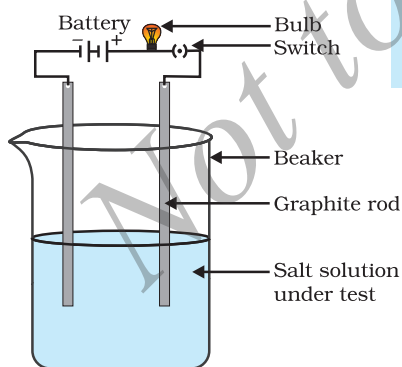

Figure 3.8
Testing the conductivity of a salt solution

Table 3.4 Melting and boiling points of some ionic compounds

Ionic compound	Melting point (K)	Boiling point (K)
NaCl	1074	1686
LiCl	887	1600
CaCl ₂	1045	1900
CaO	2850	3120
MgCl ₂	981	1685

You may have observed the following general properties for ionic compounds—

- (i) *Physical nature*: Ionic compounds are solids and are somewhat hard because of the strong force of attraction between the positive and negative ions. These compounds are generally brittle and break into pieces when pressure is applied.
- (ii) *Melting and Boiling points*: Ionic compounds have high melting and boiling points (see Table 3.4). This is because a considerable amount of energy is required to break the strong inter-ionic attraction.
- (iii) *Solubility*: Electrovalent compounds are generally soluble in water and insoluble in solvents such as kerosene, petrol, etc.
- (iv) *Conduction of Electricity*: The conduction of electricity through a solution involves the movement of charged particles. A solution of an ionic compound in water contains ions, which move to the opposite electrodes when electricity is passed through the solution. Ionic compounds in the solid state do not conduct electricity because movement of ions in the solid is not possible due to their rigid structure. But ionic compounds conduct electricity in the molten state. This is possible in the molten state since the electrostatic forces of attraction between the oppositely charged ions are overcome due to the heat. Thus, the ions move freely and conduct electricity.

Q U E S T I O N S

1.
 - (i) Write the electron-dot structures for sodium, oxygen and magnesium.
 - (ii) Show the formation of Na_2O and MgO by the transfer of electrons.
 - (iii) What are the ions present in these compounds?
2. Why do ionic compounds have high melting points?



3.4 OCCURRENCE OF METALS

The earth's crust is the major source of metals. Seawater also contains some soluble salts such as sodium chloride, magnesium chloride, etc. The elements or compounds, which occur naturally in the earth's crust, are known as minerals. At some places, minerals contain a very high percentage of a particular metal and the metal can be profitably extracted from it. These minerals are called ores.

3.4.1 Extraction of Metals

You have learnt about the reactivity series of metals. Having this knowledge, you can easily understand how a metal is extracted from its ore. Some metals are found in the earth's crust in the free state. Some are found in the form of their compounds. The metals at the bottom of the activity series are the least reactive. They are often found in a free

K	Electrolysis
Na	
Ca	
Mg	
Al	
Zn	Reduction using carbon
Fe	
Pb	
Cu	
Ag	Found in native state
Au	

Figure 3.9
Activity series and related metallurgy

state. For example, gold, silver, platinum and copper are found in the free state. Copper and silver are also found in the combined state as their sulphide or oxide ores. The metals at the top of the activity series (K, Na, Ca, Mg and Al) are so reactive that they are never found in nature as free elements. The metals in the middle of the activity series (Zn, Fe, Pb, etc.) are moderately reactive. They are found in the earth's crust mainly as oxides, sulphides or carbonates. You will find that the ores of many metals are oxides. This is because oxygen is a very reactive element and is very abundant on the earth.

Thus on the basis of reactivity, we can group the metals into the following three categories (Fig. 3.9) – (i) Metals of low reactivity; (ii) Metals of medium reactivity; (iii) Metals of high reactivity. Different techniques are to be used for obtaining the metals falling in each category.

Several steps are involved in the extraction of pure metal from ores. A summary of these steps is given in Fig.3.10. Each step is explained in detail in the following sections.

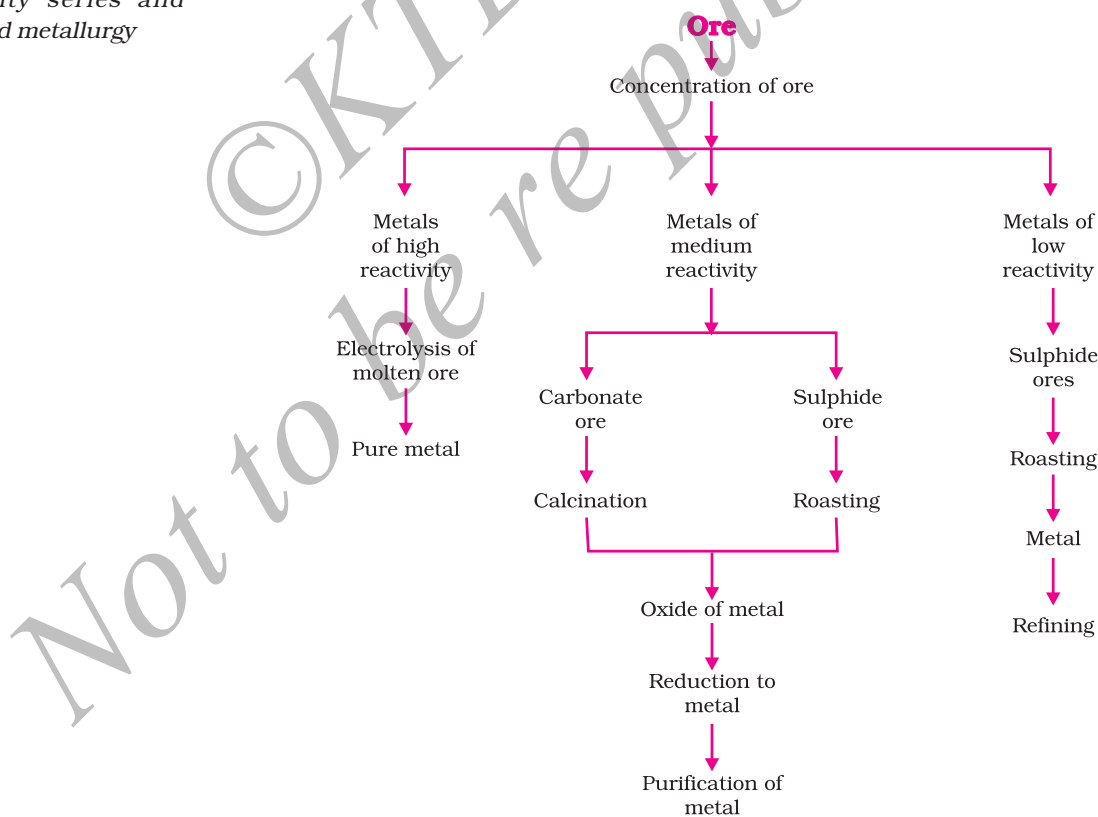

Figure 3.10 Steps involved in the extraction of metals from ores

3.4.2 Enrichment of Ores

Ores mined from the earth are usually contaminated with large amounts of impurities such as soil, sand, etc., called gangue. The impurities must be removed from the ore prior to the extraction of the metal. The processes used for removing the gangue from the ore are based on the differences between the physical or chemical properties of the gangue and the ore. Different separation techniques are accordingly employed.

3.4.3 Extracting Metals Low in the Activity Series

Metals low in the activity series are very unreactive. The oxides of these metals can be reduced to metals by heating alone. For example, cinnabar (HgS) is an ore of mercury. When it is heated in air, it is first converted into mercuric oxide (HgO). Mercuric oxide is then reduced to mercury on further heating.



Similarly, copper which is found as Cu_2S in nature can be obtained from its ore by just heating in air.



3.4.4 Extracting Metals in the Middle of the Activity Series

The metals in the middle of the activity series such as iron, zinc, lead, copper, are moderately reactive. These are usually present as sulphides or carbonates in nature. It is easier to obtain a metal from its oxide, as compared to its sulphides and carbonates. Therefore, prior to reduction, the metal sulphides and carbonates must be converted into metal oxides. The sulphide ores are converted into oxides by heating strongly in the presence of excess air. This process is known as roasting. The carbonate ores are changed into oxides by heating strongly in limited air. This process is known as calcination. The chemical reaction that takes place during roasting and calcination of zinc ores can be shown as follows –

Roasting



Calcination

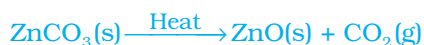

The metal oxides are then reduced to the corresponding metals by using suitable reducing agents such as carbon. For example, when zinc oxide is heated with carbon, it is reduced to metallic zinc.



You are already familiar with the process of oxidation and reduction explained in the first Chapter. Obtaining metals from their compounds is also a reduction process.

Besides using carbon (coke) to reduce metal oxides to metals, sometimes displacement reactions can also be used. The highly reactive metals such as sodium, calcium, aluminium, etc., are used as reducing agents because they can displace metals of lower reactivity from their compounds. For example, when manganese dioxide is heated with aluminium powder, the following reaction takes place –



Figure 3.11
Thermit process for joining railway tracks



Can you identify the substances that are getting oxidised and reduced?

These displacement reactions are highly exothermic. The amount of heat evolved is so large that the metals are produced in the molten state. In fact, the reaction of iron(III) oxide (Fe_2O_3) with aluminium is used to join railway tracks or cracked machine parts. This reaction is known as the thermite reaction.



3.4.5 Extracting Metals towards the Top of the Activity Series

The metals high up in the reactivity series are very reactive. They cannot be obtained from their compounds by heating with carbon. For example, carbon cannot reduce the oxides of sodium, magnesium, calcium, aluminium, etc., to the respective metals. This is because these metals have more affinity for oxygen than carbon. These metals are obtained by electrolytic reduction. For example, sodium, magnesium and calcium are obtained by the electrolysis of their molten chlorides. The metals are deposited at the cathode (the negatively charged electrode), whereas, chlorine is liberated at the anode (the positively charged electrode). The reactions are –



Similarly, aluminium is obtained by the electrolytic reduction of aluminium oxide.

3.4.6 Refining of Metals

The metals produced by various reduction processes described above are not very pure. They contain impurities, which must be removed to obtain pure metals. The most widely used method for refining impure metals is electrolytic refining.

Electrolytic Refining: Many metals, such as copper, zinc, tin, nickel, silver, gold, etc., are refined electrolytically. In this process, the impure metal is made the anode and a thin strip of pure metal is made the cathode. A solution of the metal salt is used as an electrolyte. The apparatus is set up as shown in Fig. 3.12. On passing the current through the electrolyte, the pure metal from the anode dissolves into the electrolyte. An equivalent amount of pure metal from the electrolyte is deposited on the cathode. The soluble impurities go into the solution, whereas, the insoluble impurities settle down at the bottom of the anode and are known as anode mud.

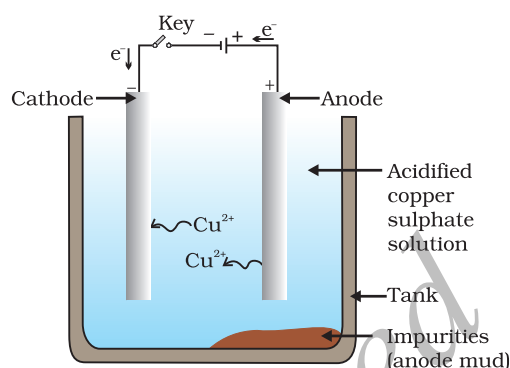

Figure 3.12
Electrolytic refining of copper. The electrolyte is a solution of acidified copper sulphate. The anode is impure copper, whereas, the cathode is a strip of pure copper. On passing electric current, pure copper is deposited on the cathode.

Q U E S T I O N S

1. Define the following terms.
(i) Mineral (ii) Ore (iii) Gangue
2. Name two metals which are found in nature in the free state.
3. What chemical process is used for obtaining a metal from its oxide?

3.5 CORROSION

You have learnt the following about corrosion in Chapter 1 –

- Silver articles become black after some time when exposed to air. This is because it reacts with sulphur in the air to form a coating of silver sulphide.
- Copper reacts with moist carbon dioxide in the air and slowly loses its shiny brown surface and gains a green coat. This green substance is basic copper carbonate.
- Iron when exposed to moist air for a long time acquires a coating of a brown flaky substance called rust.

Let us find out the conditions under which iron rusts.

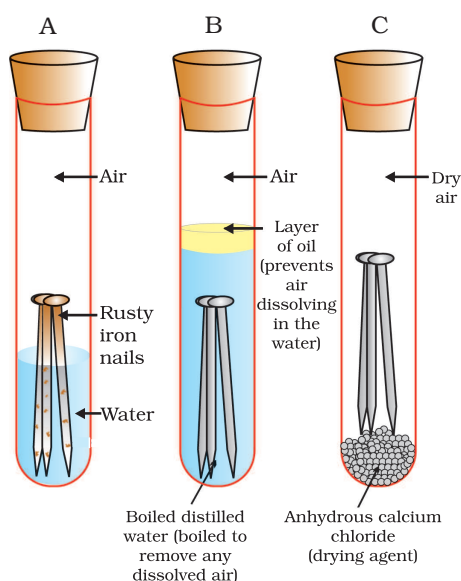

Figure 3.13
Investigating the conditions under which iron rusts. In tube A, both air and water are present. In tube B, there is no air dissolved in the water. In tube C, the air is dry.

Activity 3.14

- Take three test tubes and place clean iron nails in each of them.
- Label these test tubes A, B and C. Pour some water in test tube A and cork it.
- Pour boiled distilled water in test tube B, add about 1 mL of oil and cork it. The oil will float on water and prevent the air from dissolving in the water.
- Put some anhydrous calcium chloride in test tube C and cork it. Anhydrous calcium chloride will absorb the moisture, if any, from the air. Leave these test tubes for a few days and then observe (Fig. 3.13).

You will observe that iron nails rust in test tube A, but they do not rust in test tubes B and C. In the test tube A, the nails are exposed to both air and water. In the test tube B, the nails are exposed to only water, and the nails in test tube C are exposed to dry air. What does this tell us about the conditions under which iron articles rust?

3.5.1 Prevention of Corrosion

The rusting of iron can be prevented by painting, oiling, greasing, galvanising, chrome plating, anodising or making alloys.

Galvanisation is a method of protecting steel and iron from rusting by coating them with a thin layer of zinc. The galvanised article is protected against rusting even if the zinc coating is broken. Can you reason this out?

Alloying is a very good method of improving the properties of a metal. We can get the desired properties by this method. For example, iron is the most widely used metal. But it is never used in its pure state. This is because pure iron is very soft and stretches easily when hot. But, if it is mixed with a small amount of carbon (about 0.05 %), it becomes hard and strong. When iron is mixed with nickel and chromium, we get stainless steel, which is hard and does not rust. Thus, if iron is mixed with some other substance, its properties change. In fact, the properties of any metal can be changed if it is mixed with some other substance. The substance added may be a metal or a non-metal. An alloy is a homogeneous mixture of two or more metals, or a metal and a non-metal. It is prepared by first melting the primary metal, and then, dissolving the other elements in it in definite proportions. It is then cooled to room temperature.

Do You Know?

Pure gold, known as 24 carat gold, is very soft. It is, therefore, not suitable for making jewellery. It is alloyed with either silver or copper to make it hard. Generally, in India, 22 carat gold is used for making ornaments. It means that 22 parts of pure gold is alloyed with 2 parts of either copper or silver.

If one of the metals is mercury, then the alloy is known as an amalgam. The electrical conductivity and melting point of an alloy is less than that of pure metals. For example, brass, an alloy of copper and zinc (Cu and Zn), and bronze, an alloy of copper and tin (Cu and Sn), are not good conductors of electricity whereas copper is used for making electrical circuits. Solder, an alloy of lead and tin (Pb and Sn), has a low melting point and is used for welding electrical wires together.

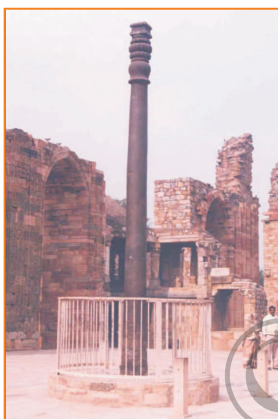

Iron pillar at Delhi

More to Know!

The wonder of ancient Indian metallurgy

The iron pillar near the Qutub Minar in Delhi was built more than 1600 years ago by the iron workers of India. They had developed a process which prevented iron from rusting. For its quality of rust resistance it has been examined by scientists from all parts of the world. The iron pillar is 8 m high and weighs 6 tonnes (6000 kg).

Q U E S T I O N S

1. Metallic oxides of zinc, magnesium and copper were heated with the following metals.

Metal	Zinc	Magnesium	Copper
Zinc oxide			
Magnesium oxide			
Copper oxide			

In which cases will you find displacement reactions taking place?

2. Which metals do not corrode easily?
3. What are alloys?

What you have learnt

- Elements can be classified as metals and non-metals.
- Metals are lustrous, malleable, ductile and are good conductors of heat and electricity. They are solids at room temperature, except mercury which is a liquid.
- Metals can form positive ions by losing electrons to non-metals.
- Metals combine with oxygen to form basic oxides. Aluminium oxide and zinc oxide show the properties of both basic as well as acidic oxides. These oxides are known as amphoteric oxides.
- Different metals have different reactivities with water and dilute acids.
- A list of common metals arranged in order of their decreasing reactivity is known as an activity series.
- Metals above hydrogen in the Activity series can displace hydrogen from dilute acids.
- A more reactive metal displaces a less reactive metal from its salt solution.
- Metals occur in nature as free elements or in the form of their compounds.
- The extraction of metals from their ores and then refining them for use is known as metallurgy.
- An alloy is a homogeneous mixture of two or more metals, or a metal and a non-metal.
- The surface of some metals, such as iron, is corroded when they are exposed to moist air for a long period of time. This phenomenon is known as corrosion.
- Non-metals have properties opposite to that of metals. They are neither malleable nor ductile. They are bad conductors of heat and electricity, except for graphite, which conducts electricity.
- Non-metals form negatively charged ions by gaining electrons when reacting with metals.
- Non-metals form oxides which are either acidic or neutral.
- Non-metals do not displace hydrogen from dilute acids. They react with hydrogen to form hydrides.

EXERCISES

1. Which of the following pairs will give displacement reactions?
 - (a) NaCl solution and copper metal
 - (b) MgCl_2 solution and aluminium metal
 - (c) FeSO_4 solution and silver metal
 - (d) AgNO_3 solution and copper metal.

2. Which of the following methods is suitable for preventing an iron frying pan from rusting?
 - (a) Applying grease
 - (b) Applying paint
 - (c) Applying a coating of zinc
 - (d) All of the above.
3. An element reacts with oxygen to give a compound with a high melting point. This compound is also soluble in water. The element is likely to be
 - (a) calcium
 - (b) carbon
 - (c) silicon
 - (d) iron.
4. Food cans are coated with tin and not with zinc because
 - (a) zinc is costlier than tin.
 - (b) zinc has a higher melting point than tin.
 - (c) zinc is more reactive than tin.
 - (d) zinc is less reactive than tin.
5. You are given a hammer, a battery, a bulb, wires and a switch.
 - (a) How could you use them to distinguish between samples of metals and non-metals?
 - (b) Assess the usefulness of these tests in distinguishing between metals and non-metals.
6. What are amphoteric oxides? Give two examples of amphoteric oxides.
7. Name two metals which will displace hydrogen from dilute acids, and two metals which will not.
8. In the electrolytic refining of a metal M, what would you take as the anode, the cathode and the electrolyte?
9. Pratyush took sulphur powder on a spatula and heated it. He collected the gas evolved by inverting a test tube over it, as shown in figure below.
 - (a) What will be the action of gas on
 - (i) dry litmus paper?
 - (ii) moist litmus paper?
 - (b) Write a balanced chemical equation for the reaction taking place.
10. State two ways to prevent the rusting of iron.

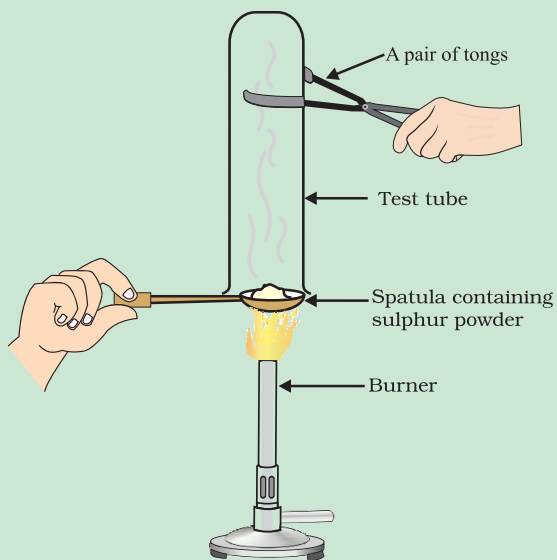

Collection of gas

11. What type of oxides are formed when non-metals combine with oxygen?
12. Give reasons
 - (a) Platinum, gold and silver are used to make jewellery.
 - (b) Sodium, potassium and lithium are stored under oil.
 - (c) Aluminium is a highly reactive metal, yet it is used to make utensils for cooking.
 - (d) Carbonate and sulphide ores are usually converted into oxides during the process of extraction.
13. You must have seen tarnished copper vessels being cleaned with lemon or tamarind juice. Explain why these sour substances are effective in cleaning the vessels.
14. Differentiate between metal and non-metal on the basis of their chemical properties.
15. A man went door to door posing as a goldsmith. He promised to bring back the glitter of old and dull gold ornaments. An unsuspecting lady gave a set of gold bangles to him which he dipped in a particular solution. The bangles sparkled like new but their weight was reduced drastically. The lady was upset but after a futile argument the man beat a hasty retreat. Can you play the detective to find out the nature of the solution he had used?
16. Give reasons why copper is used to make hot water tanks and not steel (an alloy of iron).

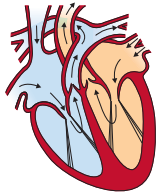

CHAPTER 6

Life Processes



How do we tell the difference between what is alive and what is not alive? If we see a dog running, or a cow chewing cud, or a man shouting loudly on the street, we know that these are living beings. What if the dog or the cow or the man were asleep? We would still think that they were alive, but how did we know that? We see them breathing, and we know that they are alive. What about plants? How do we know that they are alive? We see them green, some of us will say. But what about plants that have leaves of colours other than green? They grow over time, so we know that they are alive, some will say. In other words, we tend to think of some sort of movement, either growth-related or not, as common evidence for being alive. But a plant that is not visibly growing is still alive, and some animals can breathe without visible movement. So using visible movement as the defining characteristic of life is not enough.

Movements over very small scales will be invisible to the naked eye – movements of molecules, for example. Is this invisible molecular movement necessary for life? If we ask this question to professional biologists, they will say yes. In fact, viruses do not show any molecular movement in them (until they infect some cell), and that is partly why there is a controversy about whether they are truly alive or not.

Why are molecular movements needed for life? We have seen in earlier classes that living organisms are well-organised structures; they can have tissues, tissues have cells, cells have smaller components in them, and so on. Because of the effects of the environment, this organised, ordered nature of living structures is very likely to keep breaking down over time. If order breaks down, the organism will no longer be alive. So living creatures must keep repairing and maintaining their structures. Since all these structures are made up of molecules, they must move molecules around all the time.

What are the maintenance processes in living organisms? Let us explore.

6.1 WHAT ARE LIFE PROCESSES?

The maintenance functions of living organisms must go on even when they are not doing anything particular. Even when we are just sitting in

class, even if we are just asleep, this maintenance job has to go on. The processes which together perform this maintenance job are life processes.

Since these maintenance processes are needed to prevent damage and break-down, energy is needed for them. This energy comes from outside the body of the individual organism. So there must be a process to transfer a source of energy from outside the body of the organism, which we call food, to the inside, a process we commonly call nutrition. If the body size of the organisms is to grow, additional raw material will also be needed from outside. Since life on earth depends on carbon-based molecules, most of these food sources are also carbon-based. Depending on the complexity of these carbon sources, different organisms can then use different kinds of nutritional processes.

The outside sources of energy could be quite varied, since the environment is not under the control of the individual organism. These sources of energy, therefore, need to be broken down or built up in the body, and must be finally converted to a uniform source of energy that can be used for the various molecular movements needed for maintaining living structures, as well as to the kind of molecules the body needs to grow. For this, a series of chemical reactions in the body are necessary. Oxidising-reducing reactions are some of the most common chemical means to break-down molecules. For this, many organisms use oxygen sourced from outside the body. The process of acquiring oxygen from outside the body, and to use it in the process of break-down of food sources for cellular needs, is what we call respiration.

In the case of a single-celled organism, no specific organs for taking in food, exchange of gases or removal of wastes may be needed because the entire surface of the organism is in contact with the environment. But what happens when the body size of the organism increases and the body design becomes more complex? In multi-cellular organisms, all the cells may not be in direct contact with the surrounding environment. Thus, simple diffusion will not meet the requirements of all the cells.

We have seen previously how, in multi-cellular organisms, various body parts have specialised in the functions they perform. We are familiar with the idea of these specialised tissues, and with their organisation in the body of the organism. It is therefore not surprising that the uptake of food and of oxygen will also be the function of specialised tissues. However, this poses a problem, since the food and oxygen are now taken up at one place in the body of the organisms, while all parts of the body need them. This situation creates a need for a transportation system for carrying food and oxygen from one place to another in the body.

When chemical reactions use the carbon source and the oxygen for energy generation, they create by-products that are not only useless for the cells of the body, but could even be harmful. These waste by-products are therefore needed to be removed from the body and discarded outside by a process called excretion. Again, if the basic rules for body

design in multi-cellular organisms are followed, a specialised tissue for excretion will be developed, which means that the transportation system will need to transport waste away from cells to this excretory tissue.

Let us consider these various processes, so essential to maintain life, one by one.

Q U E S T I O N S

1. Why is diffusion insufficient to meet the oxygen requirements of multi-cellular organisms like humans?
2. What criteria do we use to decide whether something is alive?
3. What are outside raw materials used for by an organism?
4. What processes would you consider essential for maintaining life?

6.2 NUTRITION

When we walk or ride a bicycle, we are using up energy. Even when we are not doing any apparent activity, energy is needed to maintain a state of order in our body. We also need materials from outside in order to grow, develop, synthesise protein and other substances needed in the body. This source of energy and materials is the food we eat.

How do living things get their food?

The general requirement for energy and materials is common in all organisms, but it is fulfilled in different ways. Some organisms use simple food material obtained from inorganic sources in the form of carbon dioxide and water. These organisms, the autotrophs, include green plants and some bacteria. Other organisms utilise complex substances. These complex substances have to be broken down into simpler ones before they can be used for the upkeep and growth of the body. To achieve this, organisms use bio-catalysts called enzymes. Thus, the heterotrophs survival depends directly or indirectly on autotrophs. Heterotrophic organisms include animals and fungi.

6.2.1 Autotrophic Nutrition

Carbon and energy requirements of the autotrophic organism are fulfilled by photosynthesis. It is the process by which autotrophs take in substances from the outside and convert them into stored forms of energy. This material is taken in the form of carbon dioxide and water which is converted into carbohydrates in the presence of sunlight and chlorophyll. Carbohydrates are utilised for providing energy to the plant. We will study how this takes place in the next section. The carbohydrates which are not used immediately are stored in the form of starch, which serves as the internal energy reserve to be used as and when required by the plant. A somewhat similar situation is seen in us where some of the energy derived from the food we eat is stored in our body in the form of glycogen.



Let us now see what actually happens during the process of photosynthesis. The following events occur during this process –

- (i) Absorption of light energy by chlorophyll.
- (ii) Conversion of light energy to chemical energy and splitting of water molecules into hydrogen and oxygen.
- (iii) Reduction of carbon dioxide to carbohydrates.

These steps need not take place one after the other immediately. For example, desert plants take up carbon dioxide at night and prepare an intermediate which is acted upon by the energy absorbed by the chlorophyll during the day.

Let us see how each of the components of the above reaction are necessary for photosynthesis.

If you carefully observe a cross-section of a leaf under the microscope (shown in Fig. 6.1), you will notice that some cells contain green dots. These green dots are cell organelles called chloroplasts which contain chlorophyll. Let us do an activity which demonstrates that chlorophyll is essential for photosynthesis.

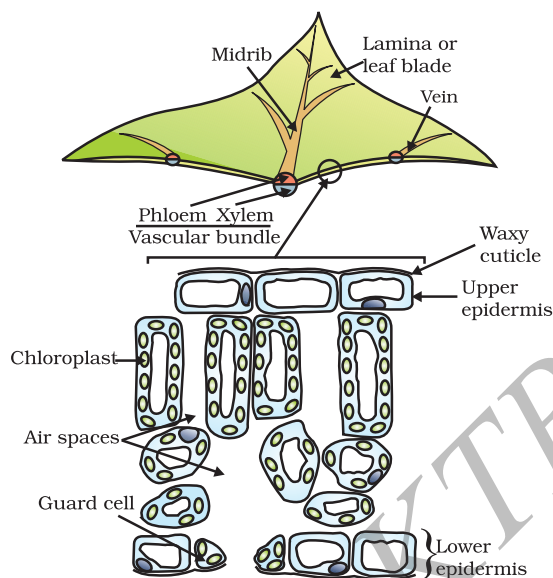

Figure 6.1
Cross-section of a leaf

Activity 6.1

- Take a potted plant with variegated leaves – for example, money plant or crotons.
- Keep the plant in a dark room for three days so that all the starch gets used up.
- Now keep the plant in sunlight for about six hours.
- Pluck a leaf from the plant. Mark the green areas in it and trace them on a sheet of paper.
- Dip the leaf in boiling water for a few minutes.
- After this, immerse it in a beaker containing alcohol.
- Carefully place the above beaker in a water-bath and heat till the alcohol begins to boil.
- What happens to the colour of the leaf? What is the colour of the solution?
- Now dip the leaf in a dilute solution of iodine for a few minutes.
- Take out the leaf and rinse off the iodine solution.
- Observe the colour of the leaf and compare this with the tracing of the leaf done in the beginning (Fig. 6.2).
- What can you conclude about the presence of starch in various areas of the leaf?

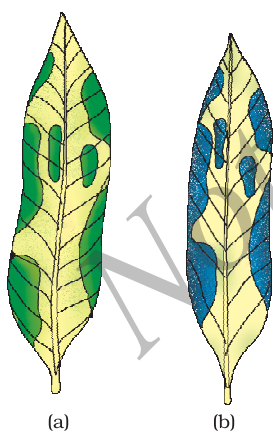

Figure 6.2
Variegated leaf (a) before and (b) after starch test

Now, let us study how the plant obtains carbon dioxide. In Class IX, we had talked about stomata (Fig. 6.3) which are tiny pores present on the surface of the leaves. Massive amounts of gaseous exchange takes place in the leaves through these pores for the purpose of photosynthesis. But it is important to note here that exchange of gases occurs across the surface of stems, roots and leaves as well. Since large amounts of water can also be lost through these stomata, the plant closes these pores when it does not need carbon dioxide for photosynthesis. The opening and closing of the pore is a function of the guard cells. The guard cells swell when water flows into them, causing the stomatal pore to open. Similarly the pore closes if the guard cells shrink.

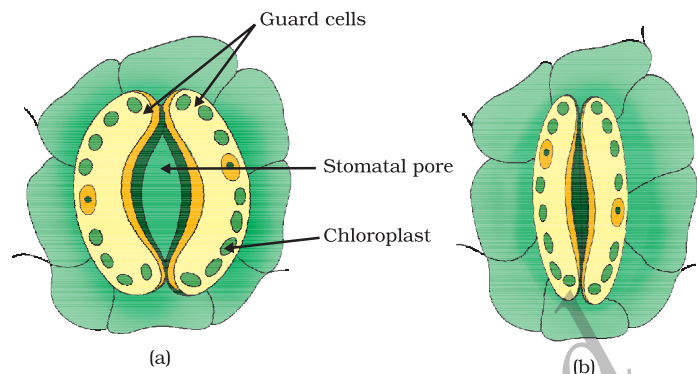

Figure 6.3 (a) Open and (b) closed stomatal pore

Activity 6.2

- Take two healthy potted plants which are nearly the same size.
- Keep them in a dark room for three days.
- Now place each plant on separate glass plates. Place a watch-glass containing potassium hydroxide by the side of one of the plants. The potassium hydroxide is used to absorb carbon dioxide.
- Cover both plants with separate bell-jars as shown in Fig. 6.4.
- Use vaseline to seal the bottom of the jars to the glass plates so that the set-up is air-tight.
- Keep the plants in sunlight for about two hours.
- Pluck a leaf from each plant and check for the presence of starch as in the above activity.
- Do both the leaves show the presence of the same amount of starch?
- What can you conclude from this activity?

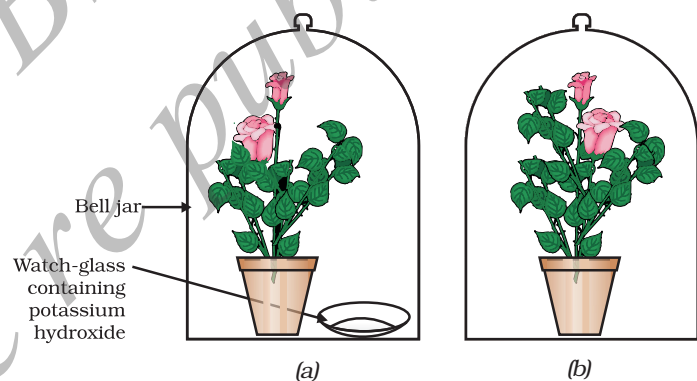

Figure 6.4 Experimental set-up (a) with potassium hydroxide (b) without potassium hydroxide

Based on the two activities performed above, can we design an experiment to demonstrate that sunlight is essential for photosynthesis?

So far, we have talked about how autotrophs meet their energy requirements. But they also need other raw materials for building their body. Water used in photosynthesis is taken up from the soil by the roots in terrestrial plants. Other materials like nitrogen, phosphorus, iron and magnesium are taken up from the soil. Nitrogen is an essential element used in the synthesis of proteins and other compounds. This is

taken up in the form of inorganic nitrates or nitrites. Or it is taken up as organic compounds which have been prepared by bacteria from atmospheric nitrogen.

6.2.2 Heterotrophic Nutrition

Each organism is adapted to its environment. The form of nutrition differs depending on the type and availability of food material as well as how it is obtained by the organism. For example, whether the food source is stationary (such as grass) or mobile (such as a deer), would allow for differences in how the food is accessed and what is the nutritive apparatus used by a cow and a lion. There is a range of strategies by which the food is taken in and used by the organism. Some organisms break-down the food material outside the body and then absorb it. Examples are fungi like bread moulds, yeast and mushrooms. Others take in whole material and break it down inside their bodies. What can be taken in and broken down depends on the body design and functioning. Some other organisms derive nutrition from plants or animals without killing them. This parasitic nutritive strategy is used by a wide variety of organisms like cuscuta (amar-bel), ticks, lice, leeches and tape-worms.

6.2.3 How do Organisms obtain their Nutrition?

Since the food and the way it is obtained differ, the digestive system is different in various organisms. In single-celled organisms, the food may be taken in by the entire surface. But as the complexity of the organism increases, different parts become specialised to perform different functions. For example, *Amoeba* takes in food using temporary finger-like extensions of the cell surface which fuse over the food particle forming a food-vacuole (Fig. 6.5). Inside the food-vacuole, complex substances are broken down into simpler ones which then diffuse into the cytoplasm. The remaining undigested material is moved to the surface of the cell and thrown out. In *Paramecium*, which is also a unicellular organism, the cell has a definite shape and food is taken in at a specific spot. Food is moved to this spot by the movement of cilia which cover the entire surface of the cell.

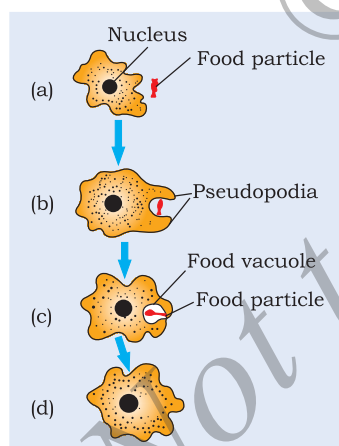

Figure 6.5
Nutrition in *Amoeba*

6.2.4 Nutrition in Human Beings

The alimentary canal is basically a long tube extending from the mouth to the anus. In Fig. 6.6, we can see that the tube has different parts. Various regions are specialised to perform different functions. What happens to the food once it enters our body? We shall discuss this process here.

Activity 6.3

- Take 1 mL starch solution (1%) in two test tubes (A and B).
- Add 1 mL saliva to test tube A and leave both test tubes undisturbed for 20-30 minutes.
- Now add a few drops of dilute iodine solution to the test tubes.
- In which test tube do you observe a colour change?
- What does this indicate about the presence or absence of starch in the two test tubes?
- What does this tell us about the action of saliva on starch?

We eat various types of food which has to pass through the same digestive tract. Naturally the food has to be processed to generate particles which are small and of the same texture. This is achieved by crushing the food with our teeth. Since the lining of the canal is soft, the food is also wetted to make its passage smooth. When we eat something we like, our mouth 'waters'. This is actually not only water, but a fluid called saliva secreted by the salivary glands. Another aspect of the food we ingest is its complex nature. If it is to be absorbed from the alimentary canal, it has to be broken into smaller molecules. This is done with the help of biological catalysts called enzymes. The saliva contains an enzyme called salivary amylase that breaks down starch which is a complex molecule to give simple sugar. The food is mixed thoroughly with saliva and moved around the mouth while chewing by the muscular tongue.

It is necessary to move the food in a regulated manner along the digestive tube so that it can be processed properly in each part. The lining of canal has muscles that contract rhythmically in order to push the food forward. These peristaltic movements occur all along the gut.

From the mouth, the food is taken to the stomach through the food-pipe or oesophagus. The stomach is a large organ which expands when food enters it. The muscular walls of the stomach help in mixing the food thoroughly with more digestive juices.

The digestion in stomach is taken care of by the gastric glands present in the wall of the stomach. These release hydrochloric acid, a protein digesting enzyme called pepsin, and mucus. The hydrochloric acid creates an acidic medium which facilitates the action of the enzyme pepsin. What other function do you think is served by the acid? The mucus protects the inner lining of the stomach from the action of the acid under normal conditions. We

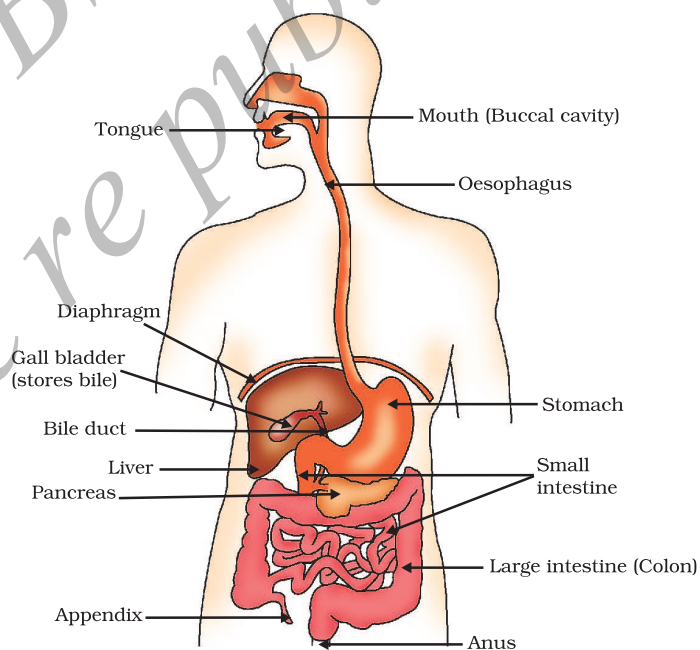

Figure 6.6 Human alimentary canal

have often heard adults complaining about 'acidity'. Can this be related to what has been discussed above?

The exit of food from the stomach is regulated by a sphincter muscle which releases it in small amounts into the small intestine. From the stomach, the food now enters the small intestine. This is the longest part of the alimentary canal which is fitted into a compact space because of extensive coiling. The length of the small intestine differs in various animals depending on the food they eat. Herbivores eating grass need a longer small intestine to allow the cellulose to be digested. Meat is easier to digest, hence carnivores like tigers have a shorter small intestine.

The small intestine is the site of the complete digestion of carbohydrates, proteins and fats. It receives the secretions of the liver and pancreas for this purpose. The food coming from the stomach is acidic and has to be made alkaline for the pancreatic enzymes to act. Bile juice from the liver accomplishes this in addition to acting on fats. Fats are present in the intestine in the form of large globules which makes it difficult for enzymes to act on them. Bile salts break them down into smaller globules increasing the efficiency of enzyme action. This is similar to the emulsifying action of soaps on dirt that we have learnt about in Chapter 4. The pancreas secretes pancreatic juice which contains enzymes like trypsin for digesting proteins and lipase for breaking down emulsified fats. The walls of the small intestine contain glands which secrete intestinal juice. The enzymes present in it finally convert the proteins to amino acids, complex carbohydrates into glucose and fats into fatty acids and glycerol.

Digested food is taken up by the walls of the intestine. The inner lining of the small intestine has numerous finger-like projections called villi which increase the surface area for absorption. The villi are richly supplied with blood vessels which take the absorbed food to each and every cell of the body, where it is utilised for obtaining energy, building up new tissues and the repair of old tissues.

The unabsorbed food is sent into the large intestine where its wall absorb more water from this material. The rest of the material is removed from the body via the anus. The exit of this waste material is regulated by the anal sphincter.

Dental caries

Dental caries or tooth decay causes gradual softening of enamel and dentine. It begins when bacteria acting on sugars produce acids that softens or demineralises the enamel. Masses of bacterial cells together with food particles stick to the teeth to form dental plaque. Saliva cannot reach the tooth surface to neutralise the acid as plaque covers the teeth. Brushing the teeth after eating removes the plaque before the bacteria produce acids. If untreated, microorganisms may invade the pulp, causing inflammation and infection.

Q U E S T I O N S

1. What are the differences between autotrophic nutrition and heterotrophic nutrition?
2. Where do plants get each of the raw materials required for photosynthesis?
3. What is the role of the acid in our stomach?
4. What is the function of digestive enzymes?
5. How is the small intestine designed to absorb digested food?

6.3 RESPIRATION

Activity 6.4

- Take some freshly prepared lime water in a test tube.
- Blow air through this lime water.
- Note how long it takes for the lime water to turn milky.
- Use a syringe or *pichkari* to pass air through some fresh lime water taken in another test tube (Fig. 6.7).
- Note how long it takes for this lime water to turn milky.
- What does this tell us about the amount of carbon dioxide in the air that we breathe out?

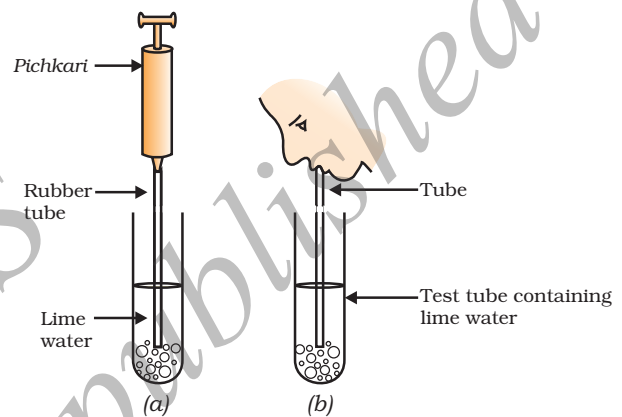

Figure 6.7
(a) Air being passed into lime water with a pichkari/
syringe, (b) air being exhaled into lime water

Activity 6.5

- Take some fruit juice or sugar solution and add some yeast to this. Take this mixture in a test tube fitted with a one-holed cork.
- Fit the cork with a bent glass tube. Dip the free end of the glass tube into a test tube containing freshly prepared lime water.
- What change is observed in the lime water and how long does it take for this change to occur?
- What does this tell us about the products of fermentation?

We have discussed nutrition in organisms in the last section. The food material taken in during the process of nutrition is used in cells to provide energy for various life processes. Diverse organisms do this in different ways – some use oxygen to break-down glucose completely into carbon dioxide and water, some use other pathways that do not involve oxygen (Fig. 6.8). In all cases, the first step is the break-down of glucose, a six-carbon molecule, into a three-carbon molecule called pyruvate. This process takes place in the cytoplasm. Further, the pyruvate may be converted into ethanol and carbon dioxide. This process takes place in yeast during fermentation. Since this process takes place in the absence of air (oxygen), it is called anaerobic respiration. Break-down of pyruvate using oxygen takes place in the mitochondria. This

process breaks up the three-carbon pyruvate molecule to give three molecules of carbon dioxide. The other product is water. Since this process takes place in the presence of air (oxygen), it is called aerobic respiration. The release of energy in this aerobic process is a lot greater than in the anaerobic process. Sometimes, when there is a lack of oxygen in our muscle cells, another pathway for the break-down of pyruvate is taken. Here the pyruvate is converted into lactic acid which is also a three-carbon molecule. This build-up of lactic acid in our muscles during sudden activity causes cramps.

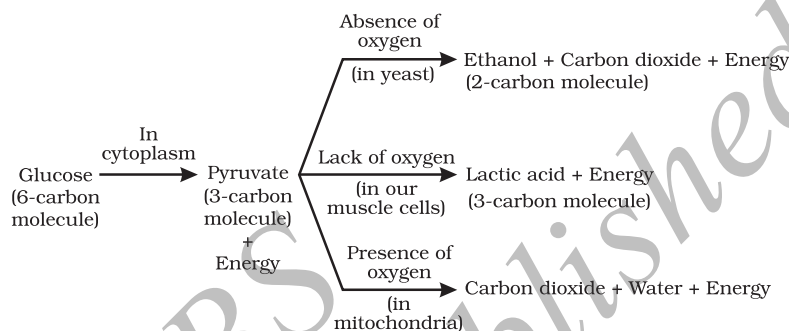

Figure 6.8 Break-down of glucose by various pathways

The energy released during cellular respiration is immediately used to synthesise a molecule called ATP which is used to fuel all other activities in the cell. In these processes, ATP is broken down giving rise to a fixed amount of energy which can drive the endothermic reactions taking place in the cell.

More to Know!

ATP

ATP is the energy currency for most cellular processes. The energy released during the process of respiration is used to make an ATP molecule from ADP and inorganic phosphate.

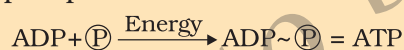

Ⓟ: Phosphate

Endothermic processes in the cell then use this ATP to drive the reactions. When the terminal phosphate linkage in ATP is broken using water, the energy equivalent to 30.5 kJ/mol is released.

Think of how a battery can provide energy for many different kinds of uses. It can be used to obtain mechanical energy, light energy, electrical energy and so on. Similarly, ATP can be used in the cells for the contraction of muscles, protein synthesis, conduction of nervous impulses and many other activities.

Since the aerobic respiration pathway depends on oxygen, aerobic organisms need to ensure that there is sufficient intake of oxygen. We have seen that plants exchange gases through stomata, and the large inter-cellular spaces ensure that all cells are in contact with air. Carbon dioxide and oxygen are exchanged by diffusion here. They can go into

cells, or away from them and out into the air. The direction of diffusion depends upon the environmental conditions and the requirements of the plant. At night, when there is no photosynthesis occurring, CO₂ elimination is the major exchange activity going on. During the day, CO₂ generated during respiration is used up for photosynthesis, hence there is no CO₂ release. Instead, oxygen release is the major event at this time.

Animals have evolved different organs for the uptake of oxygen from the environment and for getting rid of the carbon dioxide produced. Terrestrial animals can breathe the oxygen in the atmosphere, but animals that live in water need to use the oxygen dissolved in water.

Activity 6.6

- Observe fish in an aquarium. They open and close their mouths and the gill-slits (or the operculum which covers the gill-slits) behind their eyes also open and close. Are the timings of the opening and closing of the mouth and gill-slits coordinated in some manner?
- Count the number of times the fish opens and closes its mouth in a minute.
- Compare this to the number of times you breathe in and out in a minute.

Since the amount of dissolved oxygen is fairly low compared to the amount of oxygen in the air, the rate of breathing in aquatic organisms is much faster than that seen in terrestrial organisms. Fishes take in water through their mouths and force it past the gills where the dissolved oxygen is taken up by blood.

Terrestrial organisms use the oxygen in the atmosphere for respiration. This oxygen is absorbed by different organs in different animals. All these organs have a structure that increases the surface area which is in contact with the oxygen-rich atmosphere. Since the exchange of oxygen and carbon dioxide has to take place across this surface, this surface is very fine and delicate. In order to protect this surface, it is usually placed within the body, so there have to be passages that will take air to this area. In addition, there is a mechanism for moving the air in and out of this area where the oxygen is absorbed.

In human beings (Fig. 6.9), air is taken into the body through the nostrils. The air passing through the nostrils is filtered by fine hairs that line the passage. The passage is also lined with mucus which helps in this process. From here, the air passes through the throat and into the lungs. Rings of cartilage are present in the throat. These ensure that the air-passage does not collapse.

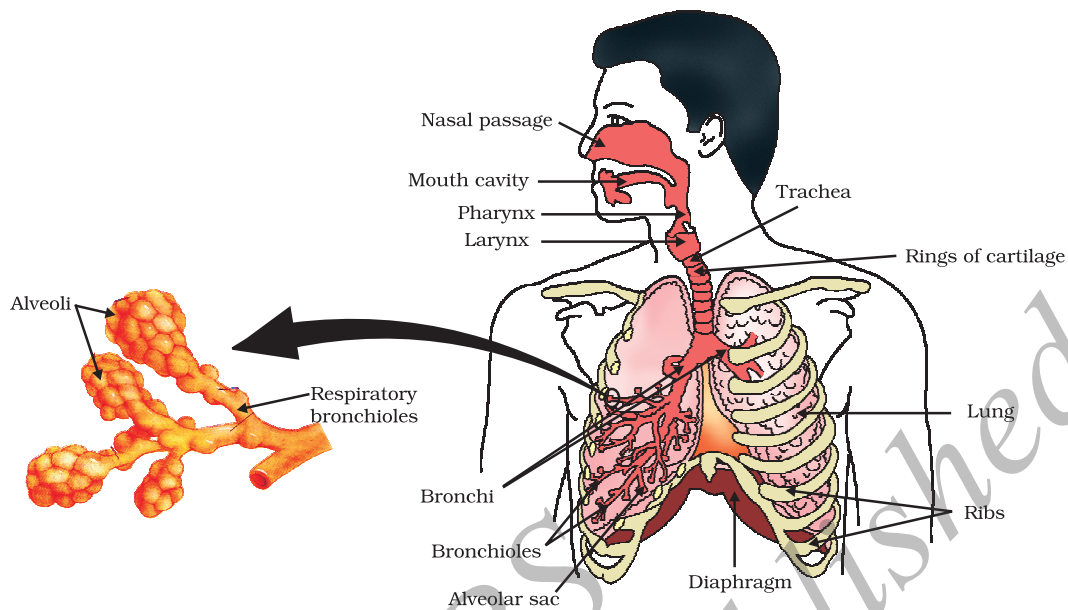

Figure 6.9 Human respiratory system

Do You Know?

Smoking is injurious to health.

Lung cancer is one of common causes of deaths in the world. The upper part of respiratory tract is provided with small hair-like structures called cilia. These cilia help to remove germs, dust and other harmful particles from inhaled air. Smoking destroys these hair due to which germs, dust, smoke and other harmful chemicals enter lungs and cause infection, cough and even lung cancer.

Within the lungs, the passage divides into smaller and smaller tubes which finally terminate in balloon-like structures which are called alveoli (singular–alveolus). The alveoli provide a surface where the exchange of gases can take place. The walls of the alveoli contain an extensive network of blood-vessels. As we have seen in earlier years, when we breathe in, we lift our ribs and flatten our diaphragm, and the chest cavity becomes larger as a result. Because of this, air is sucked into the lungs and fills the expanded alveoli. The blood brings carbon dioxide from the rest of the body for release into the alveoli, and the oxygen in the alveolar air is taken up by blood in the alveolar blood vessels to be transported to all the cells in the body. During the breathing cycle, when air is taken in and let out, the lungs always contain a residual volume of air so that there is sufficient time for oxygen to be absorbed and for the carbon dioxide to be released.

When the body size of animals is large, the diffusion pressure alone cannot take care of oxygen delivery to all parts of the body. Instead, respiratory pigments take up oxygen from the air in the lungs and carry it to tissues which are deficient in oxygen before releasing it. In human beings, the respiratory pigment is haemoglobin which has a very high affinity for oxygen. This pigment is present in the red blood corpuscles. Carbon dioxide is more soluble in water than oxygen is and hence is mostly transported in the dissolved form in our blood.

Do You Know?

- If the alveolar surface were spread out, it would cover about 80 m². How much do you think the surface area of your body is? Consider how efficient exchange of gases becomes because of the large surface available for the exchange to take place.
- If diffusion were to move oxygen in our body, it is estimated that it would take 3 years for a molecule of oxygen to get to our toes from our lungs. Aren't you glad that we have haemoglobin?

Q U E S T I O N S

1. What advantage over an aquatic organism does a terrestrial organism have with regard to obtaining oxygen for respiration?
2. What are the different ways in which glucose is oxidised to provide energy in various organisms?
3. How is oxygen and carbon dioxide transported in human beings?
4. How are the lungs designed in human beings to maximise the area for exchange of gases?

6.4 TRANSPORTATION

6.4.1 Transportation in Human Beings

Activity 6.7

- Visit a health centre in your locality and find out what is the normal range of haemoglobin content in human beings.
- Is it the same for children and adults?
- Is there any difference in the haemoglobin levels for men and women?
- Visit a veterinary clinic in your locality. Find out what is the normal range of haemoglobin content in an animal like the buffalo or cow.
- Is this content different in calves, male and female animals?
- Compare the difference seen in male and female human beings and animals.
- How would the difference, if any, be explained?

We have seen in previous sections that blood transports food, oxygen and waste materials in our bodies. In Class IX, we learnt about blood being a fluid connective tissue. Blood consists of a fluid medium called plasma in which the cells are suspended. Plasma transports food, carbon dioxide and nitrogenous wastes in dissolved form. Oxygen is carried by the red blood corpuscles. Many other substances like salts, are also transported by the blood. We thus need a pumping organ to push blood around the body, a network of tubes to reach all the tissues and a system in place to ensure that this network can be repaired if damaged.

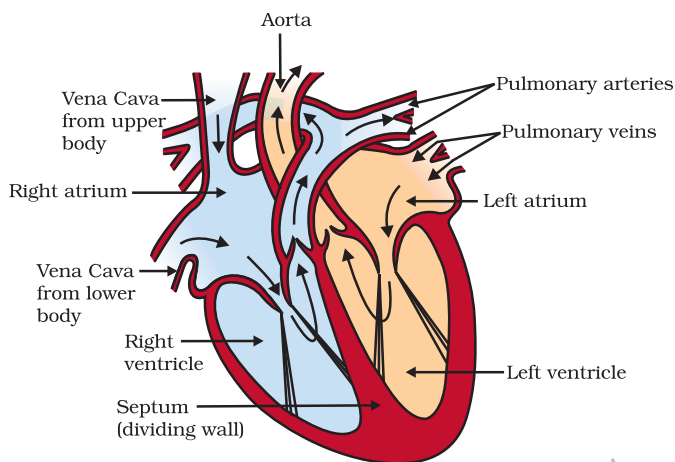

Figure 6.10
Schematic sectional view of the human heart

Our pump — the heart

The heart is a muscular organ which is as big as our fist (Fig. 6.10). Because both oxygen and carbon dioxide have to be transported by the blood, the heart has different chambers to prevent the oxygen-rich blood from mixing with the blood containing carbon dioxide. The carbon dioxide-rich blood has to reach the lungs for the carbon dioxide to be removed, and the oxygenated blood from the lungs has to be brought back to the heart. This oxygen-rich blood is then pumped to the rest of the body.

We can follow this process step by step (Fig. 6.11). Oxygen-rich blood from the lungs comes to the thin-walled upper chamber of the heart on the left, the left atrium. The left atrium relaxes when it is collecting this blood. It then contracts, while the next chamber, the left ventricle, relaxes, so that the blood is transferred to it. When the muscular left ventricle contracts in its turn, the blood is pumped out to the body. De-oxygenated blood comes from the body to the upper chamber on the right, the right atrium, as it relaxes. As the right atrium contracts, the corresponding lower chamber, the right ventricle, dilates. This transfers blood to the right ventricle, which in turn pumps it to the lungs for oxygenation. Since ventricles have to pump blood into various organs, they have thicker muscular walls than the atria do. Valves ensure that blood does not flow backwards when the atria or ventricles contract.

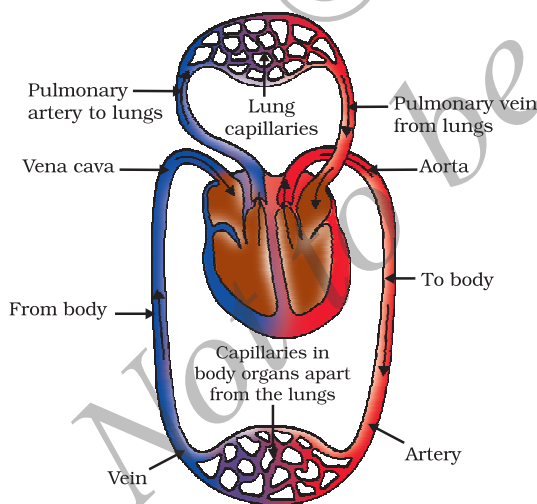

Figure 6.11
Schematic representation of transport and exchange of oxygen and carbon dioxide

Oxygen enters the blood in the lungs

The separation of the right side and the left side of the heart is useful to keep oxygenated and de-oxygenated blood from mixing. Such separation allows a highly efficient supply of oxygen to the body. This is useful in animals that have high energy needs, such as birds and mammals, which constantly use energy to maintain their body temperature. In animals that do not use energy for this purpose, the body temperature depends on the temperature in the environment. Such animals, like amphibians or many reptiles have three-chambered hearts, and tolerate some mixing of the oxygenated and de-oxygenated blood streams. Fishes, on the other hand, have only two chambers to their hearts, and the blood is pumped to the gills, is oxygenated there, and passes directly to the rest of the body. Thus, blood goes only once through the heart in the fish during one cycle of

passage through the body. On the other hand, it goes through the heart twice during each cycle in other vertebrates. This is known as double circulation.

Blood pressure

The force that blood exerts against the wall of a vessel is called blood pressure. This pressure is much greater in arteries than in veins. The pressure of blood inside the artery during ventricular systole (contraction) is called systolic pressure and pressure in artery during ventricular diastole (relaxation) is called diastolic pressure. The normal systolic pressure is about 120 mm of Hg and diastolic pressure is 80 mm of Hg.

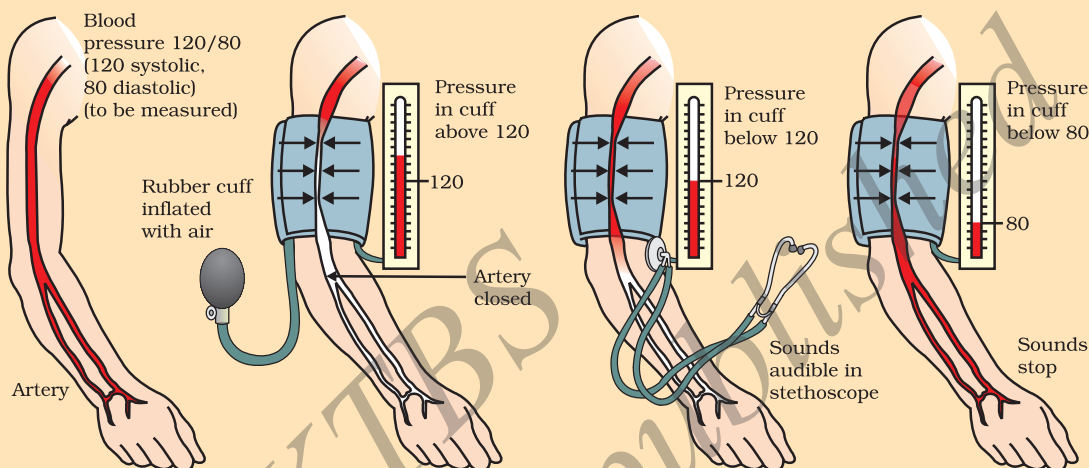

Blood pressure is measured with an instrument called sphygmomanometer. High blood pressure is also called hypertension and is caused by the constriction of arterioles, which results in increased resistance to blood flow. It can lead to the rupture of an artery and internal bleeding.

The tubes – blood vessels

Arteries are the vessels which carry blood away from the heart to various organs of the body. Since the blood emerges from the heart under high pressure, the arteries have thick, elastic walls. Veins collect the blood from different organs and bring it back to the heart. They do not need thick walls because the blood is no longer under pressure, instead they have valves that ensure that the blood flows only in one direction.

On reaching an organ or tissue, the artery divides into smaller and smaller vessels to bring the blood in contact with all the individual cells. The smallest vessels have walls which are one-cell thick and are called capillaries. Exchange of material between the blood and surrounding cells takes place across this thin wall. The capillaries then join together to form veins that convey the blood away from the organ or tissue.

Maintenance by platelets

What happens if this system of tubes develops a leak? Think about situations when we are injured and start bleeding. Naturally the loss of blood from the system has to be minimised. In addition, leakage would lead to a loss of pressure which would reduce the efficiency of the

pumping system. To avoid this, the blood has platelet cells which circulate around the body and plug these leaks by helping to clot the blood at these points of injury.

Lymph

There is another type of fluid also involved in transportation. This is called lymph or tissue fluid. Through the pores present in the walls of capillaries some amount of plasma, proteins and blood cells escape into intercellular spaces in the tissues to form the tissue fluid or lymph. It is similar to the plasma of blood but colourless and contains less protein. Lymph drains into lymphatic capillaries from the intercellular spaces, which join to form large lymph vessels that finally open into larger veins. Lymph carries digested and absorbed fat from intestine and drains excess fluid from extra cellular space back into the blood.

6.4.2 Transportation in Plants

We have discussed earlier how plants take in simple compounds such as CO_2 and photosynthesise energy stored in their chlorophyll-containing organs, namely leaves. The other kinds of raw materials needed for building plant bodies will also have to be taken up separately. For plants, the soil is the nearest and richest source of raw materials like nitrogen, phosphorus and other minerals. The absorption of these substances therefore occurs through the part in contact with the soil, namely roots. If the distances between soil-contacting organs and chlorophyll-containing organs are small, energy and raw materials can easily diffuse to all parts of the plant body. But if these distances become large because of changes in plant body design, diffusion processes will not be sufficient to provide raw material in leaves and energy in roots. A proper system of transportation is therefore essential in such situations.

Energy needs differ between different body designs. Plants do not move, and plant bodies have a large proportion of dead cells in many tissues. As a result, plants have low energy needs, and can use relatively slow transport systems. The distances over which transport systems have to operate, however, can be very large in plants such as very tall trees.

Plant transport systems will move energy stores from leaves and raw materials from roots. These two pathways are constructed as independently organised conducting tubes. One, the xylem moves water and minerals obtained from the soil. The other, phloem transports products of photosynthesis from the leaves where they are synthesised to other parts of the plant. We have studied the structure of these tissues in detail in Class IX.

Transport of water

In xylem tissue, vessels and tracheids of the roots, stems and leaves are interconnected to form a continuous system of water-conducting channels reaching all parts of the plant. At the roots, cells in contact with the soil actively take up ions. This creates a difference in the concentration of these ions between the root and the soil. Water, therefore,

moves into the root from the soil to eliminate this difference. This means that there is steady movement of water into root xylem, creating a column of water that is steadily pushed upwards.

However, this pressure by itself is unlikely to be enough to move water over the heights that we commonly see in plants. Plants use another strategy to move water in the xylem upwards to the highest points of the plant body.

Activity 6.8

- Take two small pots of approximately the same size and having the same amount of soil. One should have a plant in it. Place a stick of the same height as the plant in the other pot.
- Cover the soil in both pots with a plastic sheet so that moisture cannot escape by evaporation.
- Cover both sets, one with the plant and the other with the stick, with plastic sheets and place in bright sunlight for half an hour.
- Do you observe any difference in the two cases?

Provided that the plant has an adequate supply of water, the water which is lost through the stomata is replaced by water from the xylem vessels in the leaf. In fact, evaporation of water molecules from the cells of a leaf creates a suction which pulls water from the xylem cells of roots. The loss of water in the form of vapour from the aerial parts of the plant is known as transpiration.

Thus, transpiration helps in the absorption and upward movement of water and minerals dissolved in it from roots to the leaves. It also helps in temperature regulation. The effect of root pressure in transport of water is more important at night. During the day when the stomata are open, the transpiration pull becomes the major driving force in the movement of water in the xylem.

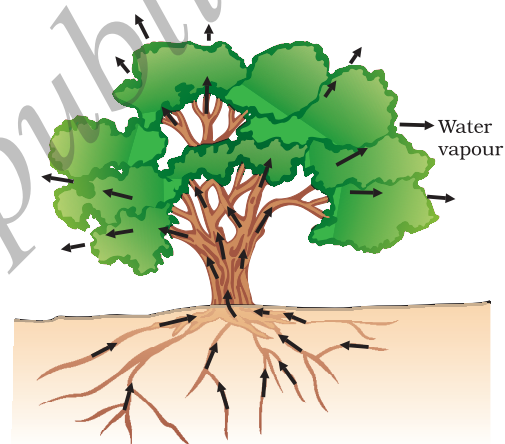

Figure 6.12
Movement of water during transpiration in a tree

Transport of food and other substances

So far we have discussed the transport of water and minerals in plants. Now let us consider how the products of metabolic processes, particularly photosynthesis, are moved from leaves, where they are formed, to other parts of the plant. This transport of soluble products of photosynthesis is called translocation and it occurs in the part of the vascular tissue known as phloem. Besides the products of photosynthesis, the phloem transports amino acids and other substances. These substances are especially delivered to the storage organs of roots, fruits and seeds and to growing organs. The translocation of food and other substances takes place in the sieve tubes with the help of adjacent companion cells both in upward and downward directions.

Unlike transport in xylem which can be largely explained by simple physical forces, the translocation in phloem is achieved by utilising

energy. Material like sucrose is transferred into phloem tissue using energy from ATP. This increases the osmotic pressure of the tissue causing water to move into it. This pressure moves the material in the phloem to tissues which have less pressure. This allows the phloem to move material according to the plant's needs. For example, in the spring, sugar stored in root or stem tissue would be transported to the buds which need energy to grow.

Q U E S T I O N S

1. What are the components of the transport system in human beings? What are the functions of these components?
2. Why is it necessary to separate oxygenated and deoxygenated blood in mammals and birds?
3. What are the components of the transport system in highly organised plants?
4. How are water and minerals transported in plants?
5. How is food transported in plants?

6.5 EXCRETION

We have already discussed how organisms get rid of gaseous wastes generated during photosynthesis or respiration. Other metabolic activities generate nitrogenous materials which need to be removed. The biological process involved in the removal of these harmful metabolic wastes from the body is called excretion. Different organisms use varied strategies to do this. Many unicellular organisms remove these wastes by simple diffusion from the body surface into the surrounding water. As we have seen in other processes, complex multi-cellular organisms use specialised organs to perform the same function.

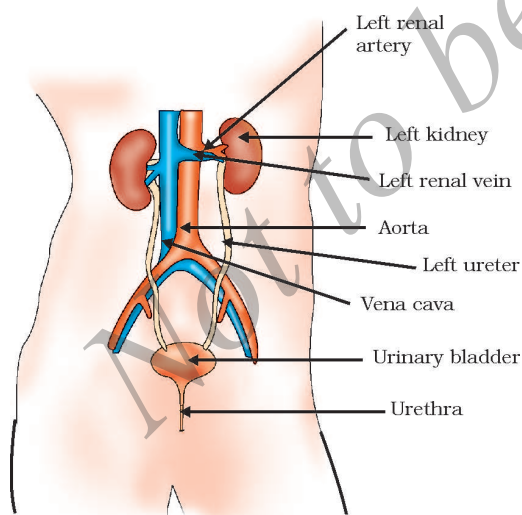

Figure 6.13
Excretory system in human beings

6.5.1 Excretion in Human Beings

The excretory system of human beings (Fig. 6.13) includes a pair of kidneys, a pair of ureters, a urinary bladder and a urethra. Kidneys are located in the abdomen, one on either side of the backbone. Urine produced in the kidneys passes through the ureters into the urinary bladder where it is stored until it is released through the urethra.

How is urine produced? The purpose of making urine is to filter out waste products from the blood. Just as CO_2 is removed from the blood in the lungs, nitrogenous waste such as urea or uric acid are removed from blood in the kidneys. It is then no surprise that the basic filtration unit in the kidneys,

like in the lungs, is a cluster of very thin-walled blood capillaries. Each capillary cluster in the kidney is associated with the cup-shaped end of a coiled tube called Bowman's capsule that collects the filtrate (Fig. 6.14). Each kidney has large numbers of these filtration units called nephrons packed close together. Some substances in the initial filtrate, such as glucose, amino acids, salts and a major amount of water, are selectively re-absorbed as the urine flows along the tube. The amount of water re-absorbed depends on how much excess water there is in the body, and on how much of dissolved waste there is to be excreted. The urine forming in each kidney eventually enters a long tube, the ureter, which connects the kidneys with the urinary bladder. Urine is stored in the urinary bladder until the pressure of the expanded bladder leads to the urge to pass it out through the urethra. The bladder is muscular, so it is under nervous control, as we have discussed elsewhere. As a result, we can usually control the urge to urinate.

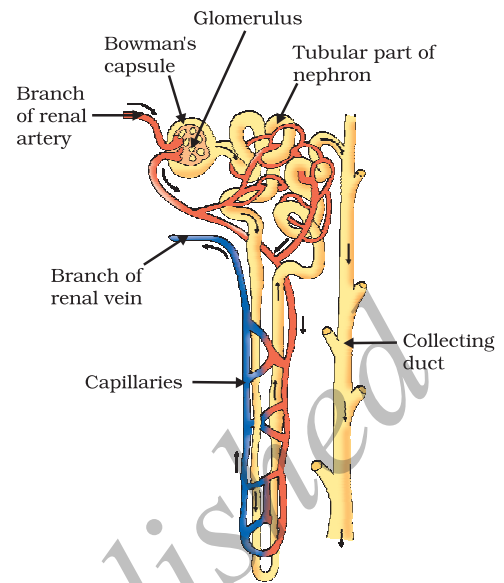

Figure 6.14
Structure of a nephron

Artificial kidney (Hemodialysis)

Kidneys are vital organs for survival. Several factors like infections, injury or restricted blood flow to kidneys reduce the activity of kidneys. This leads to accumulation of poisonous wastes in the body, which can even lead to death. In case of kidney failure, an artificial kidney can be used. An artificial kidney is a device to remove nitrogenous waste products from the blood through *dialysis*.

Artificial kidneys contain a number of tubes with a semi-permeable lining, suspended in a tank filled with dialysing fluid.

This fluid has the same osmotic pressure as blood, except that it is devoid of nitrogenous wastes. The patient's blood is passed through these tubes. During this passage, the waste products from the blood pass into dialysing fluid by diffusion. The purified blood is pumped back into the patient. This is similar to the function of the kidney, but it is different since there is no re-absorption involved. Normally, in a healthy adult, the initial filtrate in the kidneys is about 180 L daily. However, the volume actually excreted is only a litre or two a day, because the remaining filtrate is re-absorbed in the kidney tubules.

More to Know!

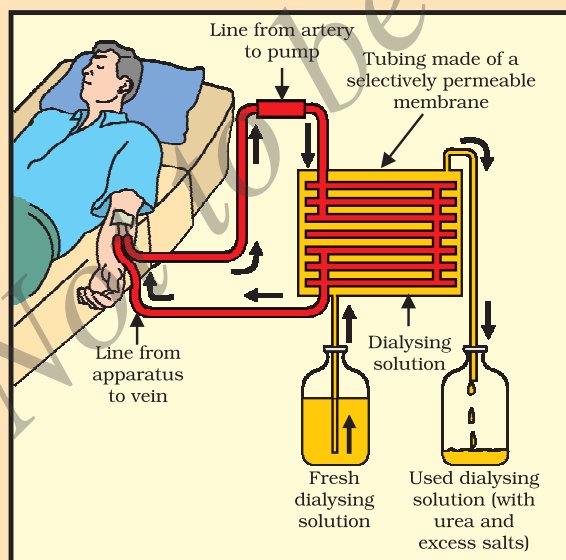

6.5.2 Excretion in Plants

Plants use completely different strategies for excretion than those of animals. Oxygen itself can be thought of as a waste product generated during photosynthesis! We have discussed earlier how plants deal with oxygen as well as CO_2 . They can get rid of excess water by transpiration. For other wastes, plants use the fact that many of their tissues consist of dead cells, and that they can even lose some parts such as leaves. Many plant waste products are stored in cellular vacuoles. Waste products may be stored in leaves that fall off. Other waste products are stored as resins and gums, especially in old xylem. Plants also excrete some waste substances into the soil around them.

Q U E S T I O N S

1. Describe the structure and functioning of nephrons.
2. What are the methods used by plants to get rid of excretory products?
3. How is the amount of urine produced regulated?

What you have learnt

- Movement of various types can be taken as an indication of life.
- Maintenance of life requires processes like nutrition, respiration, transport of materials within the body and excretion of waste products.
- Autotrophic nutrition involves the intake of simple inorganic materials from the environment and using an external energy source like the Sun to synthesise complex high-energy organic material.
- Heterotrophic nutrition involves the intake of complex material prepared by other organisms.
- In human beings, the food eaten is broken down by various steps along the alimentary canal and the digested food is absorbed in the small intestine to be sent to all cells in the body.
- During the process of respiration, organic compounds such as glucose are broken down to provide energy in the form of ATP. ATP is used to provide energy for other reactions in the cell.
- Respiration may be aerobic or anaerobic. Aerobic respiration makes more energy available to the organism.
- In human beings, the transport of materials such as oxygen, carbon dioxide, food and excretory products is a function of the circulatory system. The circulatory system consists of the heart, blood and blood vessels.
- In highly differentiated plants, transport of water, minerals, food and other materials is a function of the vascular tissue which consists of xylem and phloem.

- In human beings, excretory products in the form of soluble nitrogen compounds are removed by the nephrons in the kidneys.
- Plants use a variety of techniques to get rid of waste material. For example, waste material may be stored in the cell-vacuoles or as gum and resin, removed in the falling leaves, or excreted into the surrounding soil.

EXERCISES

- The kidneys in human beings are a part of the system for
 - nutrition.
 - respiration.
 - excretion.
 - transportation.
- The xylem in plants are responsible for
 - transport of water.
 - transport of food.
 - transport of amino acids.
 - transport of oxygen.
- The autotrophic mode of nutrition requires
 - carbon dioxide and water.
 - chlorophyll.
 - sunlight.
 - all of the above.
- The breakdown of pyruvate to give carbon dioxide, water and energy takes place in
 - cytoplasm.
 - mitochondria.
 - chloroplast.
 - nucleus.
- How are fats digested in our bodies? Where does this process take place?
- What is the role of saliva in the digestion of food?
- What are the necessary conditions for autotrophic nutrition and what are its by-products?
- What are the differences between aerobic and anaerobic respiration? Name some organisms that use the anaerobic mode of respiration.
- How are the alveoli designed to maximise the exchange of gases?
- What would be the consequences of a deficiency of haemoglobin in our bodies?
- Describe double circulation of blood in human beings. Why is it necessary?
- What are the differences between the transport of materials in xylem and phloem?
- Compare the functioning of alveoli in the lungs and nephrons in the kidneys with respect to their structure and functioning.

CHAPTER 7

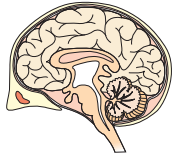

Control and Coordination



In the previous chapter, we looked at life processes involved in the maintenance functions in living organisms. There, we had started with a notion we all have, that if we see something moving, it is alive. Some of these movements are in fact the result of growth, as in plants. A seed germinates and grows, and we can see that the seedling moves over the course of a few days, it pushes soil aside and comes out. But if its growth were to be stopped, these movements would not happen. Some movements, as in many animals and some plants, are not connected with growth. A cat running, children playing on swings, buffaloes chewing cud – these are not movements caused by growth.

Why do we associate such visible movements with life? A possible answer is that we think of movement as a response to a change in the environment of the organism. The cat may be running because it has seen a mouse. Not only that, we also think of movement as an attempt by living organisms to use changes in their environment to their advantage. Plants grow out into the sunshine. Children try to get pleasure and fun out of swinging. Buffaloes chew cud to help break up tough food so as to be able to digest it better. When bright light is focussed on our eyes or when we touch a hot object, we detect the change and respond to it with movement in order to protect ourselves.

If we think a bit more about this, it becomes apparent that all this movement, in response to the environment, is carefully controlled. Each kind of a change in the environment evokes an appropriate movement in response. When we want to talk to our friends in class, we whisper, rather than shouting loudly. Clearly, the movement to be made depends on the event that is triggering it. Therefore, such controlled movement must be connected to the recognition of various events in the environment, followed by only the correct movement in response. In other words, living organisms must use systems providing control and coordination. In keeping with the general principles of body organisation in multicellular organisms, specialised tissues are used to provide these control and coordination activities.

7.1 ANIMALS – NERVOUS SYSTEM

In animals, such control and coordination are provided by nervous and muscular tissues, which we have studied in Class IX. Touching a hot

object is an urgent and dangerous situation for us. We need to detect it, and respond to it. How do we detect that we are touching a hot object? All information from our environment is detected by the specialised tips of some nerve cells. These receptors are usually located in our sense organs, such as the inner ear, the nose, the tongue, and so on. So gustatory receptors will detect taste while olfactory receptors will detect smell.

This information, acquired at the end of the dendritic tip of a nerve cell [Fig. 7.1 (a)], sets off a chemical reaction that creates an electrical impulse. This impulse travels from the dendrite to the cell body, and then along the axon to its end. At the end of the axon, the electrical impulse sets off the release of some chemicals. These chemicals cross the gap, or synapse, and start a similar electrical impulse in a dendrite of the next neuron. This is a general scheme of how nervous impulses travel in the body. A similar synapse finally allows delivery of such impulses from neurons to other cells, such as muscles cells or gland [Fig. 7.1 (b)].

It is thus no surprise that nervous tissue is made up of an organised network of nerve cells or neurons, and is specialised for conducting information via electrical impulses from one part of the body to another.

Look at Fig. 7.1 (a) and identify the parts of a neuron (i) where information is acquired, (ii) through which information travels as an electrical impulse, and (iii) where this impulse must be converted into a chemical signal for onward transmission.

Look at Fig. 7.1 (a) and identify the parts of a neuron (i) where information is acquired, (ii) through which information travels as an electrical impulse, and (iii) where this impulse must be converted into a chemical signal for onward transmission.

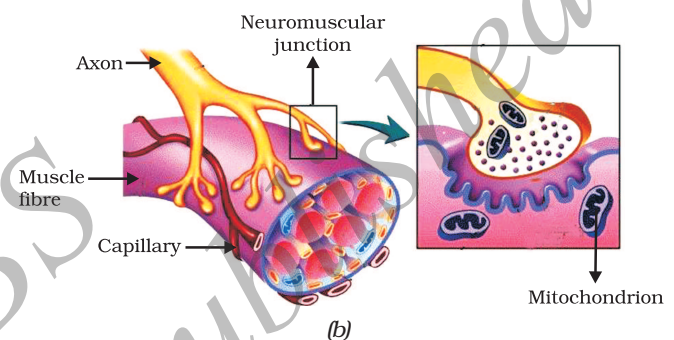
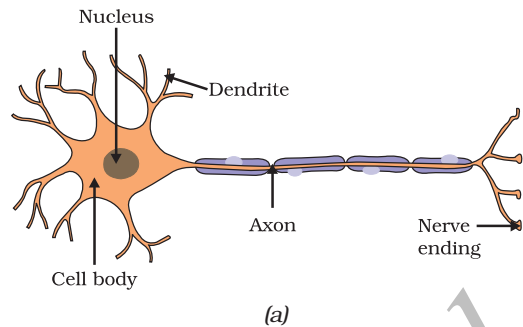

Figure 7.1 (a) Structure of neuron, (b) Neuromuscular junction

Activity 7.1

- Put some sugar in your mouth. How does it taste?
- Block your nose by pressing it between your thumb and index finger. Now eat sugar again. Is there any difference in its taste?
- While eating lunch, block your nose in the same way and notice if you can fully appreciate the taste of the food you are eating.

Is there a difference in how sugar and food taste if your nose is blocked? If so, why might this be happening? Read and talk about possible explanations for these kinds of differences. Do you come across a similar situation when you have a cold?

7.1.1 What happens in Reflex Actions?

'Reflex' is a word we use very commonly when we talk about some sudden action in response to something in the environment. We say 'I jumped out of the way of the bus reflexly', or 'I pulled my hand back from the flame reflexly', or 'I was so hungry my mouth started watering reflexly'. What exactly do we mean? A common idea in all such examples is that we do something without thinking about it, or without feeling in control of our reactions. Yet these are situations where we are responding with some action to changes in our environment. How is control and coordination achieved in such situations?

Let us consider this further. Take one of our examples. Touching a flame is an urgent and dangerous situation for us, or in fact, for any animal! How would we respond to this? One seemingly simple way is to think consciously about the pain and the possibility of getting burnt, and therefore move our hand. An important question then is, how long will it take us to think all this? The answer depends on how we think. If nerve impulses are sent around the way we have talked about earlier, then thinking is also likely to involve the creation of such impulses. Thinking is a complex activity, so it is bound to involve a complicated interaction of many nerve impulses from many neurons.

If this is the case, it is no surprise that the thinking tissue in our body consists of dense networks of intricately arranged neurons. It sits in the forward end of the skull, and receives signals from all over the body which it thinks about before responding to them. Obviously, in order to receive these signals, this thinking part of the brain in the skull must be connected to nerves coming from various parts of the body. Similarly, if this part of the brain is to instruct muscles to move, nerves must carry this signal back to different parts of the body. If all of this is to be done when we touch a hot object, it may take enough time for us to get burnt!

How does the design of the body solve this problem? Rather than having to think about the sensation of heat, if the nerves that detect heat were to be connected to the nerves that move muscles in a simpler way, the process of detecting the signal or the input and responding to it by an output action might be completed quickly. Such a connection is commonly called a reflex arc (Fig. 7.2). Where should such reflex arc connections be made between the input nerve and the output nerve? The best place, of course, would be at the point where they first meet each other. Nerves from all over the body meet in a bundle in the spinal cord on their way to the brain. Reflex arcs are formed in this spinal cord itself, although the information input also goes on to reach the brain.

Of course, reflex arcs have evolved in animals because the thinking process of the brain is not fast enough. In fact many animals have very little or none of the complex neuron network needed for thinking. So it is quite likely that reflex arcs have evolved as efficient ways of functioning in the absence of true thought processes. However, even after complex neuron networks have come into existence, reflex arcs continue to be more efficient for quick responses.

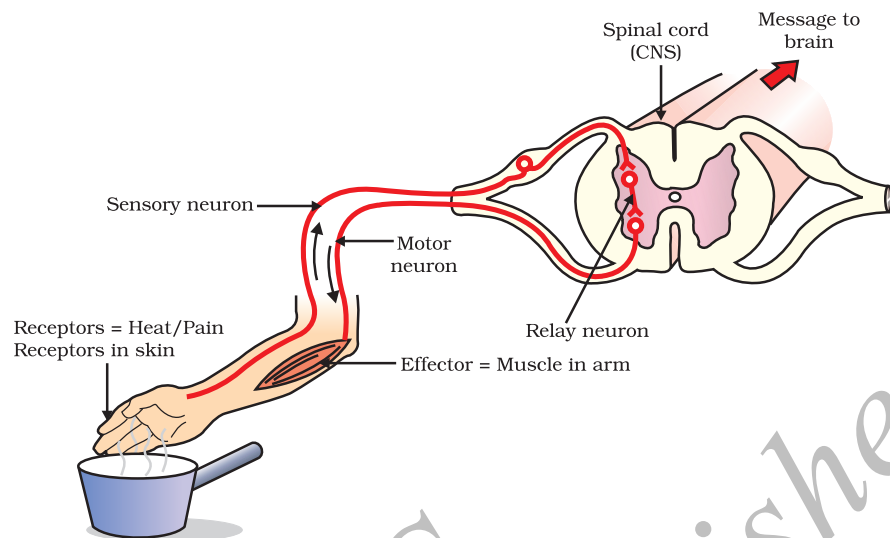

Figure 7.2 Reflex arc

Can you now trace the sequence of events which occur when a bright light is focussed on your eyes?

7.1.2 Human Brain

Is reflex action the only function of the spinal cord? Obviously not, since we know that we are thinking beings. Spinal cord is made up of nerves which supply information to think about. Thinking involves more complex mechanisms and neural connections. These are concentrated in the brain, which is the main coordinating centre of the body. The brain and spinal cord constitute the central nervous system. They receive information from all parts of the body and integrate it.

We also think about our actions. Writing, talking, moving a chair, clapping at the end of a programme are examples of voluntary actions which are based on deciding what to do next. So, the brain also has to send messages to muscles. This is the second way in which the nervous system communicates with the muscles. The communication between the central nervous system and the other parts of the body is facilitated by the peripheral nervous system consisting of cranial nerves arising from the brain and spinal nerves arising from the spinal cord. The brain thus allows us to think and take actions based on that thinking. As you will expect, this is accomplished through a complex design, with different parts of the brain responsible for integrating different inputs and outputs. The brain has three such major parts or regions, namely the fore-brain, mid-brain and hind-brain.

The fore-brain is the main thinking part of the brain. It has regions which receive sensory impulses from various receptors. Separate areas of the fore-brain are specialised for hearing, smell, sight and so on. There are separate areas of association where this sensory information is interpreted by putting it together with information from other receptors as well as with information that is already stored in the brain. Based on

all this, a decision is made about how to respond and the information is passed on to the motor areas which control the movement of voluntary muscles, for example, our leg muscles. However, certain sensations are distinct from seeing or hearing, for example, how do we know that we have eaten enough? The sensation of feeling full is because of a centre associated with hunger, which is in a separate part of the fore-brain.

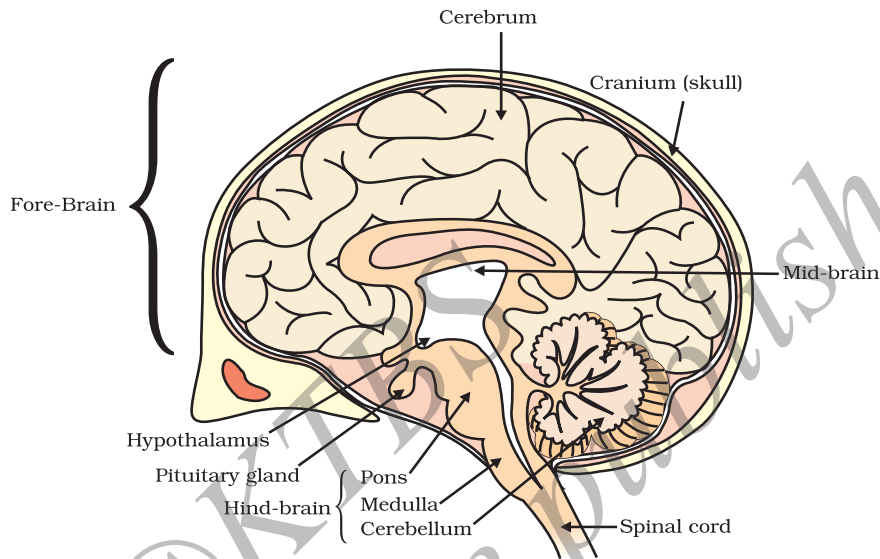

Figure 7.3 Human brain

Study the labelled diagram of the human brain. We have seen that the different parts have specific functions. Can we find out the function of each part?

Let us look at the other use of the word 'reflex' that we have talked about in the introduction. Our mouth waters when we see food we like without our meaning to. Our hearts beat without our thinking about it. In fact, we cannot control these actions easily by thinking about them even if we wanted to. Do we have to think about or remember to breathe or digest food? So, in between the simple reflex actions like change in the size of the pupil, and the thought out actions such as moving a chair, there is another set of muscle movements over which we do not have any thinking control. Many of these involuntary actions are controlled by the mid-brain and hind-brain. All these involuntary actions including blood pressure, salivation and vomiting are controlled by the medulla in the hind-brain.

Think about activities like walking in a straight line, riding a bicycle, picking up a pencil. These are possible due to a part of the hind-brain called the cerebellum. It is responsible for precision of voluntary actions and maintaining the posture and balance of the body. Imagine what would happen if each of these events failed to take place if we were not thinking about it.

7.1.3 How are these Tissues protected?

A delicate organ like the brain, which is so important for a variety of activities, needs to be carefully protected. For this, the body is designed so that the brain sits inside a bony box. Inside the box, the brain is contained in a fluid-filled balloon which provides further shock absorption. If you run your hand down the middle of your back, you will feel a hard, bumpy structure. This is the vertebral column or backbone which protects the spinal cord.

7.1.4 How does the Nervous Tissue cause Action?

So far, we have been talking about nervous tissue, and how it collects information, sends it around the body, processes information, makes decisions based on information, and conveys decisions to muscles for action. In other words, when the action or movement is to be performed, muscle tissue will do the final job. How do animal muscles move? When a nerve impulse reaches the muscle, the muscle fibre must move. How does a muscle cell move? The simplest notion of movement at the cellular level is that muscle cells will move by changing their shape so that they shorten. So the next question is, how do muscle cells change their shape? The answer must lie in the chemistry of cellular components. Muscle cells have special proteins that change both their shape and their arrangement in the cell in response to nervous electrical impulses. When this happens, new arrangements of these proteins give the muscle cells a shorter form. Remember when we talked about muscle tissue in Class IX, there were different kinds of muscles, such as voluntary muscles and involuntary muscles. Based on what we have discussed so far, what do you think the differences between these would be?

Q U E S T I O N S

1. What is the difference between a reflex action and walking?
2. What happens at the synapse between two neurons?
3. Which part of the brain maintains posture and equilibrium of the body?
4. How do we detect the smell of an *agarbatti* (incense stick)?
5. What is the role of the brain in reflex action?



7.2 COORDINATION IN PLANTS

Animals have a nervous system for controlling and coordinating the activities of the body. But plants have neither a nervous system nor muscles. So, how do they respond to stimuli? When we touch the leaves of a *chhui-mui* (the 'sensitive' or 'touch-me-not' plant of the Mimosa family), they begin to fold up and droop. When a seed germinates, the root goes down, the stem comes up into the air. What happens? Firstly, the leaves of the sensitive plant move very quickly in response to touch.

There is no growth involved in this movement. On the other hand, the directional movement of a seedling is caused by growth. If it is prevented from growing, it will not show any movement. So plants show two different types of movement – one dependent on growth and the other independent of growth.

7.2.1 Immediate Response to Stimulus

Let us think about the first kind of movement, such as that of the sensitive plant. Since no growth is involved, the plant must actually move its leaves in response to touch. But there is no nervous tissue, nor any muscle tissue. How does the plant detect the touch, and how do the leaves move in response?



Figure 7.4 The sensitive plant

If we think about where exactly the plant is touched, and what part of the plant actually moves, it is apparent that movement happens at a point different from the point of touch. So, information that a touch has occurred must be communicated. The plants also use electrical-chemical means to convey this information from cell to cell, but unlike in animals, there is no specialised tissue in plants for the conduction of information. Finally, again as in animals, some cells must change shape in order for movement to happen. Instead of the specialised proteins found in animal muscle cells, plant cells change shape by changing the amount of water in them, resulting in swelling or shrinking, and therefore in changing shapes.

7.2.2 Movement Due to Growth

Some plants like the pea plant climb up other plants or fences by means of tendrils. These tendrils are sensitive to touch. When they come in contact with any support, the part of the tendril in contact with the object does not grow as rapidly as the part of the tendril away from the object. This causes the tendril to circle around the object and thus cling to it. More commonly, plants respond to stimuli slowly by growing in a particular direction. Because this growth is directional, it appears as if the plant is moving. Let us understand this type of movement with the help of an example.

Activity 7.2

- Fill a conical flask with water.
- Cover the neck of the flask with a wire mesh.
- Keep two or three freshly germinated bean seeds on the wire mesh.
- Take a cardboard box which is open from one side.
- Keep the flask in the box in such a manner that the open side of the box faces light coming from a window (Fig. 7.5).
- After two or three days, you will notice that the shoots bend towards light and roots away from light.
- Now turn the flask so that the shoots are away from light and the roots towards light. Leave it undisturbed in this condition for a few days.
- Have the old parts of the shoot and root changed direction?
- Are there differences in the direction of the new growth?
- What can we conclude from this activity?

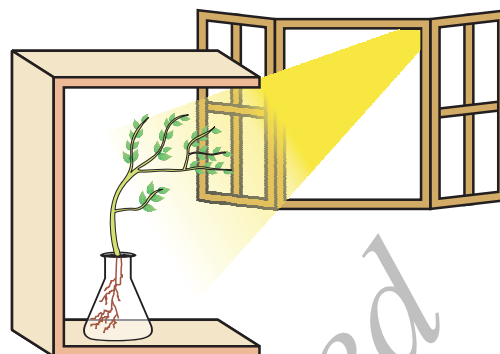

Figure 7.5
Response of the plant to the direction of light

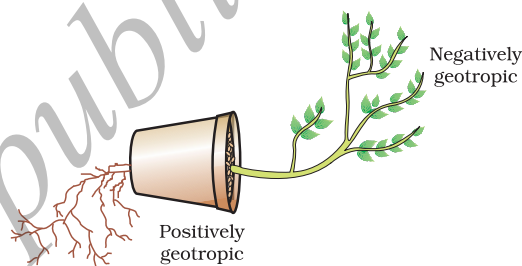

Figure 7.6 Plant showing geotropism

Environmental triggers such as light, or gravity will change the directions that plant parts grow in. These directional, or tropic, movements can be either towards the stimulus, or away from it. So, in two different kinds of phototropic movement, shoots respond by bending towards light while roots respond by bending away from it. How does this help the plant?

Plants show tropism in response to other stimuli as well. The roots of a plant always grow downwards while the shoots usually grow upwards and away from the earth. This upward and downward growth of shoots and roots, respectively, in response to the pull of earth or gravity is, obviously, geotropism (Fig. 7.6). If 'hydro' means water and 'chemo' refers to chemicals, what would 'hydrotropism' and 'chemotropism' mean? Can we think of examples of these kinds of directional growth movements? One example of chemotropism is the growth of pollen tubes towards ovules, about which we will learn more when we examine the reproductive processes of living organisms.

Let us now once again think about how information is communicated in the bodies of multicellular organisms. The movement of the sensitive plant in response to touch is very quick. The movement of sunflowers in response to day or night, on the other hand, is quite slow. Growth-related movement of plants will be even slower.

Even in animal bodies, there are carefully controlled directions to growth. Our arms and fingers grow in certain directions, not haphazardly. So controlled movements can be either slow or fast. If fast responses to stimuli are to be made, information transfer must happen very quickly. For this, the medium of transmission must be able to move rapidly.

Control and Coordination

Electrical impulses are an excellent means for this. But there are limitations to the use of electrical impulses. Firstly, they will reach only those cells that are connected by nervous tissue, not each and every cell in the animal body. Secondly, once an electrical impulse is generated in a cell and transmitted, the cell will take some time to reset its mechanisms before it can generate and transmit a new impulse. In other words, cells cannot continually create and transmit electrical impulses. It is thus no wonder that most multicellular organisms use another means of communication between cells, namely, chemical communication.

If, instead of generating an electrical impulse, stimulated cells release a chemical compound, this compound would diffuse all around the original cell. If other cells around have the means to detect this compound using special molecules on their surfaces, then they would be able to recognise information, and even transmit it. This will be slower, of course, but it can potentially reach all cells of the body, regardless of nervous connections, and it can be done steadily and persistently. These compounds, or hormones used by multicellular organisms for control and coordination show a great deal of diversity, as we would expect. Different plant hormones help to coordinate growth, development and responses to the environment. They are synthesised at places away from where they act and simply diffuse to the area of action.

Let us take an example that we have worked with earlier [Activity 7.2]. When growing plants detect light, a hormone called auxin, synthesised at the shoot tip, helps the cells to grow longer. When light is coming from one side of the plant, auxin diffuses towards the shady side of the shoot. This concentration of auxin stimulates the cells to grow longer on the side of the shoot which is away from light. Thus, the plant appears to bend towards light.

Another example of plant hormones are gibberellins which, like auxins, help in the growth of the stem. Cytokinins promote cell division, and it is natural then that they are present in greater concentration in areas of rapid cell division, such as in fruits and seeds. These are examples of plant hormones that help in promoting growth. But plants also need signals to stop growing. Abscisic acid is one example of a hormone which inhibits growth. Its effects include wilting of leaves.

Q U E S T I O N S

1. What are plant hormones?
2. How is the movement of leaves of the sensitive plant different from the movement of a shoot towards light?
3. Give an example of a plant hormone that promotes growth.
4. How do auxins promote the growth of a tendril around a support?
5. Design an experiment to demonstrate hydrotropism.



7.3 HORMONES IN ANIMALS

How are such chemical, or hormonal, means of information transmission used in animals? What do some animals, for instance squirrels, experience when they are in a scary situation? Their bodies have to prepare for either fighting or running away. Both are very complicated activities that will use a great deal of energy in controlled ways. Many different tissue types will be used and their activities integrated together in these actions. However, the two alternate activities, fighting or running, are also quite different! So here is a situation in which some common preparations can be usefully made in the body. These preparations should ideally make it easier to do either activity in the near future. How would this be achieved?

If the body design in the squirrel relied only on electrical impulses via nerve cells, the range of tissues instructed to prepare for the coming activity would be limited. On the other hand, if a chemical signal were to be sent as well, it would reach all cells of the body and provide the wide-ranging changes needed. This is done in many animals, including human beings, using a hormone called adrenaline that is secreted from the adrenal glands. Look at Fig. 7.7 to locate these glands.

Adrenaline is secreted directly into the blood and carried to different parts of the body. The target organs or the specific tissues on which it acts include the heart. As a result, the heart beats faster, resulting in supply of more oxygen to our muscles. The blood to the digestive system and skin is reduced due to contraction of muscles around small arteries in these organs. This diverts the blood to our skeletal muscles. The breathing rate also increases because of the contractions of the diaphragm and the rib muscles. All these responses together enable the animal body to be ready to deal with the situation. Such animal hormones are part of the endocrine system which constitutes a second way of control and coordination in our body.

Activity 7.3

- Look at Fig. 7.7.
- Identify the endocrine glands mentioned in the figure.
- Some of these glands have been listed in Table 7.1 and discussed in the text. Consult books in the library and discuss with your teachers to find out about other glands.

Remember that plants have hormones that control their directional growth. What functions do animal hormones perform? On the face of it, we cannot imagine their role in directional growth. We have never seen an animal growing more in one direction or the other, depending on light or gravity! But if we think about it a bit more, it will become evident that, even in animal bodies, growth happens in carefully controlled places. Plants will grow leaves in many places on the plant body, for example. But we do not grow fingers on our faces. The design of the body is carefully maintained even during the growth of children.

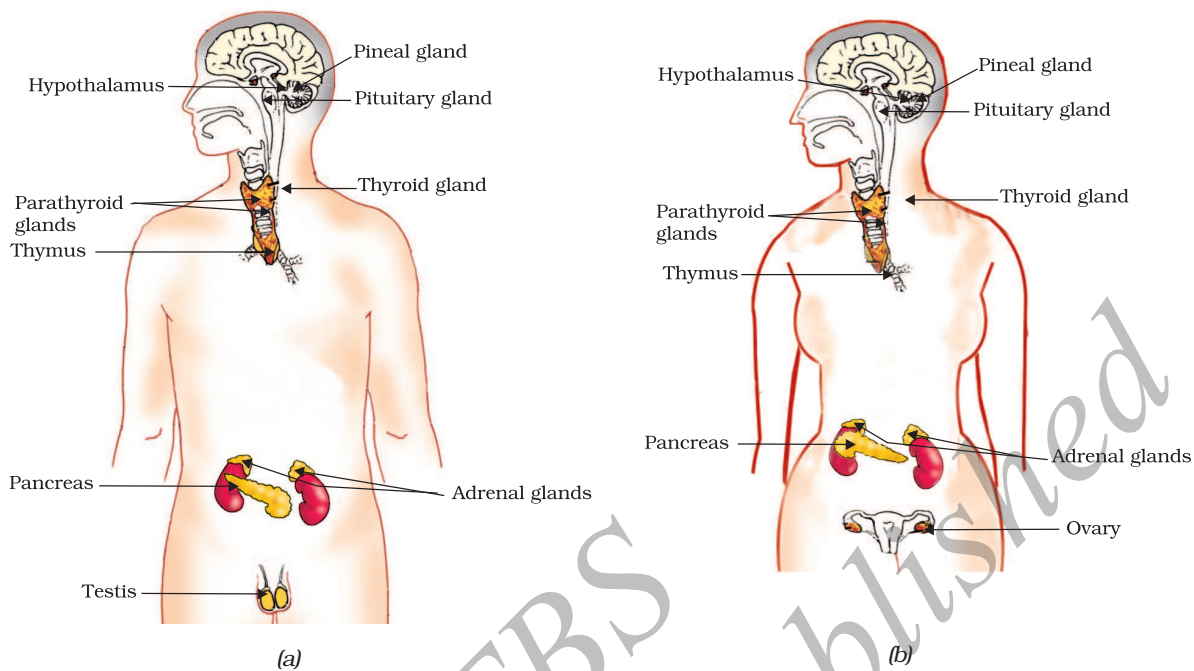

Figure 7.7 Endocrine glands in human beings (a) male, (b) female

Do You Know?

Hypothalamus plays an important role in the release of many hormones. For example, when the level of growth hormone is low, the hypothalamus releases growth hormone releasing factor which stimulates the pituitary gland to release growth hormone.

Let us examine some examples to understand how hormones help in coordinated growth. We have all seen salt packets which say 'iodised salt' or 'enriched with iodine'. Why is it important for us to have iodised salt in our diet? Iodine is necessary for the thyroid gland to make thyroxin hormone. Thyroxin regulates carbohydrate, protein and fat metabolism in the body so as to provide the best balance for growth. Iodine is essential for the synthesis of thyroxin. In case iodine is deficient in our diet, there is a possibility that we might suffer from goitre. One of the symptoms in this disease is a swollen neck. Can you correlate this with the position of the thyroid gland in Fig. 7.7?

Sometimes we come across people who are either very short (dwarfs) or extremely tall (giants). Have you ever wondered how this happens? Growth hormone is one of the hormones secreted by the pituitary. As its name indicates, growth hormone regulates growth and development of the body. If there is a deficiency of this hormone in childhood, it leads to dwarfism.

You must have noticed many dramatic changes in your appearance as well as that of your friends as you approached 10–12 years of age. These changes associated with puberty are because of the secretion of testosterone in males and oestrogen in females.

Do you know anyone in your family or friends who has been advised by the doctor to take less sugar in their diet because they are suffering from diabetes? As a treatment, they might be taking injections of insulin. This is a hormone which is produced by the pancreas and helps in regulating blood sugar levels. If it is not secreted in proper amounts, the sugar level in the blood rises causing many harmful effects.

If it is so important that hormones should be secreted in precise quantities, we need a mechanism through which this is done. The timing and amount of hormone released are regulated by feedback mechanisms. For example, if the sugar levels in blood rise, they are detected by the cells of the pancreas which respond by producing more insulin. As the blood sugar level falls, insulin secretion is reduced.

Activity 7.4

- Hormones are secreted by endocrine glands and have specific functions. Complete Table 7.1 based on the hormone, the endocrine gland or the functions provided.

Table 7.1 : Some important hormones and their functions

S.No.	Hormone	Endocrine Gland	Functions
1.	Growth hormone	Pituitary gland	Stimulates growth in all organs
2.		Thyroid gland	Regulates metabolism for body growth
3.	Insulin		Regulates blood sugar level
4.	Testosterone	Testes	
5.		Ovaries	Development of female sex organs, regulates menstrual cycle, etc.
6.	Adrenaline	Adrenal gland	
7.	Releasing hormones		Stimulates pituitary gland to release hormones

Q U E S T I O N S

- How does chemical coordination take place in animals?
- Why is the use of iodised salt advisable?
- How does our body respond when adrenaline is secreted into the blood?
- Why are some patients of diabetes treated by giving injections of insulin?

What you have learnt

- Control and coordination are the functions of the nervous system and hormones in our bodies.
- The responses of the nervous system can be classified as reflex action, voluntary action or involuntary action.
- The nervous system uses electrical impulses to transmit messages.
- The nervous system gets information from our sense organs and acts through our muscles.
- Chemical coordination is seen in both plants and animals.
- Hormones produced in one part of an organism move to another part to achieve the desired effect.
- A feedback mechanism regulates the action of the hormones.

EXERCISES

- Which of the following is a plant hormone?
 - Insulin
 - Thyroxin
 - Oestrogen
 - Cytokinin.
- The gap between two neurons is called a
 - dendrite.
 - synapse.
 - axon.
 - impulse.
- The brain is responsible for
 - thinking.
 - regulating the heart beat.
 - balancing the body.
 - all of the above.
- What is the function of receptors in our body? Think of situations where receptors do not work properly. What problems are likely to arise?
- Draw the structure of a neuron and explain its function.
- How does phototropism occur in plants?
- Which signals will get disrupted in case of a spinal cord injury?
- How does chemical coordination occur in plants?
- What is the need for a system of control and coordination in an organism?
- How are involuntary actions and reflex actions different from each other?
- Compare and contrast nervous and hormonal mechanisms for control and coordination in animals.
- What is the difference between the manner in which movement takes place in a sensitive plant and the movement in our legs?

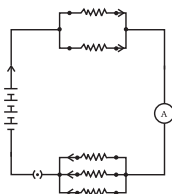

CHAPTER 12

Electricity



Electricity has an important place in modern society. It is a controllable and convenient form of energy for a variety of uses in homes, schools, hospitals, industries and so on. What constitutes electricity? How does it flow in an electric circuit? What are the factors that control or regulate the current through an electric circuit? In this Chapter, we shall attempt to answer such questions. We shall also discuss the heating effect of electric current and its applications.

12.1 ELECTRIC CURRENT AND CIRCUIT

We are familiar with air current and water current. We know that flowing water constitute water current in rivers. Similarly, if the electric charge flows through a conductor (for example, through a metallic wire), we say that there is an electric current in the conductor. In a torch, we know that the cells (or a battery, when placed in proper order) provide flow of charges or an electric current through the torch bulb to glow. We have also seen that the torch gives light only when its switch is *on*. What does a switch do? A switch makes a conducting link between the cell and the bulb. A continuous and closed path of an electric current is called an electric circuit. Now, if the circuit is broken anywhere (or the switch of the torch is turned *off*), the current stops flowing and the bulb does not glow.

How do we express electric current? Electric current is expressed by the amount of charge flowing through a particular area in unit time. In other words, it is the rate of flow of electric charges. In circuits using metallic wires, electrons constitute the flow of charges. However, electrons were not known at the time when the phenomenon of electricity was first observed. So, electric current was considered to be the flow of positive charges and the direction of flow of positive charges was taken to be the direction of electric current. Conventionally, in an electric circuit the direction of electric current is taken as opposite to the direction of the flow of electrons, which are negative charges.

If a net charge Q , flows across any cross-section of a conductor in time t , then the current I , through the cross-section is

$$I = \frac{Q}{t} \quad (12.1)$$

The SI unit of electric charge is coulomb (C), which is equivalent to the charge contained in nearly 6×10^{18} electrons. (We know that an electron possesses a negative charge of 1.6×10^{-19} C.) The electric current is expressed by a unit called ampere (A), named after the French scientist, Andre-Marie Ampere (1775–1836). One ampere is constituted by the flow of one coulomb of charge per second, that is, $1 \text{ A} = 1 \text{ C}/1 \text{ s}$. Small quantities of current are expressed in milliampere (1 mA = 10^{-3} A) or in microampere (1 $\mu\text{A} = 10^{-6}$ A).

An instrument called ammeter measures electric current in a circuit. It is always connected in series in a circuit through which the current is to be measured. Figure 12.1 shows the schematic diagram of a typical electric circuit comprising a cell, an electric bulb, an ammeter and a plug key. Note that the electric current flows in the circuit from the positive terminal of the cell to the negative terminal of the cell through the bulb and ammeter.

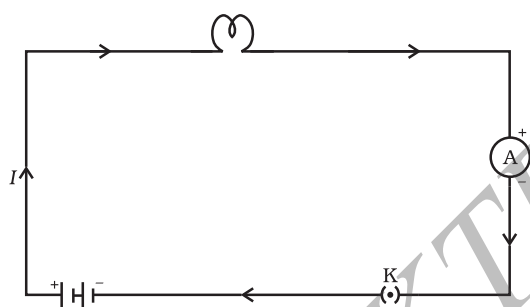

Figure 12.1
A schematic diagram of an electric circuit comprising – cell, electric bulb, ammeter and plug key

Example 12.1

A current of 0.5 A is drawn by a filament of an electric bulb for 10 minutes. Find the amount of electric charge that flows through the circuit.

Solution

We are given, $I = 0.5 \text{ A}$; $t = 10 \text{ min} = 600 \text{ s}$.

From Eq. (12.1), we have

$$\begin{aligned} Q &= It \\ &= 0.5 \text{ A} \times 600 \text{ s} \\ &= 300 \text{ C} \end{aligned}$$

Q U E S T I O N S

1. What does an electric circuit mean?
2. Define the unit of current.
3. Calculate the number of electrons constituting one coulomb of charge.



'Flow' of charges inside a wire

How does a metal conduct electricity? You would think that a low-energy electron would have great difficulty passing through a solid conductor. Inside the solid, the atoms are packed together with very little spacing between them. But it turns out that the electrons are able to 'travel' through a perfect solid crystal smoothly and easily, almost as if they were in a vacuum. The 'motion' of electrons in a conductor, however, is very different from that of charges in empty space. When a steady current flows through a conductor, the electrons in it move with a certain average 'drift speed'. One can calculate this drift speed of electrons for a typical copper wire carrying a small current, and it is found to be actually very small, of the order of 1 mm s^{-1} . How is it then that an electric bulb lights up as soon as we turn the switch *on*? It cannot be that a current starts only when an electron from one terminal of the electric supply physically reaches the other terminal through the bulb, because the physical drift of electrons in the conducting wires is a very slow process. The exact mechanism of the current flow, which takes place with a speed close to the speed of light, is fascinating, but it is beyond the scope of this book. Do you feel like probing this question at an advanced level?

12.2 ELECTRIC POTENTIAL AND POTENTIAL DIFFERENCE

What makes the electric charge to flow? Let us consider the analogy of flow of water. Charges do not flow in a copper wire by themselves, just as water in a perfectly horizontal tube does not flow. If one end of the tube is connected to a tank of water kept at a higher level, such that there is a pressure difference between the two ends of the tube, water flows out of the other end of the tube. For flow of charges in a conducting metallic wire, the gravity, of course, has no role to play; the electrons move only if there is a difference of electric pressure – called the *potential difference* – along the conductor. This difference of potential may be produced by a battery, consisting of one or more electric cells. The chemical action within a cell generates the potential difference across the terminals of the cell, even when no current is drawn from it. When the cell is connected to a conducting circuit element, the potential difference sets the charges in motion in the conductor and produces an electric current. In order to maintain the current in a given electric circuit, the cell has to expend its chemical energy stored in it.

We define the electric potential difference between two points in an electric circuit carrying some current as the work done to move a unit charge from one point to the other –

$$\text{Potential difference (V) between two points} = \text{Work done (W)}/\text{Charge (Q)}$$

$$V = W/Q \quad (12.2)$$

The SI unit of electric potential difference is volt (V), named after Alessandro Volta (1745–1827), an Italian physicist. One volt is the

potential difference between two points in a current carrying conductor when 1 joule of work is done to move a charge of 1 coulomb from one point to the other.

$$\text{Therefore, } 1 \text{ volt} = \frac{1 \text{ joule}}{1 \text{ coulomb}} \quad (12.3)$$

$$1 \text{ V} = 1 \text{ J C}^{-1}$$

The potential difference is measured by means of an instrument called the voltmeter. The voltmeter is always connected in parallel across the points between which the potential difference is to be measured.

Example 12.2

How much work is done in moving a charge of 2 C across two points having a potential difference 12 V?

Solution

The amount of charge Q , that flows between two points at potential difference V (= 12 V) is 2 C. Thus, the amount of work W , done in moving the charge [from Eq. (12.2)] is

$$\begin{aligned} W &= VQ \\ &= 12 \text{ V} \times 2 \text{ C} \\ &= 24 \text{ J.} \end{aligned}$$

Q U E S T I O N S





1. Name a device that helps to maintain a potential difference across a conductor.
2. What is meant by saying that the potential difference between two points is 1 V?
3. How much energy is given to each coulomb of charge passing through a 6 V battery?

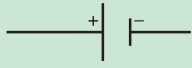
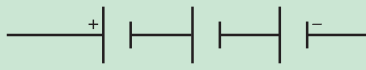
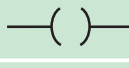
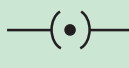

12.3 CIRCUIT DIAGRAM

We know that an electric circuit, as shown in Fig. 12.1, comprises a cell (or a battery), a plug key, electrical component(s), and connecting wires. It is often convenient to draw a schematic diagram, in which different components of the circuit are represented by the symbols conveniently used. Conventional symbols used to represent some of the most commonly used electrical components are given in Table 12.1.

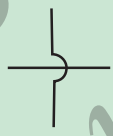
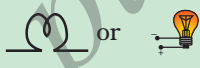
Table 12.1 Symbols of some commonly used components in circuit diagrams

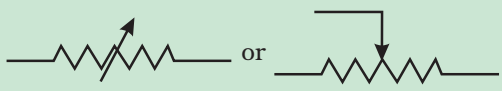
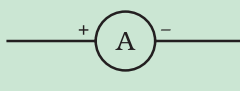
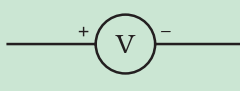
Sl. No.	Components	Symbols
1	An electric cell	
2	A battery or a combination of cells	
3	Plug key or switch (open)	
4	Plug key or switch (closed)	
5	A wire joint	
6	Wires crossing without joining	
7	Electric bulb	
8	A resistor of resistance R	
9	Variable resistance or rheostat	
10	Ammeter	
11	Voltmeter	

12.4 OHM'S LAW

Is there a relationship between the potential difference across a conductor and the current through it? Let us explore with an Activity.

Activity 12.1

- Set up a circuit as shown in Fig. 12.2, consisting of a nichrome wire XY of length, say 0.5 m, an ammeter, a voltmeter and four cells of 1.5 V each. (Nichrome is an alloy of nickel, chromium, manganese, and iron metals.)

- First use only one cell as the source in the circuit. Note the reading in the ammeter I , for the current and reading of the voltmeter V for the potential difference across the nichrome wire XY in the circuit. Tabulate them in the Table given.
- Next connect two cells in the circuit and note the respective readings of the ammeter and voltmeter for the values of current through the nichrome wire and potential difference across the nichrome wire.
- Repeat the above steps using three cells and then four cells in the circuit separately.
- Calculate the ratio of V to I for each pair of potential difference V and current I .

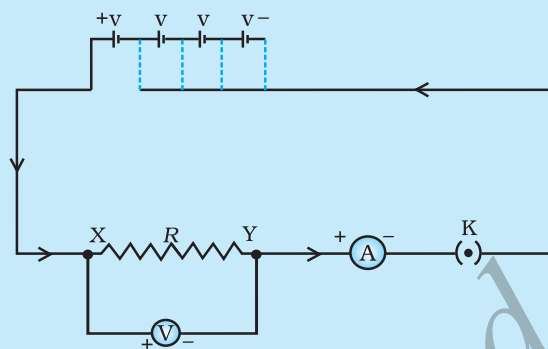

Figure 12.2 Electric circuit for studying Ohm's law

S. No.	Number of cells used in the circuit	Current through the nichrome wire, I (ampere)	Potential difference across the nichrome wire, V (volt)	V/I (volt/ampere)
1	1			
2	2			
3	3			
4	4			

- Plot a graph between V and I , and observe the nature of the graph.

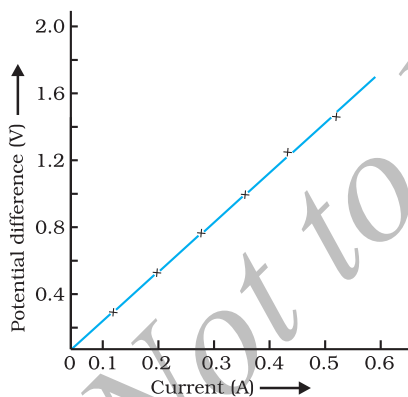

Figure 12.3 V - I graph for a nichrome wire. A straight line plot shows that as the current through a wire increases, the potential difference across the wire increases linearly – this is Ohm's law.

In this Activity, you will find that approximately the same value for V/I is obtained in each case. Thus the V - I graph is a straight line that passes through the origin of the graph, as shown in Fig. 12.3. Thus, V/I is a constant ratio.

In 1827, a German physicist Georg Simon Ohm (1787–1854) found out the relationship between the current I , flowing in a metallic wire and the potential difference across its terminals. The potential difference, V , across the ends of a given metallic wire in an electric circuit is directly proportional to the current flowing through it, provided its temperature remains the same. This is called Ohm's law. In other words –

$$V \propto I \quad (12.4)$$

$$\text{or} \quad \frac{V}{I} = \text{constant} \\ = R$$

$$\text{or} \quad V = IR \quad (12.5)$$

In Eq. (12.4), R is a constant for the given metallic wire at a given temperature and is called its resistance. It is the property of a conductor to resist the flow of charges

through it. Its SI unit is ohm, represented by the Greek letter Ω . According to Ohm's law,

$$R = V/I \quad (12.6)$$

If the potential difference across the two ends of a conductor is 1 V and the current through it is 1 A, then the resistance R , of the conductor

$$\text{is } 1 \Omega. \text{ That is, } 1 \text{ ohm} = \frac{1 \text{ volt}}{1 \text{ ampere}}$$

Also from Eq. (12.5) we get

$$I = V/R \quad (12.7)$$

It is obvious from Eq. (12.7) that the current through a resistor is inversely proportional to its resistance. If the resistance is doubled the current gets halved. In many practical cases it is necessary to increase or decrease the current in an electric circuit. A component used to regulate current without changing the voltage source is called variable resistance. In an electric circuit, a device called rheostat is often used to change the resistance in the circuit. We will now study about electrical resistance of a conductor with the help of following Activity.

Activity 12.2

- Take a nichrome wire, a torch bulb, a 10 W bulb and an ammeter (0 – 5 A range), a plug key and some connecting wires.
- Set up the circuit by connecting four dry cells of 1.5 V each in series with the ammeter leaving a gap XY in the circuit, as shown in Fig. 12.4.

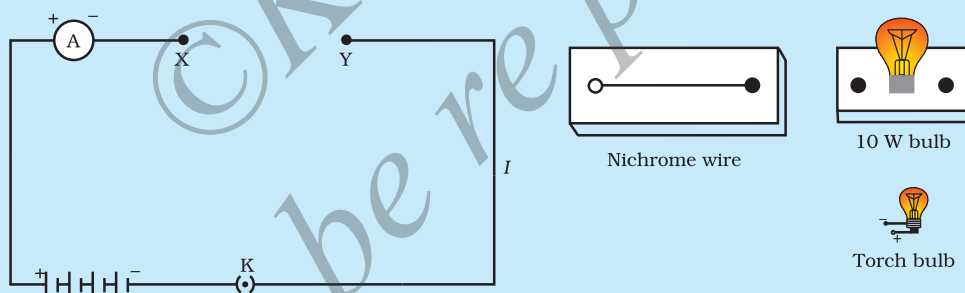

Figure 12.4

- Complete the circuit by connecting the nichrome wire in the gap XY. Plug the key. Note down the ammeter reading. Take out the key from the plug. [Note: Always take out the key from the plug after measuring the current through the circuit.]
- Replace the nichrome wire with the torch bulb in the circuit and find the current through it by measuring the reading of the ammeter.
- Now repeat the above step with the 10 W bulb in the gap XY.
- Are the ammeter readings different for different components connected in the gap XY? What do the above observations indicate?
- You may repeat this Activity by keeping any material component in the gap. Observe the ammeter readings in each case. Analyse the observations.

In this Activity we observe that the current is different for different components. Why do they differ? Certain components offer an easy path for the flow of electric current while the others resist the flow. We know

that motion of electrons in an electric circuit constitutes an electric current. The electrons, however, are not completely free to move within a conductor. They are restrained by the attraction of the atoms among which they move. Thus, motion of electrons through a conductor is retarded by its resistance. A component of a given size that offers a low resistance is a good conductor. A conductor having some appreciable resistance is called a resistor. A component of identical size that offers a higher resistance is a poor conductor. An insulator of the same size offers even higher resistance.

12.5 FACTORS ON WHICH THE RESISTANCE OF A CONDUCTOR DEPENDS

Activity 12.3

- Complete an electric circuit consisting of a cell, an ammeter, a nichrome wire of length l [say, marked (1)] and a plug key, as shown in Fig. 12.5.

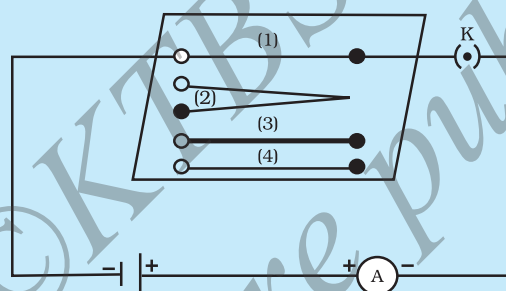

Figure 12.5 Electric circuit to study the factors on which the resistance of conducting wires depends

- Now, plug the key. Note the current in the ammeter.
- Replace the nichrome wire by another nichrome wire of same thickness but twice the length, that is $2l$ [marked (2) in the Fig. 12.5]. Note the ammeter reading.
- Now replace the wire by a thicker nichrome wire, of the same length l [marked (3)]. A thicker wire has a larger cross-sectional area. Again note down the current through the circuit.
- Instead of taking a nichrome wire, connect a copper wire [marked (4) in Fig. 12.5] in the circuit. Let the wire be of the same length and same area of cross-section as that of the first nichrome wire [marked (1)]. Note the value of the current.
- Notice the difference in the current in all cases.
- Does the current depend on the length of the conductor?
- Does the current depend on the area of cross-section of the wire used?

It is observed that the ammeter reading decreases to one-half when the length of the wire is doubled. The ammeter reading is increased when a thicker wire of the same material and of the same length is used in the circuit. A change in ammeter reading is observed when a wire of different material of the same length and the same area of cross-section is used. On applying Ohm's law [Eqs. (12.5) – (12.7)], we observe that the

resistance of the conductor depends (i) on its length, (ii) on its area of cross-section, and (iii) on the nature of its material. Precise measurements have shown that resistance of a uniform metallic conductor is directly proportional to its length (l) and inversely proportional to the area of cross-section (A). That is,

$$R \propto l \quad (12.8)$$

$$\text{and } R \propto 1/A \quad (12.9)$$

Combining Eqs. (12.8) and (12.9) we get

$$R \propto \frac{l}{A}$$

$$\text{or, } R = \rho \frac{l}{A} \quad (12.10)$$

where ρ (rho) is a constant of proportionality and is called the electrical resistivity of the material of the conductor. The SI unit of resistivity is $\Omega \text{ m}$. It is a characteristic property of the material. The metals and alloys have very low resistivity in the range of $10^{-8} \Omega \text{ m}$ to $10^{-6} \Omega \text{ m}$. They are good conductors of electricity. Insulators like rubber and glass have resistivity of the order of 10^{12} to $10^{17} \Omega \text{ m}$. Both the resistance and resistivity of a material vary with temperature.

Table 12.2 reveals that the resistivity of an alloy is generally higher than that of its constituent metals. Alloys do not oxidise (burn) readily at high temperatures. For this reason, they are commonly used in electrical heating devices, like electric iron, toasters etc. Tungsten is used almost exclusively for filaments of electric bulbs, whereas copper and aluminium are generally used for electrical transmission lines.

Table 12.2 Electrical resistivity* of some substances at 20 C

	Material	Resistivity ($\Omega \text{ m}$)
Conductors	Silver	1.60×10^{-8}
	Copper	1.62×10^{-8}
	Aluminium	2.63×10^{-8}
	Tungsten	5.20×10^{-8}
	Nickel	6.84×10^{-8}
	Iron	10.0×10^{-8}
	Chromium	12.9×10^{-8}
	Mercury	94.0×10^{-8}
	Manganese	1.84×10^{-6}
Alloys	Constantan (alloy of Cu and Ni)	49×10^{-6}
	Manganin (alloy of Cu, Mn and Ni)	44×10^{-6}
	Nichrome (alloy of Ni, Cr, Mn and Fe)	100×10^{-6}
Insulators	Glass	$10^{10} - 10^{14}$
	Hard rubber	$10^{13} - 10^{16}$
	Ebonite	$10^{15} - 10^{17}$
	Diamond	$10^{12} - 10^{13}$
	Paper (dry)	10^{12}

* You need not memorise these values. You can use these values for solving numerical problems.

Example 12.3

- (a) How much current will an electric bulb draw from a 220 V source, if the resistance of the bulb filament is 1200 Ω ? (b) How much current will an electric heater coil draw from a 220 V source, if the resistance of the heater coil is 100 Ω ?

Solution

(a) We are given $V = 220$ V; $R = 1200$ Ω .

From Eq. (12.6), we have the current $I = 220$ V / 1200 $\Omega = 0.18$ A.

(b) We are given, $V = 220$ V, $R = 100$ Ω .

From Eq. (12.6), we have the current $I = 220$ V / 100 $\Omega = 2.2$ A.

Note the difference of current drawn by an electric bulb and electric heater from the same 220 V source!

Example 12.4

The potential difference between the terminals of an electric heater is 60 V when it draws a current of 4 A from the source. What current will the heater draw if the potential difference is increased to 120 V?

Solution

We are given, potential difference $V = 60$ V, current $I = 4$ A.

According to Ohm's law, $R = \frac{V}{I} = \frac{60 \text{ V}}{4 \text{ A}} = 15 \Omega$

When the potential difference is increased to 120 V the current is given by

$$\text{current} = \frac{V}{R} = \frac{120 \text{ V}}{15 \Omega} = 8 \text{ A}$$

The current through the heater becomes 8 A.

Example 12.5

Resistance of a metal wire of length 1 m is 26 Ω at 20 C. If the diameter of the wire is 0.3 mm, what will be the resistivity of the metal at that temperature? Using Table 12.2, predict the material of the wire.

Solution

We are given the resistance R of the wire = 26 Ω , the diameter $d = 0.3$ mm = 3×10^{-4} m, and the length l of the wire = 1 m.

Therefore, from Eq. (12.10), the resistivity of the given metallic wire is

$$\rho = (RA/l) = (R\pi d^2/4l)$$

Substitution of values in this gives

$$\rho = 1.84 \times 10^{-6} \Omega \text{ m}$$

The resistivity of the metal at 20 C is 1.84×10^{-6} Ω m. From Table 12.2, we see that this is the resistivity of manganese.

Example 12.6

A wire of given material having length l and area of cross-section A has a resistance of $4\ \Omega$. What would be the resistance of another wire of the same material having length $l/2$ and area of cross-section $2A$?

Solution

For first wire

$$R_1 = \rho \frac{l}{A} = 4\ \Omega$$

Now for second wire

$$R_2 = \rho \frac{l/2}{2A} = \frac{1}{4} \rho \frac{l}{A}$$

$$R_2 = \frac{1}{4} R_1$$

$$R_2 = 1\ \Omega$$

The resistance of the new wire is $1\ \Omega$.

Q U E S T I O N S

1. On what factors does the resistance of a conductor depend?
2. Will current flow more easily through a thick wire or a thin wire of the same material, when connected to the same source? Why?
3. Let the resistance of an electrical component remains constant while the potential difference across the two ends of the component decreases to half of its former value. What change will occur in the current through it?
4. Why are coils of electric toasters and electric irons made of an alloy rather than a pure metal?
5. Use the data in Table 12.2 to answer the following –
 - (a) Which among iron and mercury is a better conductor?
 - (b) Which material is the best conductor?

12.6 RESISTANCE OF A SYSTEM OF RESISTORS

In preceding sections, we learnt about some simple electric circuits. We have noticed how the current through a conductor depends upon its resistance and the potential difference across its ends. In various electrical gadgets, we often use resistors in various combinations. We now therefore intend to see how Ohm's law can be applied to combinations of resistors.

There are two methods of joining the resistors together. Figure 12.6 shows an electric circuit in which three resistors having resistances R_1 , R_2 and R_3 , respectively, are joined end to end. Here the resistors are said to be connected in series.

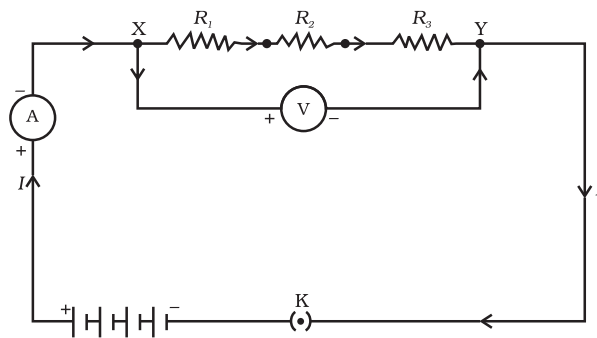

Figure 12.6 Resistors in series

Figure 12.7 shows a combination of resistors in which three resistors are connected together between points X and Y. Here, the resistors are said to be connected in parallel.

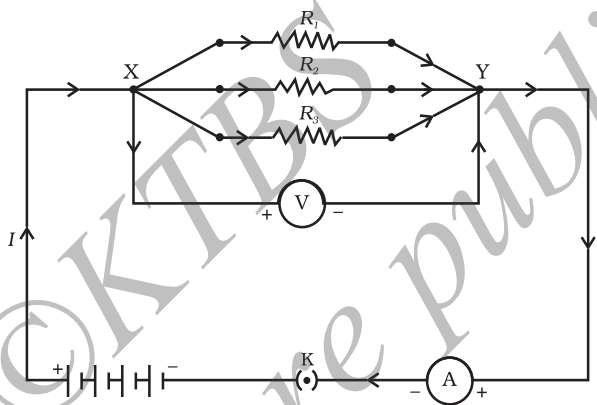

Figure 12.7 Resistors in parallel

12.6.1 Resistors in Series

What happens to the value of current when a number of resistors are connected in series in a circuit? What would be their equivalent resistance? Let us try to understand these with the help of the following activities.

Activity 12.4

- Join three resistors of different values in series. Connect them with a battery, an ammeter and a plug key, as shown in Fig. 12.6. You may use the resistors of values like $1\ \Omega$, $2\ \Omega$, $3\ \Omega$ etc., and a battery of 6 V for performing this Activity.
- Plug the key. Note the ammeter reading.
- Change the position of ammeter to anywhere in between the resistors. Note the ammeter reading each time.
- Do you find any change in the value of current through the ammeter?

You will observe that the value of the current in the ammeter is the same, independent of its position in the electric circuit. It means that in a series combination of resistors the current is the same in every part of the circuit or the same current through each resistor.

Activity 12.5

- In Activity 12.4, insert a voltmeter across the ends X and Y of the series combination of three resistors, as shown in Fig. 12.6.
- Plug the key in the circuit and note the voltmeter reading. It gives the potential difference across the series combination of resistors. Let it be V . Now measure the potential difference across the two terminals of the battery. Compare the two values.
- Take out the plug key and disconnect the voltmeter. Now insert the voltmeter across the ends X and P of the first resistor, as shown in Fig. 12.8.

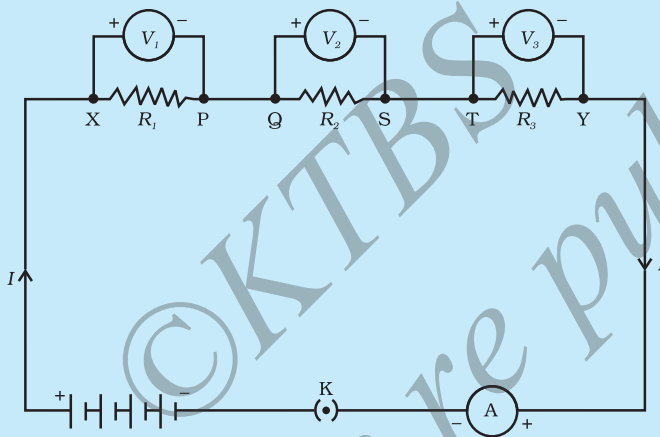

Figure 12.8

- Plug the key and measure the potential difference across the first resistor. Let it be V_1 .
- Similarly, measure the potential difference across the other two resistors, separately. Let these values be V_2 and V_3 , respectively.
- Deduce a relationship between V , V_1 , V_2 and V_3 .

You will observe that the potential difference V is equal to the sum of potential differences V_1 , V_2 , and V_3 . That is the total potential difference across a combination of resistors in series is equal to the sum of potential difference across the individual resistors. That is,

$$V = V_1 + V_2 + V_3 \quad (12.11)$$

In the electric circuit shown in Fig. 12.8, let I be the current through the circuit. The current through each resistor is also I . It is possible to replace the three resistors joined in series by an equivalent single resistor of resistance R , such that the potential difference V across it, and the current I through the circuit remains the same. Applying the Ohm's law to the entire circuit, we have

$$V = IR \quad (12.12)$$

On applying Ohm's law to the three resistors separately, we further have

$$V_1 = IR_1 \quad [12.13(a)]$$

$$V_2 = IR_2 \quad [12.13(b)]$$

and $V_3 = IR_3 \quad [12.13(c)]$

From Eq. (12.11),

$$IR = IR_1 + IR_2 + IR_3$$

or

$$R_s = R_1 + R_2 + R_3 \quad (12.14)$$

We can conclude that when several resistors are joined in series, the resistance of the combination R_s equals the sum of their individual resistances, R_1, R_2, R_3 , and is thus greater than any individual resistance.

Example 12.7

An electric lamp, whose resistance is 20Ω , and a conductor of 4Ω resistance are connected to a 6 V battery (Fig. 12.9). Calculate (a) the total resistance of the circuit, (b) the current through the circuit, and (c) the potential difference across the electric lamp and conductor.

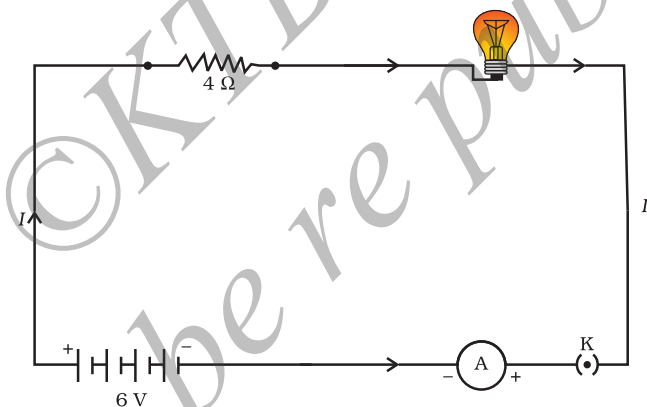

Figure 12.9 An electric lamp connected in series with a resistor of 4Ω to a 6 V battery

Solution

The resistance of electric lamp, $R_1 = 20 \Omega$,

The resistance of the conductor connected in series, $R_2 = 4 \Omega$.

Then the total resistance in the circuit

$$R = R_1 + R_2$$

$$R_s = 20 \Omega + 4 \Omega = 24 \Omega.$$

The total potential difference across the two terminals of the battery $V = 6 \text{ V}$.

Now by Ohm's law, the current through the circuit is given by

$$\begin{aligned} I &= V/R_s \\ &= 6 \text{ V}/24 \Omega \\ &= 0.25 \text{ A}. \end{aligned}$$

Applying Ohm's law to the electric lamp and conductor separately, we get potential difference across the electric lamp,

$$\begin{aligned} V_1 &= 20 \Omega \times 0.25 \text{ A} \\ &= 5 \text{ V}; \end{aligned}$$

and,

$$\begin{aligned} \text{that across the conductor, } V_2 &= 4 \Omega \times 0.25 \text{ A} \\ &= 1 \text{ V}. \end{aligned}$$

Suppose that we like to replace the series combination of electric lamp and conductor by a single and equivalent resistor. Its resistance must be such that a potential difference of 6 V across the battery terminals will cause a current of 0.25 A in the circuit. The resistance R of this equivalent resistor would be

$$\begin{aligned} R &= V/I \\ &= 6 \text{ V} / 0.25 \text{ A} \\ &= 24 \Omega. \end{aligned}$$

This is the total resistance of the series circuit; it is equal to the sum of the two resistances.

Q U E S T I O N S

1. Draw a schematic diagram of a circuit consisting of a battery of three cells of 2 V each, a 5 Ω resistor, an 8 Ω resistor, and a 12 Ω resistor, and a plug key, all connected in series.
2. Redraw the circuit of Question 1, putting in an ammeter to measure the current through the resistors and a voltmeter to measure the potential difference across the 12 Ω resistor. What would be the readings in the ammeter and the voltmeter?

12.6.2 Resistors in Parallel

Now, let us consider the arrangement of three resistors joined in parallel with a combination of cells (or a battery), as shown in Fig. 12.7.

Activity 12.6

- Make a parallel combination, XY, of three resistors having resistances R_1 , R_2 , and R_3 , respectively. Connect it with a battery, a plug key and an ammeter, as shown in Fig. 12.10. Also connect a voltmeter in parallel with the combination of resistors.
- Plug the key and note the ammeter reading. Let the current be I . Also take the voltmeter reading. It gives the potential difference V , across the combination. The potential difference across each resistor is also V . This can be checked by connecting the voltmeter across each individual resistor (see Fig. 12.11).

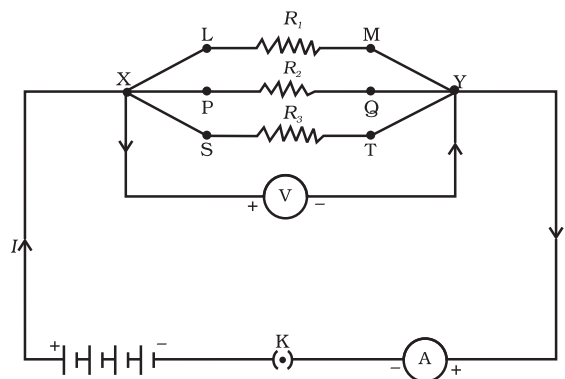

Figure 12.10

- Take out the plug from the key. Remove the ammeter and voltmeter from the circuit. Insert the ammeter in series with the resistor R_1 , as shown in Fig. 12.11. Note the ammeter reading, I_1 .

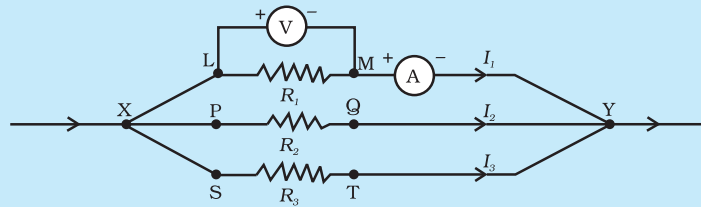

Figure 12.11

- Similarly, measure the currents through R_2 and R_3 . Let these be I_2 and I_3 , respectively. What is the relationship between I , I_1 , I_2 and I_3 ?

It is observed that the total current I , is equal to the sum of the separate currents through each branch of the combination.

$$I = I_1 + I_2 + I_3 \quad (12.15)$$

Let R_p be the equivalent resistance of the parallel combination of resistors. By applying Ohm's law to the parallel combination of resistors, we have

$$I = V/R_p \quad (12.16)$$

On applying Ohm's law to each resistor, we have

$$I_1 = V/R_1; \quad I_2 = V/R_2; \quad \text{and} \quad I_3 = V/R_3 \quad (12.17)$$

From Eqs. (12.15) to (12.17), we have

$$V/R_p = V/R_1 + V/R_2 + V/R_3$$

or

$$1/R_p = 1/R_1 + 1/R_2 + 1/R_3 \quad (12.18)$$

Thus, we may conclude that the reciprocal of the equivalent resistance of a group of resistances joined in parallel is equal to the sum of the reciprocals of the individual resistances.

Example 12.8

In the circuit diagram given in Fig. 12.10, suppose the resistors R_1 , R_2 and R_3 have the values 5Ω , 10Ω , 30Ω , respectively, which have been connected to a battery of 12 V . Calculate (a) the current through each resistor, (b) the total current in the circuit, and (c) the total circuit resistance.

Solution

$R_1 = 5 \Omega$, $R_2 = 10 \Omega$, and $R_3 = 30 \Omega$.

Potential difference across the battery, $V = 12 \text{ V}$.

This is also the potential difference across each of the individual resistor; therefore, to calculate the current in the resistors, we use Ohm's law.

$$\begin{aligned} \text{The current } I_1, \text{ through } R_1 &= V/R_1 \\ I_1 &= 12 \text{ V}/5 \Omega = 2.4 \text{ A.} \end{aligned}$$

The current I_2 , through $R_2 = V/R_2$
 $I_2 = 12 \text{ V}/10 \ \Omega = 1.2 \text{ A}.$

The current I_3 , through $R_3 = V/R_3$
 $I_3 = 12 \text{ V}/30 \ \Omega = 0.4 \text{ A}.$

The total current in the circuit,

$$\begin{aligned} I &= I_1 + I_2 + I_3 \\ &= (2.4 + 1.2 + 0.4) \text{ A} \\ &= 4 \text{ A} \end{aligned}$$

The total resistance R_p , is given by [Eq. (12.18)]

$$\frac{1}{R_p} = \frac{1}{5} + \frac{1}{10} + \frac{1}{30} = \frac{1}{3}$$

Thus, $R_p = 3 \ \Omega.$

Example 12.9

If in Fig. 12.12, $R_1 = 10 \ \Omega$, $R_2 = 40 \ \Omega$, $R_3 = 30 \ \Omega$, $R_4 = 20 \ \Omega$, $R_5 = 60 \ \Omega$, and a 12 V battery is connected to the arrangement. Calculate (a) the total resistance in the circuit, and (b) the total current flowing in the circuit.

Solution

Suppose we replace the parallel resistors R_1 and R_2 by an equivalent resistor of resistance, R' . Similarly we replace the parallel resistors R_3 , R_4 and R_5 by an equivalent single resistor of resistance R'' . Then using Eq. (12.18), we have $1/R' = 1/10 + 1/40 = 5/40$; that is $R' = 8 \ \Omega$.

Similarly, $1/R'' = 1/30 + 1/20 + 1/60 = 6/60$;
 that is, $R'' = 10 \ \Omega$.

Thus, the total resistance, $R = R' + R'' = 18 \ \Omega$.

To calculate the current, we use Ohm's law, and get

$$I = V/R = 12 \text{ V}/18 \ \Omega = 0.67 \text{ A}.$$

We have seen that in a series circuit the current is constant throughout the electric circuit. Thus it is obviously impracticable to connect an electric bulb and an electric heater in series, because they need currents of widely different values to operate properly (see Example 12.3). Another major disadvantage of a series circuit is that when one component fails the circuit is broken and none of the components works. If you have used 'fairy lights' to decorate buildings on festivals, on marriage celebrations etc., you might have seen the electrician spending lot of time in trouble-locating and replacing the 'dead' bulb – each has to be tested to find which has fused or gone. On the other hand, a parallel circuit divides the current through the electrical gadgets. The total resistance in a parallel circuit is decreased as per Eq. (12.18). This is helpful particularly when each gadget has different resistance and requires different current to operate properly.

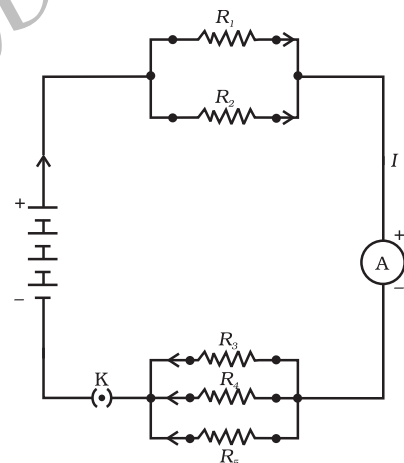

Figure 12.12
 An electric circuit showing the combination of series and parallel resistors

Q U E S T I O N S

1. Judge the equivalent resistance when the following are connected in parallel – (a) $1\ \Omega$ and $10^6\ \Omega$, (b) $1\ \Omega$ and $10^3\ \Omega$, and $10^6\ \Omega$.
2. An electric lamp of $100\ \Omega$, a toaster of resistance $50\ \Omega$, and a water filter of resistance $500\ \Omega$ are connected in parallel to a $220\ \text{V}$ source. What is the resistance of an electric iron connected to the same source that takes as much current as all three appliances, and what is the current through it?
3. What are the advantages of connecting electrical devices in parallel with the battery instead of connecting them in series?
4. How can three resistors of resistances $2\ \Omega$, $3\ \Omega$, and $6\ \Omega$ be connected to give a total resistance of (a) $4\ \Omega$, (b) $1\ \Omega$?
5. What is (a) the highest, (b) the lowest total resistance that can be secured by combinations of four coils of resistance $4\ \Omega$, $8\ \Omega$, $12\ \Omega$, $24\ \Omega$?

12.7 HEATING EFFECT OF ELECTRIC CURRENT

We know that a battery or a cell is a source of electrical energy. The chemical reaction within the cell generates the potential difference between its two terminals that sets the electrons in motion to flow the current through a resistor or a system of resistors connected to the battery. We have also seen, in Section 12.2, that to maintain the current, the source has to keep expending its energy. Where does this energy go? A part of the source energy in maintaining the current may be consumed into useful work (like in rotating the blades of an electric fan). Rest of the source energy may be expended in heat to raise the temperature of gadget. We often observe this in our everyday life. For example, an electric fan becomes warm if used continuously for longer time etc. On the other hand, if the electric circuit is purely resistive, that is, a configuration of resistors only connected to a battery; the source energy continually gets dissipated entirely in the form of heat. This is known as the heating effect of electric current. This effect is utilised in devices such as electric heater, electric iron etc.

Consider a current I flowing through a resistor of resistance R . Let the potential difference across it be V (Fig. 12.13). Let t be the time during which a charge Q flows across. The work done in moving the charge Q through a potential difference V is VQ . Therefore, the source must supply energy equal to VQ in time t . Hence the power input to the circuit by the source is

$$P = V \frac{Q}{t} = VI \quad (12.19)$$

Or the energy supplied to the circuit by the source in time t is $P \times t$, that is, $VI t$. What happens to this energy expended by the source? This energy gets dissipated in the resistor as heat. Thus for a steady current I , the amount of heat H produced in time t is

$$H = VI t \quad (12.20)$$

Applying Ohm's law [Eq. (12.5)], we get

$$H = I^2 R t \quad (12.21)$$

This is known as Joule's law of heating. The law implies that heat produced in a resistor is (i) directly proportional to the square of current for a given resistance, (ii) directly proportional to resistance for a given current, and (iii) directly proportional to the time for which the current flows through the resistor. In practical situations, when an electric appliance is connected to a known voltage source, Eq. (12.21) is used after calculating the current through it, using the relation $I = V/R$.

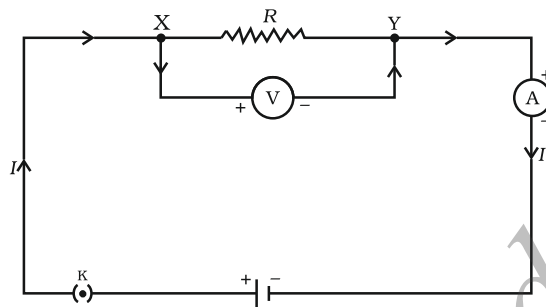

Figure 12.13
A steady current in a purely resistive electric circuit

Example 12.10

An electric iron consumes energy at a rate of 840 W when heating is at the maximum rate and 360 W when the heating is at the minimum. The voltage is 220 V. What are the current and the resistance in each case?

Solution

From Eq. (12.19), we know that the power input is

$$P = VI$$

Thus the current $I = P/V$

- (a) When heating is at the maximum rate,
 $I = 840 \text{ W}/220 \text{ V} = 3.82 \text{ A}$;
 and the resistance of the electric iron is
 $R = V/I = 220 \text{ V}/3.82 \text{ A} = 57.60 \Omega$
- (b) When heating is at the minimum rate,
 $I = 360 \text{ W}/220 \text{ V} = 1.64 \text{ A}$;
 and the resistance of the electric iron is
 $R = V/I = 220 \text{ V}/1.64 \text{ A} = 134.15 \Omega$

Example 12.11

100 J of heat is produced each second in a 4Ω resistance. Find the potential difference across the resistor.

Solution

$$H = 100 \text{ J}, R = 4 \Omega, t = 1 \text{ s}, V = ?$$

From Eq. (12.21) we have the current through the resistor as

$$\begin{aligned} I &= \sqrt{H/Rt} \\ &= \sqrt{[100 \text{ J}/(4 \Omega \times 1 \text{ s})]} \\ &= 5 \text{ A} \end{aligned}$$

Thus the potential difference across the resistor, V [from Eq. (12.5)] is

$$\begin{aligned} V &= IR \\ &= 5 \text{ A} \times 4 \Omega \\ &= 20 \text{ V} \end{aligned}$$

Q U E S T I O N S

1. Why does the cord of an electric heater not glow while the heating element does?
2. Compute the heat generated while transferring 96000 coulomb of charge in one hour through a potential difference of 50 V.
3. An electric iron of resistance $20\ \Omega$ takes a current of 5 A. Calculate the heat developed in 30 s.

12.7.1 Practical Applications of Heating Effect of Electric Current

The generation of heat in a conductor is an inevitable consequence of electric current. In many cases, it is undesirable as it converts useful electrical energy into heat. In electric circuits, the unavoidable heating can increase the temperature of the components and alter their properties. However, heating effect of electric current has many useful applications. The electric laundry iron, electric toaster, electric oven, electric kettle and electric heater are some of the familiar devices based on Joule's heating.

The electric heating is also used to produce light, as in an electric bulb. Here, the filament must retain as much of the heat generated as is possible, so that it gets very hot and emits light. It must not melt at such high temperature. A strong metal with high melting point such as tungsten (melting point 3380 C) is used for making bulb filaments. The filament should be thermally isolated as much as possible, using insulating support, etc. The bulbs are usually filled with chemically inactive nitrogen and argon gases to prolong the life of filament. Most of the power consumed by the filament appears as heat, but a small part of it is in the form of light radiated.

Another common application of Joule's heating is the fuse used in electric circuits. It protects circuits and appliances by stopping the flow of any unduly high electric current. The fuse is placed in series with the device. It consists of a piece of wire made of a metal or an alloy of appropriate melting point, for example aluminium, copper, iron, lead etc. If a current larger than the specified value flows through the circuit, the temperature of the fuse wire increases. This melts the fuse wire and breaks the circuit. The fuse wire is usually encased in a cartridge of porcelain or similar material with metal ends. The fuses used for domestic purposes are rated as 1 A, 2 A, 3 A, 5 A, 10 A, etc. For an electric iron which consumes 1 kW electric power when operated at 220 V, a current of $(1000/220)\text{ A}$, that is, 4.54 A will flow in the circuit. In this case, a 5 A fuse must be used.

12.8 ELECTRIC POWER

You have studied in your earlier Class that the rate of doing work is power. This is also the rate of consumption of energy.

Equation (12.21) gives the rate at which electric energy is dissipated or consumed in an electric circuit. This is also termed as electric power. The power P is given by

$$\begin{aligned} P &= VI \\ \text{Or } P &= I^2R = V^2/R \end{aligned} \quad (12.22)$$

The SI unit of electric power is watt (W). It is the power consumed by a device that carries 1 A of current when operated at a potential difference of 1 V. Thus,

$$1 \text{ W} = 1 \text{ volt} \times 1 \text{ ampere} = 1 \text{ V A} \quad (12.23)$$

The unit 'watt' is very small. Therefore, in actual practice we use a much larger unit called 'kilowatt'. It is equal to 1000 watts. Since electrical energy is the product of power and time, the unit of electric energy is, therefore, watt hour (W h). One watt hour is the energy consumed when 1 watt of power is used for 1 hour. The commercial unit of electric energy is kilowatt hour (kW h), commonly known as 'unit'.

$$\begin{aligned} 1 \text{ kW h} &= 1000 \text{ watt} \times 3600 \text{ second} \\ &= 3.6 \times 10^6 \text{ watt second} \\ &= 3.6 \times 10^6 \text{ joule (J)} \end{aligned}$$

More to Know!

Many people think that electrons are consumed in an electric circuit. This is wrong! We pay the electricity board or electric company to provide energy to move electrons through the electric gadgets like electric bulb, fan and engines. We pay for the energy that we use.

Example 12.12

An electric bulb is connected to a 220 V generator. The current is 0.50 A. What is the power of the bulb?

Solution

$$\begin{aligned} P &= VI \\ &= 220 \text{ V} \times 0.50 \text{ A} \\ &= 110 \text{ J/s} \\ &= 110 \text{ W.} \end{aligned}$$

Example 12.13

An electric refrigerator rated 400 W operates 8 hour/day. What is the cost of the energy to operate it for 30 days at Rs 3.00 per kW h?

Solution

The total energy consumed by the refrigerator in 30 days would be
 $400 \text{ W} \times 8.0 \text{ hour/day} \times 30 \text{ days} = 96000 \text{ W h}$
 $= 96 \text{ kW h}$

Thus the cost of energy to operate the refrigerator for 30 days is
 $96 \text{ kW h} \times \text{Rs } 3.00 \text{ per kW h} = \text{Rs } 288.00$

Q U E S T I O N S

1. What determines the rate at which energy is delivered by a current?
2. An electric motor takes 5 A from a 220 V line. Determine the power of the motor and the energy consumed in 2 h.

What you have learnt

- A stream of electrons moving through a conductor constitutes an electric current. Conventionally, the direction of current is taken opposite to the direction of flow of electrons.
- The SI unit of electric current is ampere.
- To set the electrons in motion in an electric circuit, we use a cell or a battery. A cell generates a potential difference across its terminals. It is measured in volts (V).
- Resistance is a property that resists the flow of electrons in a conductor. It controls the magnitude of the current. The SI unit of resistance is ohm (Ω).
- Ohm's law: The potential difference across the ends of a resistor is directly proportional to the current through it, provided its temperature remains the same.
- The resistance of a conductor depends directly on its length, inversely on its area of cross-section, and also on the material of the conductor.
- The equivalent resistance of several resistors in series is equal to the sum of their individual resistances.
- A set of resistors connected in parallel has an equivalent resistance R_p given by
$$\frac{1}{R_p} = \frac{1}{R_1} + \frac{1}{R_2} + \frac{1}{R_3} + \dots$$
- The electrical energy dissipated in a resistor is given by
$$W = V \times I \times t$$
- The unit of power is watt (W). One watt of power is consumed when 1 A of current flows at a potential difference of 1 V.
- The commercial unit of electrical energy is kilowatt hour (kWh).
$$1 \text{ kW h} = 3,600,000 \text{ J} = 3.6 \times 10^6 \text{ J}.$$

E X E R C I S E S

1. A piece of wire of resistance R is cut into five equal parts. These parts are then connected in parallel. If the equivalent resistance of this combination is R' , then the ratio R/R' is –
 - (a) $1/25$
 - (b) $1/5$
 - (c) 5
 - (d) 25
2. Which of the following terms does not represent electrical power in a circuit?
 - (a) I^2R
 - (b) IR^2
 - (c) VI
 - (d) V^2/R
3. An electric bulb is rated 220 V and 100 W. When it is operated on 110 V, the power consumed will be –
 - (a) 100 W
 - (b) 75 W
 - (c) 50 W
 - (d) 25 W
4. Two conducting wires of the same material and of equal lengths and equal diameters are first connected in series and then parallel in a circuit across the same potential difference. The ratio of heat produced in series and parallel combinations would be –
 - (a) 1:2
 - (b) 2:1
 - (c) 1:4
 - (d) 4:1
5. How is a voltmeter connected in the circuit to measure the potential difference between two points?
6. A copper wire has diameter 0.5 mm and resistivity of $1.6 \times 10^{-8} \Omega \text{ m}$. What will be the length of this wire to make its resistance 10Ω ? How much does the resistance change if the diameter is doubled?
7. The values of current I flowing in a given resistor for the corresponding values of potential difference V across the resistor are given below –

I (amperes)	0.5	1.0	2.0	3.0	4.0
V (volts)	1.6	3.4	6.7	10.2	13.2

 Plot a graph between V and I and calculate the resistance of that resistor.
8. When a 12 V battery is connected across an unknown resistor, there is a current of 2.5 mA in the circuit. Find the value of the resistance of the resistor.
9. A battery of 9 V is connected in series with resistors of 0.2Ω , 0.3Ω , 0.4Ω , 0.5Ω and 12Ω , respectively. How much current would flow through the 12Ω resistor?
10. How many 176Ω resistors (in parallel) are required to carry 5 A on a 220 V line?
11. Show how you would connect three resistors, each of resistance 6Ω , so that the combination has a resistance of (i) 9Ω , (ii) 4Ω .
12. Several electric bulbs designed to be used on a 220 V electric supply line, are rated 10 W. How many lamps can be connected in parallel with each other across the two wires of 220 V line if the maximum allowable current is 5 A?
13. A hot plate of an electric oven connected to a 220 V line has two resistance coils A and B, each of 24Ω resistance, which may be used separately, in series, or in parallel. What are the currents in the three cases?
14. Compare the power used in the 2Ω resistor in each of the following circuits: (i) a 6 V battery in series with 1Ω and 2Ω resistors, and (ii) a 4 V battery in parallel with 12Ω and 2Ω resistors.

15. Two lamps, one rated 100 W at 220 V, and the other 60 W at 220 V, are connected in parallel to electric mains supply. What current is drawn from the line if the supply voltage is 220 V?
16. Which uses more energy, a 250 W TV set in 1 hr, or a 1200 W toaster in 10 minutes?
17. An electric heater of resistance 8Ω draws 15 A from the service mains 2 hours. Calculate the rate at which heat is developed in the heater.
18. Explain the following.
- Why is the tungsten used almost exclusively for filament of electric lamps?
 - Why are the conductors of electric heating devices, such as bread-toasters and electric irons, made of an alloy rather than a pure metal?
 - Why is the series arrangement not used for domestic circuits?
 - How does the resistance of a wire vary with its area of cross-section?
 - Why are copper and aluminium wires usually employed for electricity transmission?

CHAPTER 13

Magnetic Effects of Electric Current

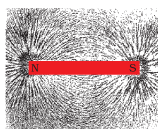

In the previous Chapter on 'Electricity' we learnt about the heating effects of electric current. What could be the other effects of electric current? We know that an electric current-carrying wire behaves like a magnet. Let us perform the following Activity to reinforce it.

Activity 13.1

- Take a straight thick copper wire and place it between the points X and Y in an electric circuit, as shown in Fig. 13.1. The wire XY is kept perpendicular to the plane of paper.
- Horizontally place a small compass near to this copper wire. See the position of its needle.
- Pass the current through the circuit by inserting the key into the plug.
- Observe the change in the position of the compass needle.

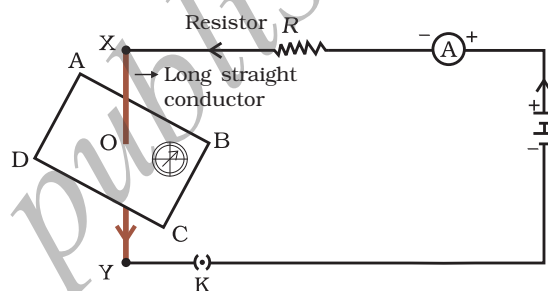
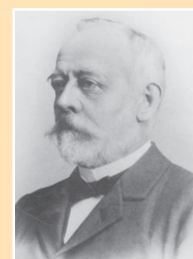

Figure 13.1
Compass needle is deflected on passing an electric current through a metallic conductor

We see that the needle is deflected. What does it mean? It means that the electric current through the copper wire has produced a magnetic effect. Thus we can say that electricity and magnetism are linked to each other. Then, what about the reverse possibility of an electric effect of moving magnets? In this Chapter we will study magnetic fields and such electromagnetic effects. We shall also study about electromagnets and electric motors which involve the magnetic effect of electric current, and electric generators which involve the electric effect of moving magnets.

Hans Christian Oersted (1777–1851)

Hans Christian Oersted, one of the leading scientists of the 19th century, played a crucial role in understanding *electromagnetism*. In 1820 he accidentally discovered that a compass needle got deflected when an electric current passed through a metallic wire placed nearby. Through this observation Oersted showed that electricity and magnetism were related phenomena. His research later created technologies such as the radio, television and fiber optics. The unit of magnetic field strength is named the oersted in his honor.



13.1 MAGNETIC FIELD AND FIELD LINES

We are familiar with the fact that a compass needle gets deflected when brought near a bar magnet. A compass needle is, in fact, a small bar magnet. The ends of the compass needle point approximately towards north and south directions. The end pointing towards north is called *north seeking* or north pole. The other end that points towards south is called *south seeking* or south pole. Through various activities we have observed that like poles repel, while unlike poles of magnets attract each other.

Q U E S T I O N

1. Why does a compass needle get deflected when brought near a bar magnet?

Activity 13.2

- Fix a sheet of white paper on a drawing board using some adhesive material.
- Place a bar magnet in the centre of it.
- Sprinkle some iron filings uniformly around the bar magnet (Fig. 13.2). A salt-sprinkler may be used for this purpose.
- Now tap the board gently.
- What do you observe?

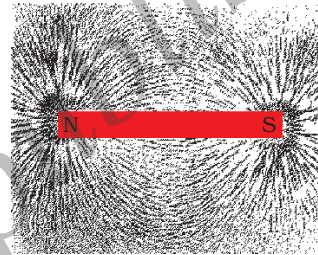

Figure 13.2

Iron filings near the bar magnet align themselves along the field lines.

The iron filings arrange themselves in a pattern as shown Fig. 13.2. Why do the iron filings arrange in such a pattern? What does this pattern demonstrate? The magnet exerts its influence in the region surrounding it. Therefore the iron filings experience a force. The force thus exerted makes iron filings to arrange in a pattern. The region surrounding a magnet, in which the force of the magnet can be detected, is said to have a magnetic field. The lines along which the iron filings align themselves represent magnetic field lines.

Are there other ways of obtaining magnetic field lines around a bar magnet? Yes, you can yourself draw the field lines of a bar magnet.

Activity 13.3

- Take a small compass and a bar magnet.
- Place the magnet on a sheet of white paper fixed on a drawing board, using some adhesive material.
- Mark the boundary of the magnet.
- Place the compass near the north pole of the magnet. How does it behave? The south pole of the needle points towards the north pole of the magnet. The north pole of the compass is directed away from the north pole of the magnet.

- Mark the position of two ends of the needle.
- Now move the needle to a new position such that its south pole occupies the position previously occupied by its north pole.
- In this way, proceed step by step till you reach the south pole of the magnet as shown in Fig. 13.3.
- Join the points marked on the paper by a smooth curve. This curve represents a field line.
- Repeat the above procedure and draw as many lines as you can. You will get a pattern shown in Fig. 13.4. These lines represent the magnetic field around the magnet. These are known as magnetic field lines.
- Observe the deflection in the compass needle as you move it along a field line. The deflection increases as the needle is moved towards the poles.

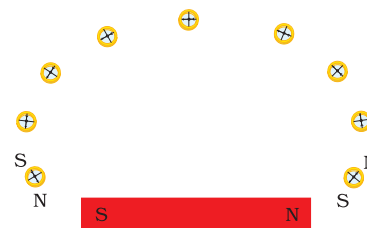

Figure 13.3
Drawing a magnetic field line with the help of a compass needle

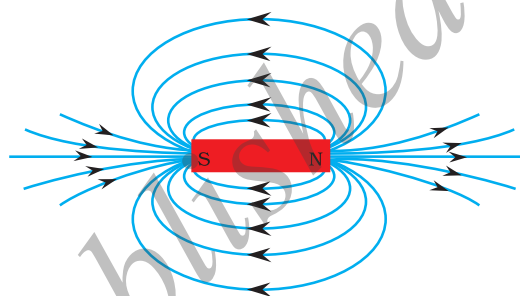

Figure 13.4
Field lines around a bar magnet

Magnetic field is a quantity that has both direction and magnitude. The direction of the magnetic field is taken to be the direction in which a north pole of the compass needle moves inside it. Therefore it is taken by convention that the field lines emerge from north pole and merge at the south pole (note the arrows marked on the field lines in Fig. 13.4). Inside the magnet, the direction of field lines is from its south pole to its north pole. Thus the magnetic field lines are closed curves.

The relative strength of the magnetic field is shown by the degree of closeness of the field lines. The field is stronger, that is, the force acting on the pole of another magnet placed is greater where the field lines are crowded (see Fig. 13.4).

No two field-lines are found to cross each other. If they did, it would mean that at the point of intersection, the compass needle would point towards two directions, which is not possible.

13.2 MAGNETIC FIELD DUE TO A CURRENT-CARRYING CONDUCTOR

In Activity 13.1, we have seen that an electric current through a metallic conductor produces a magnetic field around it. In order to find the direction of the field produced let us repeat the activity in the following way –

Magnetic Effects of Electric Current

Activity 13.4

- Take a long straight copper wire, two or three cells of 1.5 V each, and a plug key. Connect all of them in series as shown in Fig. 13.5 (a).
- Place the straight wire parallel to and over a compass needle.
- Plug the key in the circuit.
- Observe the direction of deflection of the north pole of the needle. If the current flows from north to south, as shown in Fig. 13.5 (a), the north pole of the compass needle would move towards the east.
- Replace the cell connections in the circuit as shown in Fig. 13.5 (b). This would result in the change of the direction of current through the copper wire, that is, from south to north.
- Observe the change in the direction of deflection of the needle. You will see that now the needle moves in opposite direction, that is, towards the west [Fig. 13.5 (b)]. It means that the direction of magnetic field produced by the electric current is also reversed.

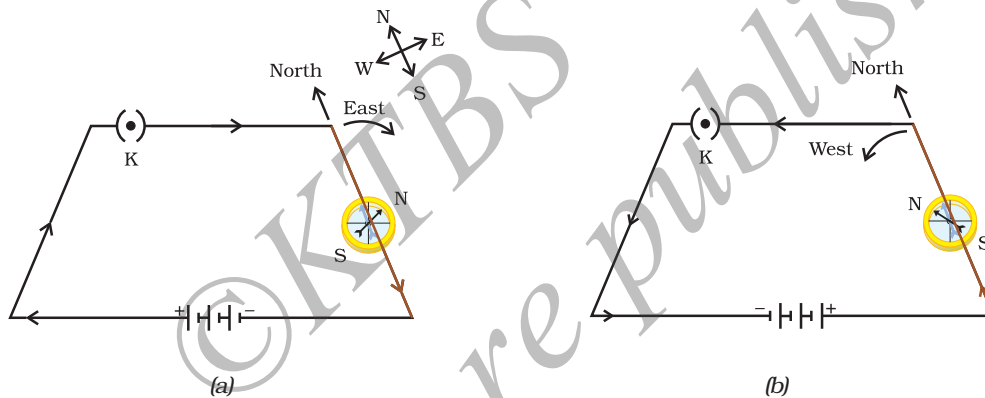

Figure 13.5 A simple electric circuit in which a straight copper wire is placed parallel to and over a compass needle. The deflection in the needle becomes opposite when the direction of the current is reversed.

13.2.1 Magnetic Field due to a Current through a Straight Conductor

What determines the pattern of the magnetic field generated by a current through a conductor? Does the pattern depend on the shape of the conductor? We shall investigate this with an activity.

We shall first consider the pattern of the magnetic field around a straight conductor carrying current.

Activity 13.5

- Take a battery (12 V), a variable resistance (or a rheostat), an ammeter (0–5 A), a plug key, connecting wires and a long straight thick copper wire.
- Insert the thick wire through the centre, normal to the plane of a rectangular cardboard. Take care that the cardboard is fixed and does not slide up or down.

- Connect the copper wire vertically between the points X and Y, as shown in Fig. 13.6 (a), in series with the battery, a plug and key.
- Sprinkle some iron filings uniformly on the cardboard. (You may use a salt sprinkler for this purpose.)
- Keep the variable of the rheostat at a fixed position and note the current through the ammeter.
- Close the key so that a current flows through the wire. Ensure that the copper wire placed between the points X and Y remains vertically straight.
- Gently tap the cardboard a few times. Observe the pattern of the iron filings. You would find that the iron filings align themselves showing a pattern of concentric circles around the copper wire (Fig. 13.6).
- What do these concentric circles represent? They represent the magnetic field lines.
- How can the direction of the magnetic field be found? Place a compass at a point (say P) over a circle. Observe the direction of the needle. The direction of the north pole of the compass needle would give the direction of the field lines produced by the electric current through the straight wire at point P. Show the direction by an arrow.
- Does the direction of magnetic field lines get reversed if the direction of current through the straight copper wire is reversed? Check it.

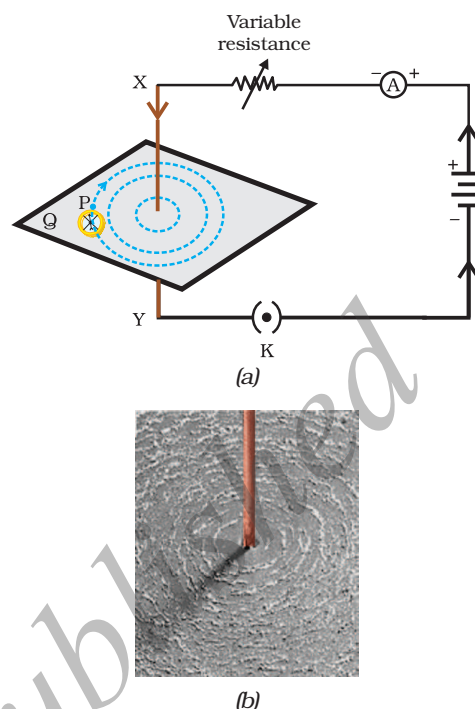

Figure 13.6
 (a) A pattern of concentric circles indicating the field lines of a magnetic field around a straight conducting wire. The arrows in the circles show the direction of the field lines.
 (b) A close up of the pattern obtained.

What happens to the deflection of the compass needle placed at a given point if the current in the copper wire is changed? To see this, vary the current in the wire. We find that the deflection in the needle also changes. In fact, if the current is increased, the deflection also increases. It indicates that the magnitude of the magnetic field produced at a given point increases as the current through the wire increases.

What happens to the deflection of the needle if the compass is moved away from the copper wire but the current through the wire remains the same? To see this, now place the compass at a farther point from the conducting wire (say at point Q). What change do you observe? We see that the deflection in the needle decreases. Thus the magnetic field produced by a given current in the conductor decreases as the distance from it increases. From Fig. 13.6, it can be noticed that the concentric circles representing the magnetic field around a current-carrying straight wire become larger and larger as we move away from it.

13.2.2 Right-Hand Thumb Rule

A convenient way of finding the direction of magnetic field associated with a current-carrying conductor is given in Fig. 13.7.

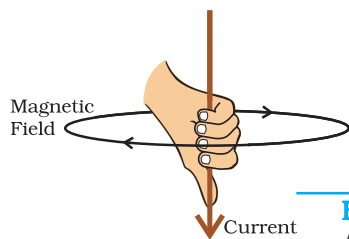

Figure 13.7
Right-hand thumb rule

Imagine that you are holding a current-carrying straight conductor in your right hand such that the thumb points towards the direction of current. Then your fingers will wrap around the conductor in the direction of the field lines of the magnetic field, as shown in Fig. 13.7. This is known as the right-hand thumb rule*.

Example 13.1

A current through a horizontal power line flows in east to west direction. What is the direction of magnetic field at a point directly below it and at a point directly above it?

Solution

The current is in the east-west direction. Applying the right-hand thumb rule, we get that the magnetic field (at any point below or above the wire) turns clockwise in a plane perpendicular to the wire, when viewed from the east end, and anti-clockwise, when viewed from the west end.

Q U E S T I O N S

1. Draw magnetic field lines around a bar magnet.
2. List the properties of magnetic field lines.
3. Why don't two magnetic field lines intersect each other?

13.2.3 Magnetic Field due to a Current through a Circular Loop

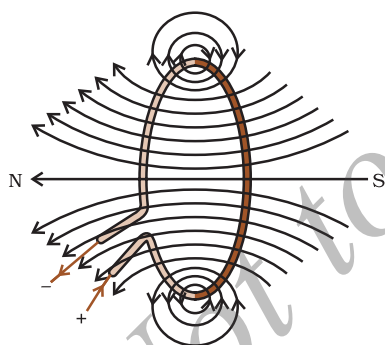

Figure 13.8
Magnetic field lines of the field produced by a current-carrying circular loop

We have so far observed the pattern of the magnetic field lines produced around a current-carrying straight wire. Suppose this straight wire is bent in the form of a circular loop and a current is passed through it. How would the magnetic field lines look like? We know that the magnetic field produced by a current-carrying straight wire depends inversely on the distance from it. Similarly at every point of a current-carrying circular loop, the concentric circles representing the magnetic field around it would become larger and larger as we move away from the wire (Fig. 13.8). By the time we reach at the centre of the circular loop, the arcs of these *big* circles would appear as straight lines. Every point on the wire carrying current would give rise to the magnetic field appearing as straight lines at the center of the loop. By applying the right hand rule, it is easy to check that every section of the wire contributes to the magnetic field lines in the same direction within the loop.

* This rule is also called Maxwell's corkscrew rule. If we consider ourselves driving a corkscrew in the direction of the current, then the direction of the rotation of corkscrew is the direction of the magnetic field.

We know that the magnetic field produced by a current-carrying wire at a given point depends directly on the current passing through it. Therefore, if there is a circular coil having n turns, the field produced is n times as large as that produced by a single turn. This is because the current in each circular turn has the same direction, and the field due to each turn then just adds up.

Activity 13.6

- Take a rectangular cardboard having two holes. Insert a circular coil having large number of turns through them, normal to the plane of the cardboard.
- Connect the ends of the coil in series with a battery, a key and a rheostat, as shown in Fig. 13.9.
- Sprinkle iron filings uniformly on the cardboard.
- Plug the key.
- Tap the cardboard gently a few times. Note the pattern of the iron filings that emerges on the cardboard.

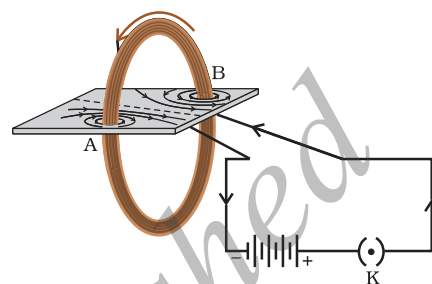

Figure 13.9
Magnetic field produced by a current-carrying circular coil.

13.2.4 Magnetic Field due to a Current in a Solenoid

A coil of many circular turns of insulated copper wire wrapped closely in the shape of a cylinder is called a solenoid. The pattern of the magnetic field lines around a current-carrying solenoid is shown in Fig. 13.10. Compare the pattern of the field with the magnetic field around a bar magnet (Fig. 13.4). Do they look similar? Yes, they are similar. In fact, one end of the solenoid behaves as a magnetic north pole, while the other behaves as the south pole. The field lines inside the solenoid are in the form of parallel straight lines. This indicates that the magnetic field is the same at all points inside the solenoid. That is, the field is uniform inside the solenoid.

A strong magnetic field produced inside a solenoid can be used to magnetise a piece of magnetic material, like soft iron, when placed inside the coil (Fig. 13.11). The magnet so formed is called an electromagnet.

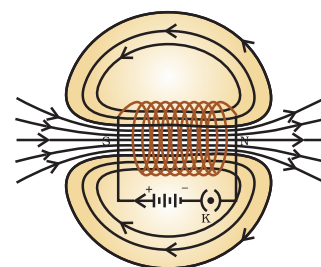

Figure 13.10
Field lines of the magnetic field through and around a current carrying solenoid.

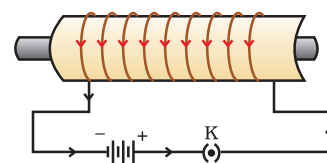

Figure 13.11
A current-carrying solenoid coil is used to magnetise steel rod inside it – an electromagnet.

Q U E S T I O N S

1. Consider a circular loop of wire lying in the plane of the table. Let the current pass through the loop clockwise. Apply the right-hand rule to find out the direction of the magnetic field inside and outside the loop.
2. The magnetic field in a given region is uniform. Draw a diagram to represent it.



3. Choose the correct option.

The magnetic field inside a long straight solenoid-carrying current

- (a) is zero.
- (b) decreases as we move towards its end.
- (c) increases as we move towards its end.
- (d) is the same at all points.

13.3 FORCE ON A CURRENT-CARRYING CONDUCTOR IN A MAGNETIC FIELD

We have learnt that an electric current flowing through a conductor produces a magnetic field. The field so produced exerts a force on a magnet placed in the vicinity of the conductor. French scientist Andre Marie Ampere (1775–1836) suggested that the magnet must also exert an equal and opposite force on the current-carrying conductor. The force due to a magnetic field acting on a current-carrying conductor can be demonstrated through the following activity.

Activity 13.7

- Take a small aluminium rod AB (of about 5 cm). Using two connecting wires suspend it horizontally from a stand, as shown in Fig. 13.12.
- Place a strong horse-shoe magnet in such a way that the rod lies between the two poles with the magnetic field directed upwards. For this put the north pole of the magnet vertically below and south pole vertically above the aluminium rod (Fig. 13.12).
- Connect the aluminium rod in series with a battery, a key and a rheostat.
- Now pass a current through the aluminium rod from end B to end A.
- What do you observe? It is observed that the rod is displaced towards the left. You will notice that the rod gets displaced.
- Reverse the direction of current flowing through the rod and observe the direction of its displacement. It is now towards the right. Why does the rod get displaced?

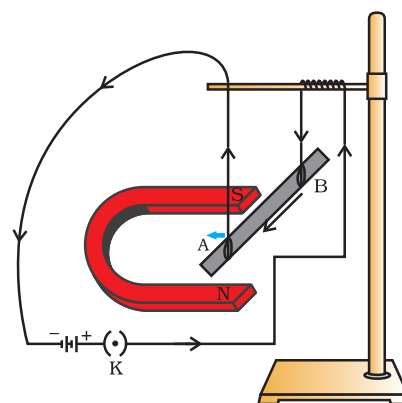

Figure 13.12

A current-carrying rod, AB, experiences a force perpendicular to its length and the magnetic field. Support for the magnet is not shown here, for simplicity.

The displacement of the rod in the above activity suggests that a force is exerted on the current-carrying aluminium rod when it is placed in a magnetic field. It also suggests that the direction of force is also reversed when the direction of current through the conductor is reversed. Now change the direction of field to vertically downwards by interchanging the two poles of the magnet. It is once again observed that

the direction of force acting on the current-carrying rod gets reversed. It shows that the direction of the force on the conductor depends upon the direction of current and the direction of the magnetic field. Experiments have shown that the displacement of the rod is largest (or the magnitude of the force is the highest) when the direction of current is at right angles to the direction of the magnetic field. In such a condition we can use a simple rule to find the direction of the force on the conductor.

In Activity 13.7, we considered the direction of the current and that of the magnetic field perpendicular to each other and found that the force is perpendicular to both of them. The three directions can be illustrated through a simple rule, called Fleming's left-hand rule. According to this rule, stretch the thumb, forefinger and middle finger of your left hand such that they are mutually perpendicular (Fig. 13.13). If the first finger points in the direction of magnetic field and the second finger in the direction of current, then the thumb will point in the direction of motion or the force acting on the conductor.

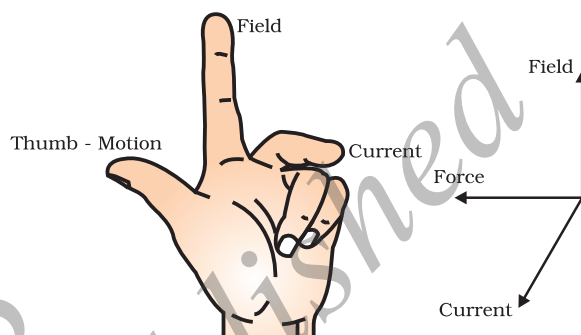

Figure 13.13
Fleming's left-hand rule

Devices that use current-carrying conductors and magnetic fields include electric motor, electric generator, loudspeakers, microphones and measuring instruments. In the next few sections we shall study about electric motors and generators.

Example 13.2

An electron enters a magnetic field at right angles to it, as shown in Fig. 13.14. The direction of force acting on the electron will be

- to the right.
- to the left.
- out of the page.
- into the page.

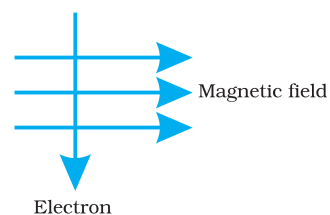

Figure 13.14

Solution

Answer is option (d). The direction of force is perpendicular to the direction of magnetic field and current as given by Fleming's left hand rule. Recall that the direction of current is taken opposite to the direction of motion of electrons. The force is therefore directed into the page.

Q U E S T I O N S

- Which of the following property of a proton can change while it moves freely in a magnetic field? (There may be more than one correct answer.)
 - mass
 - speed
 - velocity
 - momentum



2. In Activity 13.7, how do we think the displacement of rod AB will be affected if (i) current in rod AB is increased; (ii) a stronger horse-shoe magnet is used; and (iii) length of the rod AB is increased?
3. A positively-charged particle (alpha-particle) projected towards west is deflected towards north by a magnetic field. The direction of magnetic field is
 - (a) towards south
 - (b) towards east
 - (c) downward
 - (d) upward

More to Know!

Magnetism in medicine

An electric current always produces a magnetic field. Even weak ion currents that travel along the nerve cells in our body produce magnetic fields. When we touch something, our nerves carry an electric impulse to the muscles we need to use. This impulse produces a temporary magnetic field. These fields are very weak and are about one-billionth of the earth's magnetic field. Two main organs in the human body where the magnetic field produced is significant, are the heart and the brain. The magnetic field inside the body forms the basis of obtaining the images of different body parts. This is done using a technique called Magnetic Resonance Imaging (MRI). Analysis of these images helps in medical diagnosis. Magnetism has, thus, got important uses in medicine.

13.4 ELECTRIC MOTOR

An electric motor is a rotating device that converts electrical energy to mechanical energy. Electric motor is used as an important component in electric fans, refrigerators, mixers, washing machines, computers, MP3 players etc. Do you know how an electric motor works?

An electric motor, as shown in Fig. 13.15, consists of a rectangular coil ABCD of insulated copper wire. The coil is placed between the two poles of a magnetic field such that the arm AB and CD are perpendicular to the direction of the magnetic field. The ends of the coil are connected to the two halves P and Q of a split ring. The inner sides of these halves are insulated and attached to an axle. The external conducting edges of P and Q touch two conducting stationary brushes X and Y, respectively, as shown in the Fig. 13.15.

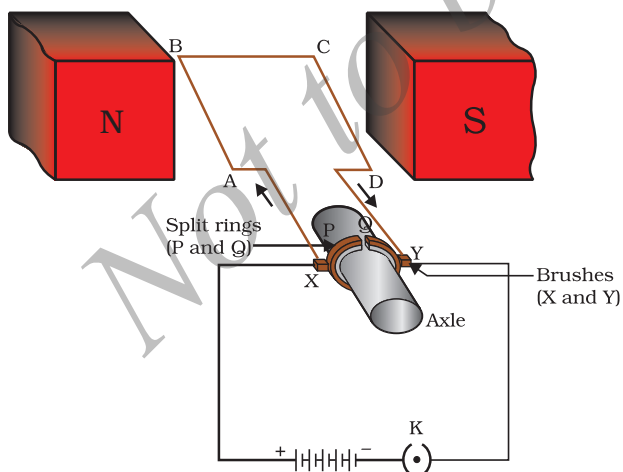

Figure 13.15
A simple electric motor

Current in the coil ABCD enters from the source battery through conducting brush X and flows back to the battery through brush Y. Notice that the current in arm AB of the coil flows from A to B. In arm CD it flows from C to D, that is, opposite to the direction of current through arm AB. On applying Fleming's left hand rule for the direction of force on a current-carrying

Current in the coil ABCD enters from the source battery through conducting brush X and flows back to the battery through brush Y. Notice that the current in arm AB of the coil flows from A to B. In arm CD it flows from C to D, that is, opposite to the direction of current through arm AB. On applying Fleming's left hand rule for the direction of force on a current-carrying

conductor in a magnetic field (see Fig. 13.13). We find that the force acting on arm AB pushes it downwards while the force acting on arm CD pushes it upwards. Thus the coil and the axle O, mounted free to turn about an axis, rotate anti-clockwise. At half rotation, Q makes contact with the brush X and P with brush Y. Therefore the current in the coil gets reversed and flows along the path DCBA. A device that reverses the direction of flow of current through a circuit is called a commutator. In electric motors, the split ring acts as a commutator. The reversal of current also reverses the direction of force acting on the two arms AB and CD. Thus the arm AB of the coil that was earlier pushed down is now pushed up and the arm CD previously pushed up is now pushed down. Therefore the coil and the axle rotate half a turn more in the same direction. The reversing of the current is repeated at each half rotation, giving rise to a continuous rotation of the coil and to the axle.

The commercial motors use (i) an electromagnet in place of permanent magnet; (ii) large number of turns of the conducting wire in the current-carrying coil; and (iii) a soft iron core on which the coil is wound. The soft iron core, on which the coil is wound, plus the coils, is called an armature. This enhances the power of the motor.

Q U E S T I O N S

1. State Fleming's left-hand rule.
2. What is the principle of an electric motor?
3. What is the role of the split ring in an electric motor?



13.5 ELECTROMAGNETIC INDUCTION

We have studied that when a current-carrying conductor is placed in a magnetic field such that the direction of current is perpendicular to the magnetic field, it experiences a force. This force causes the conductor to move. Now let us imagine a situation in which a conductor is moving inside a magnetic field or a magnetic field is changing around a fixed conductor. What will happen? This was first studied by English physicist Michael Faraday. In 1831, Faraday made an important breakthrough by discovering how a moving magnet can be used to generate electric currents. To observe this effect, let us perform the following activity.

Activity 13.8

- Take a coil of wire AB having a large number of turns.
- Connect the ends of the coil to a galvanometer as shown in Fig. 13.16.
- Take a strong bar magnet and move its north pole towards the end B of the coil. Do you find any change in the galvanometer needle?

- There is a momentary deflection in the needle of the galvanometer, say to the right. This indicates the presence of a current in the coil AB. The deflection becomes zero the moment the motion of the magnet stops.
- Now withdraw the north pole of the magnet away from the coil. Now the galvanometer is deflected toward the left, showing that the current is now set up in the direction opposite to the first.
- Place the magnet stationary at a point near to the coil, keeping its north pole towards the end B of the coil. We see that the galvanometer needle deflects toward the right when the coil is moved towards the north pole of the magnet. Similarly the needle moves toward left when the coil is moved away.
- When the coil is kept stationary with respect to the magnet, the deflection of the galvanometer drops to zero. What do you conclude from this activity?

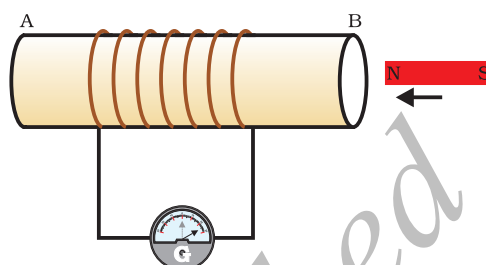
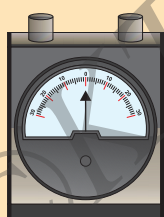

Figure 13.16
Moving a magnet towards a coil sets up a current in the coil circuit, as indicated by deflection in the galvanometer needle.



A galvanometer is an instrument that can detect the presence of a current in a circuit. The pointer remains at zero (the centre of the scale) for zero current flowing through it. It can deflect either to the left or to the right of the zero mark depending on the direction of current.

You can also check that if you had moved south pole of the magnet towards the end B of the coil, the deflections in the galvanometer would just be opposite to the previous case. When the coil and the magnet are both stationary, there is no deflection in the galvanometer. It is, thus, clear from this activity that motion of a magnet with respect to the coil produces an induced potential difference, which sets up an induced electric current in the circuit.

Michael Faraday (1791–1867)



Michael Faraday was an experimental physicist. He had no formal education. He worked in a book-binding shop during his early years. He used to read books that came for binding. This way Faraday developed his interest in science. He got an opportunity to listen to some public lectures by Humphrey Davy of Royal Institute. He made careful notes of Davy's lectures and sent them to Davy. Soon he was made an assistant in Davy's laboratory at the Royal Institute. Faraday made several path-breaking discoveries that include electromagnetic induction and the laws of electrolysis. Several universities conferred

on him the honorary degrees but he turned down such honours. Faraday loved his science work more than any honour.

Let us now perform a variation of Activity 13.8 in which the moving magnet is replaced by a current-carrying coil and the current in the coil can be varied.

Activity 13.9

- Take two different coils of copper wire having large number of turns (say 50 and 100 turns respectively). Insert them over a non-conducting cylindrical roll, as shown in Fig. 13.17. (You may use a thick paper roll for this purpose.)
- Connect the coil-1, having larger number of turns, in series with a battery and a plug key. Also connect the other coil-2 with a galvanometer as shown.
- Plug in the key. Observe the galvanometer. Is there a deflection in its needle? You will observe that the needle of the galvanometer instantly jumps to one side and just as quickly returns to zero, indicating a momentary current in coil-2.
- Disconnect coil-1 from the battery. You will observe that the needle momentarily moves, but to the opposite side. It means that now the current flows in the opposite direction in coil-2.

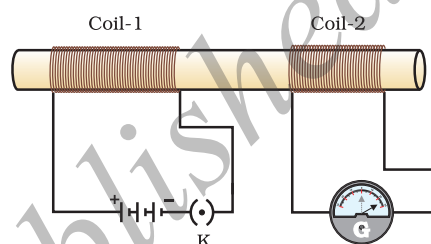

Figure 13.17
Current is induced in coil-2 when current in coil-1 is changed

In this activity we observe that as soon as the current in coil-1 reaches either a steady value or zero, the galvanometer in coil-2 shows no deflection.

From these observations, we conclude that a potential difference is induced in the coil-2 whenever the electric current through the coil-1 is changing (starting or stopping). Coil-1 is called the primary coil and coil-2 is called the secondary coil. As the current in the first coil changes, the magnetic field associated with it also changes. Thus the magnetic field lines around the secondary coil also change. Hence the change in magnetic field lines associated with the secondary coil is the cause of induced electric current in it. This process, by which a changing magnetic field in a conductor induces a current in another conductor, is called electromagnetic induction. In practice we can induce current in a coil either by moving it in a magnetic field or by changing the magnetic field around it. It is convenient in most situations to move the coil in a magnetic field.

The induced current is found to be the highest when the direction of motion of the coil is at right angles to the magnetic field. In this situation, we can use a simple rule to know the direction of the induced current. Stretch the thumb, forefinger and middle finger of right hand so that they are perpendicular to each other, as shown in Fig. 13.18. If the forefinger indicates the direction of the magnetic field and the thumb shows the direction of motion of conductor, then the middle finger will show the direction of induced current. This simple rule is called Fleming's right-hand rule.

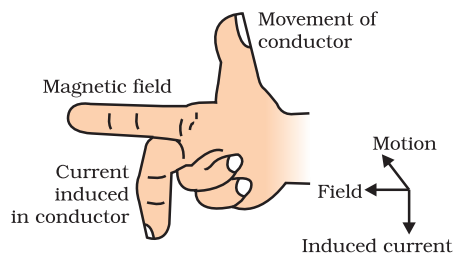

Figure 13.18
Fleming's right-hand rule

Q U E S T I O N

1. Explain different ways to induce current in a coil.



13.6 ELECTRIC GENERATOR

Based on the phenomenon of electromagnetic induction, the experiments studied above generate induced current, which is usually very small. This principle is also employed to produce large currents for use in homes and industry. In an electric generator, mechanical energy is used to rotate a conductor in a magnetic field to produce electricity.

An electric generator, as shown in Fig. 13.19, consists of a rotating rectangular coil ABCD placed between the two poles of a permanent magnet. The two ends of this coil are connected to the two rings R_1 and R_2 . The inner side of these rings are made insulated. The two conducting stationary brushes B_1 and B_2 are kept pressed separately on the rings R_1 and R_2 , respectively. The two rings R_1 and R_2 are internally attached to an axle. The axle may be mechanically rotated from outside to rotate the coil inside the magnetic field. Outer ends of the two brushes are connected to the galvanometer to show the flow of current in the given external circuit.

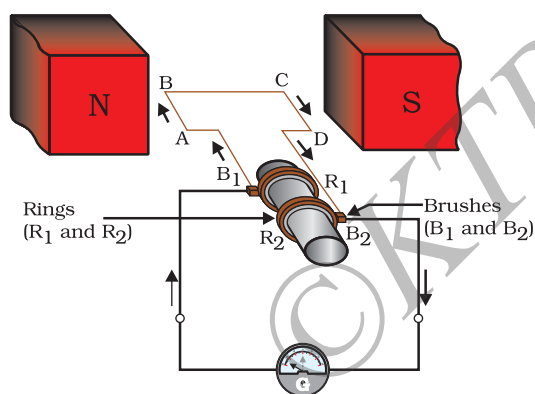

Figure 13.19
Illustration of the principle of electric generator

When the axle attached to the two rings is rotated such that the arm AB moves up (and the arm CD moves down) in the magnetic field produced by the permanent magnet. Let us say the coil ABCD is rotated clockwise in the arrangement shown in Fig. 13.19. By applying Fleming's right-hand rule, the induced currents are set up in these arms along the directions AB and CD. Thus an induced current flows in the direction ABCD. If there are larger numbers of turns in the coil, the current generated in each turn adds up to give a large current through the coil. This means that the current in the external circuit flows from B_2 to B_1 .

After half a rotation, arm CD starts moving up and AB moving down. As a result, the directions of the induced currents in both the arms change, giving rise to the net induced current in the direction DCBA. The current in the external circuit now flows from B_1 to B_2 . Thus after every half rotation the polarity of the current in the respective arms changes. Such a current, which changes direction after equal intervals of time, is called an alternating current (abbreviated as AC). This device is called an AC generator.

To get a direct current (DC, which does not change its direction with time), a split-ring type commutator must be used. With this arrangement, one brush is at all times in contact with the arm moving up in the field, while the other is in contact with the arm moving down. We have seen the working of a split ring commutator in the case of an electric motor

(see Fig. 13.15). Thus a unidirectional current is produced. The generator is thus called a DC generator.

The difference between the direct and alternating currents is that the direct current always flows in one direction, whereas the alternating current reverses its direction periodically. Most power stations constructed these days produce AC. In India, the AC changes direction after every $1/100$ second, that is, the frequency of AC is 50 Hz. An important advantage of AC over DC is that electric power can be transmitted over long distances without much loss of energy.

Q U E S T I O N S

1. State the principle of an electric generator.
2. Name some sources of direct current.
3. Which sources produce alternating current?
4. Choose the correct option.

A rectangular coil of copper wires is rotated in a magnetic field. The direction of the induced current changes once in each

- | | |
|---------------------|---------------------------|
| (a) two revolutions | (b) one revolution |
| (c) half revolution | (d) one-fourth revolution |

13.7 DOMESTIC ELECTRIC CIRCUITS

In our homes, we receive supply of electric power through a main supply (also called mains), either supported through overhead electric poles or by underground cables. One of the wires in this supply, usually with red insulation cover, is called live wire (or positive). Another wire, with black insulation, is called neutral wire (or negative). In our country, the potential difference between the two is 220 V.

At the meter-board in the house, these wires pass into an electricity meter through a main fuse. Through the main switch they are connected to the line wires in the house. These wires supply electricity to separate circuits within the house. Often, two separate circuits are used, one of 15 A current rating for appliances with higher power ratings such as geysers, air coolers, etc. The other circuit is of 5 A current rating for bulbs, fans, etc. The earth wire, which has insulation of green colour, is usually connected to a metal plate deep in the earth near the house. This is used as a safety measure, especially for those appliances that have a metallic body, for example, electric press, toaster, table fan, refrigerator, etc. The metallic body is connected to the earth wire, which provides a low-resistance conducting path for the current. Thus, it ensures that any leakage of current to the metallic body of the appliance keeps its potential to that of the earth, and the user may not get a severe electric shock.

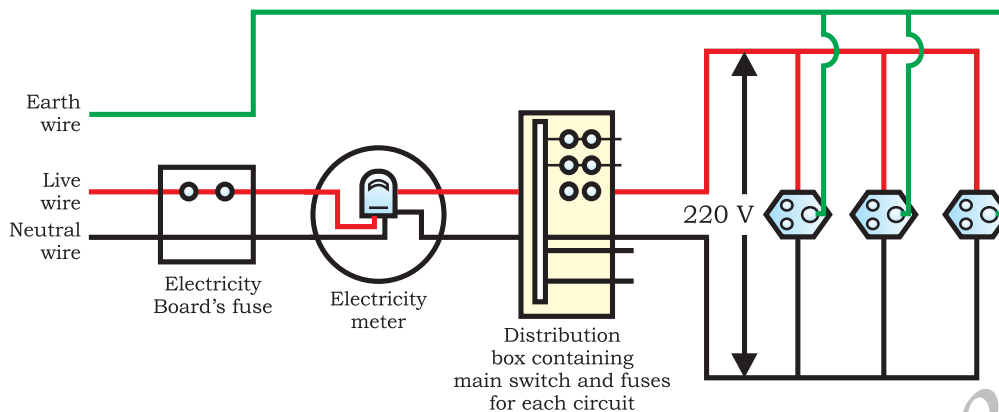

Figure 13.20 A schematic diagram of one of the common domestic circuits

Figure 13.20 gives a schematic diagram of one of the common domestic circuits. In each separate circuit, different appliances can be connected across the live and neutral wires. Each appliance has a separate switch to 'ON'/'OFF' the flow of current through it. In order that each appliance has equal potential difference, they are connected parallel to each other.

Electric fuse is an important component of all domestic circuits. We have already studied the principle and working of a fuse in the previous chapter (see Section 12.7). A fuse in a circuit prevents damage to the appliances and the circuit due to overloading. Overloading can occur when the live wire and the neutral wire come into direct contact. (This occurs when the insulation of wires is damaged or there is a fault in the appliance.) In such a situation, the current in the circuit abruptly increases. This is called short-circuiting. The use of an electric fuse prevents the electric circuit and the appliance from a possible damage by stopping the flow of unduly high electric current. The Joule heating that takes place in the fuse melts it to break the electric circuit. Overloading can also occur due to an accidental hike in the supply voltage. Sometimes overloading is caused by connecting too many appliances to a single socket.

Q U E S T I O N S

1. Name two safety measures commonly used in electric circuits and appliances.
2. An electric oven of 2 kW power rating is operated in a domestic electric circuit (220 V) that has a current rating of 5 A. What result do you expect? Explain.
3. What precaution should be taken to avoid the overloading of domestic electric circuits?



What you have learnt

- A compass needle is a small magnet. Its one end, which points towards north, is called a north pole, and the other end, which points towards south, is called a south pole.
- A magnetic field exists in the region surrounding a magnet, in which the force of the magnet can be detected.
- Field lines are used to represent a magnetic field. A field line is the path along which a hypothetical free north pole would tend to move. The direction of the magnetic field at a point is given by the direction that a north pole placed at that point would take. Field lines are shown closer together where the magnetic field is greater.
- A metallic wire carrying an electric current has associated with it a magnetic field. The field lines about the wire consist of a series of concentric circles whose direction is given by the right-hand rule.
- The pattern of the magnetic field around a conductor due to an electric current flowing through it depends on the shape of the conductor. The magnetic field of a solenoid carrying a current is similar to that of a bar magnet.
- An electromagnet consists of a core of soft iron wrapped around with a coil of insulated copper wire.
- A current-carrying conductor when placed in a magnetic field experiences a force. If the direction of the field and that of the current are mutually perpendicular to each other, then the force acting on the conductor will be perpendicular to both and will be given by Fleming's left-hand rule. This is the basis of an electric motor. An electric motor is a device that converts electric energy into mechanical energy.
- The phenomenon of electromagnetic induction is the production of induced current in a coil placed in a region where the magnetic field changes with time. The magnetic field may change due to a relative motion between the coil and a magnet placed near to the coil. If the coil is placed near to a current-carrying conductor, the magnetic field may change either due to a change in the current through the conductor or due to the relative motion between the coil and conductor. The direction of the induced current is given by the Fleming's right-hand rule.
- A generator converts mechanical energy into electrical energy. It works on the basis of electromagnetic induction.
- In our houses we receive AC electric power of 220 V with a frequency of 50 Hz. One of the wires in this supply is with red insulation, called live wire. The other one is of black insulation, which is a neutral wire. The potential difference between the two is 220 V. The third is the earth wire that has green insulation and this is connected to a metallic body deep inside earth. It is used as a safety measure to ensure that any leakage of current to a metallic body does not give any severe shock to a user.
- Fuse is the most important safety device, used for protecting the circuits due to short-circuiting or overloading of the circuits.

EXERCISES

- Which of the following correctly describes the magnetic field near a long straight wire?
 - The field consists of straight lines perpendicular to the wire.
 - The field consists of straight lines parallel to the wire.
 - The field consists of radial lines originating from the wire.
 - The field consists of concentric circles centred on the wire.
- The phenomenon of electromagnetic induction is
 - the process of charging a body.
 - the process of generating magnetic field due to a current passing through a coil.
 - producing induced current in a coil due to relative motion between a magnet and the coil.
 - the process of rotating a coil of an electric motor.
- The device used for producing electric current is called a
 - generator.
 - galvanometer.
 - ammeter.
 - motor.
- The essential difference between an AC generator and a DC generator is that
 - AC generator has an electromagnet while a DC generator has permanent magnet.
 - DC generator will generate a higher voltage.
 - AC generator will generate a higher voltage.
 - AC generator has slip rings while the DC generator has a commutator.
- At the time of short circuit, the current in the circuit
 - reduces substantially.
 - does not change.
 - increases heavily.
 - vary continuously.
- State whether the following statements are true or false.
 - An electric motor converts mechanical energy into electrical energy.
 - An electric generator works on the principle of electromagnetic induction.
 - The field at the centre of a long circular coil carrying current will be parallel straight lines.
 - A wire with a green insulation is usually the live wire of an electric supply.
- List two methods of producing magnetic fields.

8. How does a solenoid behave like a magnet? Can you determine the north and south poles of a current-carrying solenoid with the help of a bar magnet? Explain.
9. When is the force experienced by a current-carrying conductor placed in a magnetic field largest?
10. Imagine that you are sitting in a chamber with your back to one wall. An electron beam, moving horizontally from back wall towards the front wall, is deflected by a strong magnetic field to your right side. What is the direction of magnetic field?
11. Draw a labelled diagram of an electric motor. Explain its principle and working. What is the function of a split ring in an electric motor?
12. Name some devices in which electric motors are used.
13. A coil of insulated copper wire is connected to a galvanometer. What will happen if a bar magnet is (i) pushed into the coil, (ii) withdrawn from inside the coil, (iii) held stationary inside the coil?
14. Two circular coils A and B are placed closed to each other. If the current in the coil A is changed, will some current be induced in the coil B? Give reason.
15. State the rule to determine the direction of a (i) magnetic field produced around a straight conductor-carrying current, (ii) force experienced by a current-carrying straight conductor placed in a magnetic field which is perpendicular to it, and (iii) current induced in a coil due to its rotation in a magnetic field.
16. Explain the underlying principle and working of an electric generator by drawing a labelled diagram. What is the function of brushes?
17. When does an electric short circuit occur?
18. What is the function of an earth wire? Why is it necessary to earth metallic appliances?



CHAPTER 15



Our Environment

We have heard the word 'environment' often being used on the television, in newspapers and by people around us. Our elders tell us that the 'environment' is not what it used to be earlier; others say that we should work in a healthy 'environment'; and global summits involving the developed and developing countries are regularly held to discuss 'environmental' issues. In this chapter, we shall be studying how various components in the environment interact with each other and how we impact the environment.

15.1 ECO-SYSTEM — WHAT ARE ITS COMPONENTS?

All organisms such as plants, animals, microorganisms and human beings as well as the physical surroundings interact with each other and maintain a balance in nature. All the interacting organisms in an area together with the non-living constituents of the environment form an ecosystem. Thus, an ecosystem consists of biotic components comprising living organisms and abiotic components comprising physical factors like temperature, rainfall, wind, soil and minerals.

For example, if you visit a garden you will find different plants, such as grasses, trees; flower bearing plants like rose, jasmine, sunflower; and animals like frogs, insects and birds. All these living organisms interact with each other and their growth, reproduction and other activities are affected by the abiotic components of ecosystem. So a garden is an ecosystem. Other types of ecosystems are forests, ponds and lakes. These are natural ecosystems while gardens and crop-fields are human-made (artificial) ecosystems.

Activity 15.1

- You might have seen an aquarium. Let us try to design one.
- What are the things that we need to keep in mind when we create an aquarium? The fish would need a free space for swimming (it could be a large jar), water, oxygen and food.
- We can provide oxygen through an oxygen pump (aerator) and fish food which is available in the market.

- If we add a few aquatic plants and animals it can become a self-sustaining system. Can you think how this happens? An aquarium is an example of a human-made ecosystem.
- Can we leave the aquarium as such after we set it up? Why does it have to be cleaned once in a while? Do we have to clean ponds or lakes in the same manner? Why or why not?

We have seen in earlier classes that organisms can be grouped as producers, consumers and decomposers according to the manner in which they obtain their sustenance from the environment. Let us recall what we have learnt through the self-sustaining ecosystem created by us above. Which organisms can make organic compounds like sugar and starch from inorganic substances using the radiant energy of the Sun in the presence of chlorophyll? All green plants and certain bacteria which can produce food by photosynthesis come under this category and are called the producers.

Organisms depend on the producers either directly or indirectly for their sustenance? These organisms which consume the food produced, either directly from producers or indirectly by feeding on other consumers are the consumers. Consumers can be classed variously as herbivores, carnivores, omnivores and parasites. Can you give examples for each of these categories of consumers?

- Imagine the situation where you do not clean the aquarium and some fish and plants have died. Have you ever thought what happens when an organism dies? The microorganisms, comprising bacteria and fungi, break-down the dead remains and waste products of organisms. These microorganisms are the decomposers as they break-down the complex organic substances into simple inorganic substances that go into the soil and are used up once more by the plants. What will happen to the garbage, and dead animals and plants in their absence? Will the natural replenishment of the soil take place, even if decomposers are not there?

Activity 15.2

- While creating an aquarium did you take care not to put an aquatic animal which would eat others? What would have happened otherwise?
- Make groups and discuss how each of the above groups of organisms are dependent on each other.
- Write the aquatic organisms in order of who eats whom and form a chain of at least three steps. → →
- Would you consider any one group of organisms to be of primary importance? Why or why not?

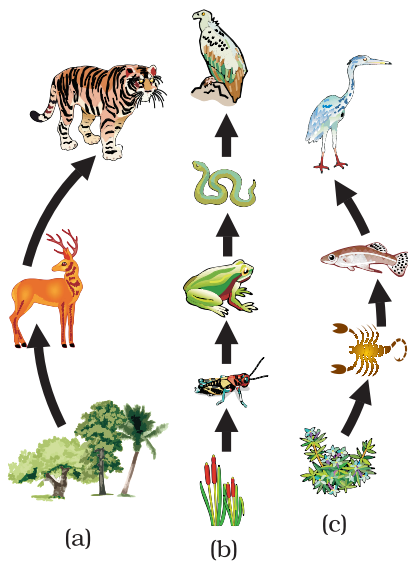

Figure 15.1
Food chain in nature
(a) in forest, (b) in
grassland and (c) in a
pond

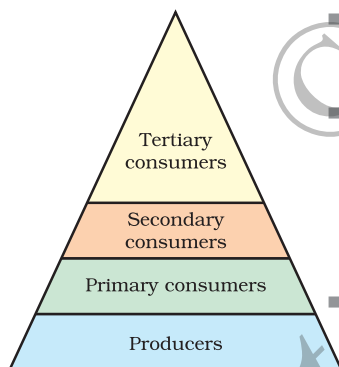

Figure 15.2
Trophic levels

15.1.1 Food Chains and Webs

In Activity 15.4 we have formed a series of organisms feeding on one another. This series of organisms taking part at various biotic levels form a food chain (Fig. 15.1).

Each step or level of the food chain forms a trophic level. The autotrophs or the producers are at the first trophic level. They fix up the solar energy and make it available for heterotrophs or the consumers. The herbivores or the primary consumers come at the second, small carnivores or the secondary consumers at the third and larger carnivores or the tertiary consumers form the fourth trophic level (Fig. 15.2).

We know that the food we eat acts as a fuel to provide us energy to do work. Thus the interactions among various components of the environment involves flow of energy from one component of the system to another. As we have studied, the autotrophs capture the energy present in sunlight and convert it into chemical energy. This energy supports all the activities of the living world. From autotrophs, the energy goes to the heterotrophs and decomposers. However, as we saw in the previous Chapter on 'Sources of Energy', when one form of energy is changed to another, some energy is lost to the environment in forms which cannot be used again. The flow of energy between various components of the environment has been extensively studied and it has been found that –

The green plants in a terrestrial ecosystem capture about 1% of the energy of sunlight that falls on their leaves and convert it into food energy.

When green plants are eaten by primary consumers, a great deal of energy is lost as heat to the environment, some amount goes into digestion and in doing work and the rest goes towards growth and reproduction. An average of 10% of the food eaten is turned into its own body and made available for the next level of consumers.

- Therefore, 10% can be taken as the average value for the amount of organic matter that is present at each step and reaches the next level of consumers.
- Since so little energy is available for the next level of consumers, food chains generally consist of only three or four steps. The loss of energy at each step is so great that very little usable energy remains after four trophic levels.
- There are generally a greater number of individuals at the lower trophic levels of an ecosystem, the greatest number is of the producers.
- The length and complexity of food chains vary greatly. Each organism is generally eaten by two or more other kinds of organisms which in turn are eaten by several other organisms. So instead of a straight line food chain, the relationship can be shown as a series of branching lines called a food web (Fig. 15.3).

From the energy flow diagram (Fig. 15.4), two things become clear. Firstly, the flow of energy is unidirectional. The energy that is captured by the autotrophs does not revert back to the solar input and the energy which passes to the herbivores does not come back to autotrophs. As it moves progressively through the various trophic levels it is no longer available to the previous level. Secondly, the energy available at each trophic level gets diminished progressively due to loss of energy at each level.

Another interesting aspect of food chain is how unknowingly some harmful chemicals enter our bodies through the food chain. You have read in Class IX how water gets polluted. One of the reasons is the use of several pesticides and other chemicals to protect our crops from diseases and pests. These chemicals are either washed down into the soil or into the water bodies. From the soil, these are absorbed by the plants along with water and minerals, and from the water bodies these are taken up by aquatic plants

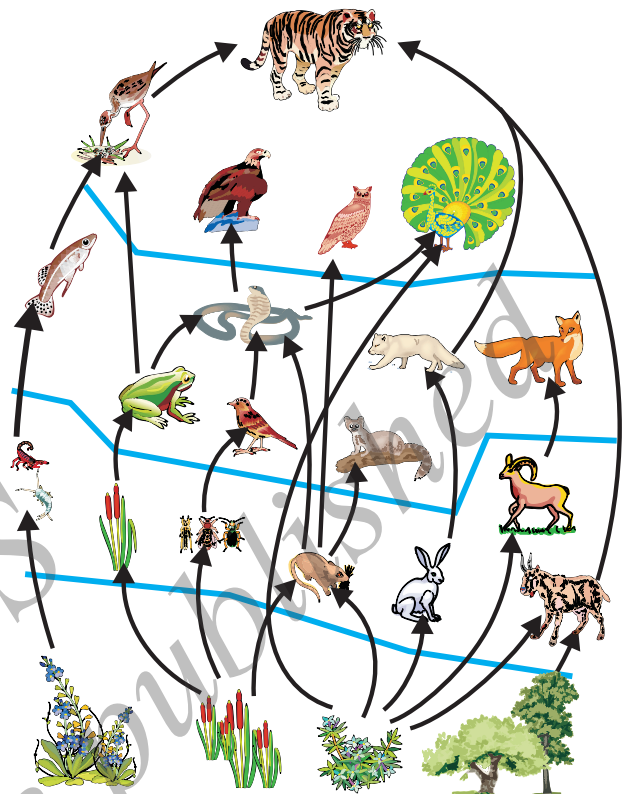

Figure 15.3
Food web, consisting of many food chains

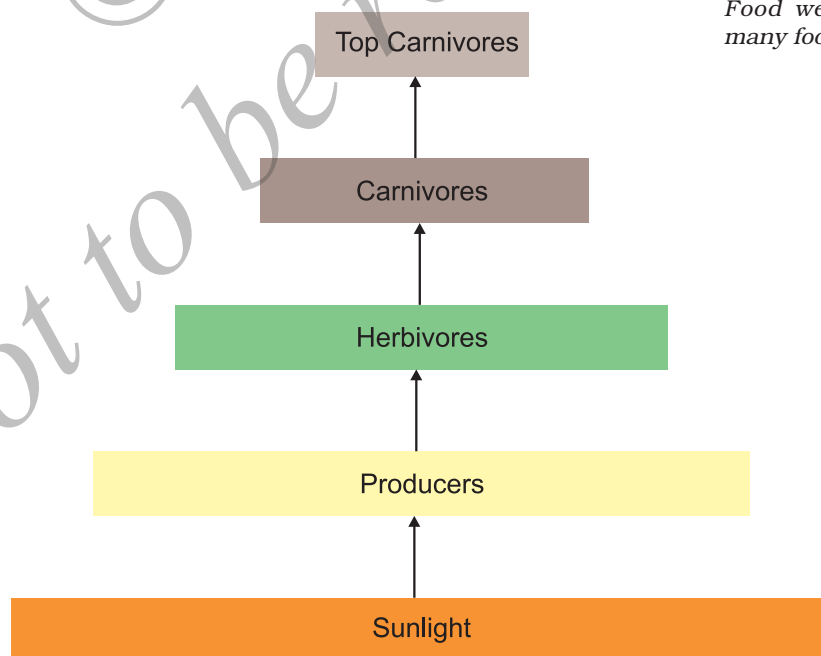

Figure 15.4 Diagram showing flow of energy in an ecosystem

and animals. This is one of the ways in which they enter the food chain. As these chemicals are not degradable, these get accumulated progressively at each trophic level. As human beings occupy the top level in any food chain, the maximum concentration of these chemicals get accumulated in our bodies. This phenomenon is known as biological magnification. This is the reason why our food grains such as wheat and rice, vegetables and fruits, and even meat, contain varying amounts of pesticide residues. They cannot always be removed by washing or other means.

Activity 15.3

- Newspaper reports about pesticide levels in ready-made food items are often seen these days and some states have banned these products. Debate in groups the need for such bans.
- What do you think would be the source of pesticides in these food items? Could pesticides get into our bodies from this source through other food products too?
- Discuss what methods could be applied to reduce our intake of pesticides.

Q U E S T I O N S

1. What are trophic levels? Give an example of a food chain and state the different trophic levels in it.
2. What is the role of decomposers in the ecosystem?



15.2 HOW DO OUR ACTIVITIES AFFECT THE ENVIRONMENT?

We are an integral part of the environment. Changes in the environment affect us and our activities change the environment around us. We have already seen in Class IX how our activities pollute the environment. In this chapter, we shall be looking at two of the environmental problems in detail, that is, depletion of the ozone layer and waste disposal.

15.2.1 Ozone Layer and How it is Getting Depleted

Ozone (O_3) is a molecule formed by three atoms of oxygen. While O_2 , which we normally refer to as oxygen, is essential for all aerobic forms of life. Ozone, is a deadly poison. However, at the higher levels of the atmosphere, ozone performs an essential function. It shields the surface of the earth from ultraviolet (UV) radiation from the Sun. This radiation

is highly damaging to organisms, for example, it is known to cause skin cancer in human beings.

Ozone at the higher levels of the atmosphere is a product of UV radiation acting on oxygen (O_2) molecule. The higher energy UV radiations split apart some molecular oxygen (O_2) into free oxygen (O) atoms. These atoms then combine with the molecular oxygen to form ozone as shown—

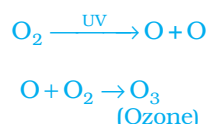

The amount of ozone in the atmosphere began to drop sharply in the 1980s. This decrease has been linked to synthetic chemicals like chlorofluorocarbons (CFCs) which are used as refrigerants and in fire extinguishers. In 1987, the United Nations Environment Programme (UNEP) succeeded in forging an agreement to freeze CFC production at 1986 levels. It is now mandatory for all the manufacturing companies to make CFC-free refrigerators throughout the world.

Activity 15.4

- Find out from the library, internet or newspaper reports, which chemicals are responsible for the depletion of the ozone layer.
- Find out if the regulations put in place to control the emission of these chemicals have succeeded in reducing the damage to the ozone layer. Has the size of the hole in the ozone layer changed in recent years?

15.2.2 Managing the Garbage we Produce

In our daily activities, we generate a lot of material that are thrown away. What are some of these waste materials? What happens after we throw them away? Let us perform an activity to find answers to these questions.

Activity 15.5

- Collect waste material from your homes. This could include all the waste generated during a day, like kitchen waste (spoilt food, vegetable peels, used tea leaves, milk packets and empty cartons), waste paper, empty medicine bottles/strips/bubble packs, old and torn clothes and broken footwear.
- Bury this material in a pit in the school garden or if there is no space available, you can collect the material in an old bucket/flower pot and cover with at least 15 cm of soil.
- Keep this material moist and observe at 15-day intervals.
- What are the materials that remain unchanged over long periods of time?
- What are the materials which change their form and structure over time?
- Of these materials that are changed, which ones change the fastest?

We have seen in the chapter on 'Life Processes' that the food we eat is digested by various enzymes in our body. Have you ever wondered why the same enzyme does not break-down everything we eat? Enzymes are specific in their action, specific enzymes are needed for the break-down of a particular substance. That is why we will not get any energy if we try to eat coal! Because of this, many human-made materials like plastics will not be broken down by the action of bacteria or other saprophytes. These materials will be acted upon by physical processes like heat and pressure, but under the ambient conditions found in our environment, these persist for a long time.

Substances that are broken down by biological processes are said to be biodegradable. How many of the substances you buried were biodegradable? Substances that are not broken down in this manner are said to be non-biodegradable. These substances may be inert and simply persist in the environment for a long time or may harm the various members of the eco-system.

Activity 15.6

- Use the library or internet to find out more about biodegradable and non-biodegradable substances.
- How long are various non-biodegradable substances expected to last in our environment?
- These days, new types of plastics which are said to be biodegradable are available. Find out more about such materials and whether they do or do not harm the environment.

Q U E S T I O N S

1. Why are some substances biodegradable and some non-biodegradable?
2. Give any two ways in which biodegradable substances would affect the environment.
3. Give any two ways in which non-biodegradable substances would affect the environment.



Visit any town or city, and we are sure to find heaps of garbage all over the place. Visit any place of tourist interest and we are sure to find the place littered with empty food wrappers. In the earlier classes we have talked about this problem of dealing with the garbage that we generate. Let us now look at the problem a bit more deeply.

Activity 15.7

- Find out what happens to the waste generated at home. Is there a system in place to collect this waste?
- Find out how the local body (*panchayat*, municipal corporation, resident welfare association) deals with the waste. Are there mechanisms in place to treat the biodegradable and non-biodegradable wastes separately?
- Calculate how much waste is generated at home in a day.
- How much of this waste is biodegradable?
- Calculate how much waste is generated in the classroom in a day.
- How much of this waste is biodegradable?
- Suggest ways of dealing with this waste.

Activity 15.8

- Find out how the sewage in your locality is treated. Are there mechanisms in place to ensure that local water bodies are not polluted by untreated sewage.
- Find out how the local industries in your locality treat their wastes. Are there mechanisms in place to ensure that the soil and water are not polluted by this waste?

Improvements in our life-style have resulted in greater amounts of waste material generation. Changes in attitude also have a role to play, with more and more things we use becoming disposable. Changes in packaging have resulted in much of our waste becoming non-biodegradable. What do you think will be the impact of these on our environment?

Think it over

Disposable cups in trains

If you ask your parents, they will probably remember a time when tea in trains was served in plastic glasses which had to be returned to the vendor. The introduction of disposable cups was hailed as a step forward for reasons of hygiene. No one at that time perhaps thought about the impact caused by the disposal of millions of these cups on a daily basis. Some time back, *kulhads*, that is, disposable cups made of clay, were suggested as an alternative. But a little thought showed that making these *kulhads* on a large scale would result in the loss of the fertile top-soil. Now disposable paper-cups are being used. What do you think are the advantages of disposable paper-cups over disposable plastic cups?

Activity 15.9

- Search the internet or library to find out what hazardous materials have to be dealt with while disposing of electronic items. How would these materials affect the environment?
- Find out how plastics are recycled. Does the recycling process have any impact on the environment?

Q U E S T I O N S

1. What is ozone and how does it affect any ecosystem?
2. How can you help in reducing the problem of waste disposal? Give any two methods.

What you have learnt

- The various components of an ecosystem are interdependent.
- The producers make the energy from sunlight available to the rest of the ecosystem.
- There is a loss of energy as we go from one trophic level to the next, this limits the number of trophic levels in a food-chain.
- Human activities have an impact on the environment.
- The use of chemicals like CFCs has endangered the ozone layer. Since the ozone layer protects against the ultraviolet radiation from the Sun, this could damage the environment.
- The waste we generate may be biodegradable or non-biodegradable.
- The disposal of the waste we generate is causing serious environmental problems.

E X E R C I S E S

1. Which of the following groups contain only biodegradable items?
 - (a) Grass, flowers and leather
 - (b) Grass, wood and plastic
 - (c) Fruit-peels, cake and lime-juice
 - (d) Cake, wood and grass
2. Which of the following constitute a food-chain?
 - (a) Grass, wheat and mango
 - (b) Grass, goat and human

- (c) Goat, cow and elephant
(d) Grass, fish and goat
3. Which of the following are environment-friendly practices?
- (a) Carrying cloth-bags to put purchases in while shopping
(b) Switching off unnecessary lights and fans
(c) Walking to school instead of getting your mother to drop you on her scooter
(d) All of the above
4. What will happen if we kill all the organisms in one trophic level?
5. Will the impact of removing all the organisms in a trophic level be different for different trophic levels? Can the organisms of any trophic level be removed without causing any damage to the ecosystem?
6. What is biological magnification? Will the levels of this magnification be different at different levels of the ecosystem?
7. What are the problems caused by the non-biodegradable wastes that we generate?
8. If all the waste we generate is biodegradable, will this have no impact on the environment?
9. Why is damage to the ozone layer a cause for concern? What steps are being taken to limit this damage?

Answers

Chapter 1

1. (i) 2. (d) 3. (a)

Chapter 2

1. (d) 2. (b) 3. (d) 4. (c)

Chapter 3

1. (d) 2. (c) 3. (a) 4. (c)

Chapter 6

1. (c) 2. (a) 3. (d) 4. (b)

Chapter 7

1. (d) 2. (b) 3. (d)

Chapter 12

1. (d) 2. (b) 3. (d) 4. (c)
5. Parallel 6. 122.7 m; $\frac{1}{4}$ times
7. 3.33 Ω 8. 4.8 k Ω 9. 0.67 A
10. 4 resistors 12. 110 bulbs
13. 9.2 A, 4.6 A, 18.3 A
14. (i) 8 W; (ii) 8 W
15. 0.73 A
16. 250 W TV set in 1 hour
17. 120 W
18. (b) High resistivity of alloys
(d) inversely.

Chapter 13

1. (d) 2. (c) 3. (a) 4. (d) 5. (c)
6. (a) False (b) True (c) True (d) False
10. vertically downwards
13. (i) The needle will move momentarily in one direction
(ii) The needle will move momentarily but in opposite direction to (i)
(iii) No deflection in the needle would be observed.
15. (a) Right-hand thumb rule, (b) Fleming's left-hand rule, (c) Fleming's right-hand rule.

Chapter 15

1. (a), (c), (d) 2. (b) 3. (d)