



Government of Karnataka

SCIENCE

10

TENTH STANDARD

PART - 2

विद्यया ऽ मृतमश्नुते



एन सी ई आर टी
NCERT

राष्ट्रीय शैक्षिक अनुसंधान और प्रशिक्षण परिषद्
NATIONAL COUNCIL OF EDUCATIONAL RESEARCH AND TRAINING

Karnataka Textbook Society (R.)

100 Feet Ring Road, Banashankari 3rd Stage, Bengaluru - 85

CONTENTS

PART - 2



S. No.	NCERT Chapter Number	Chapter Name	Page No.
I	Chapter 4	Carbon and its Compounds	1 - 22
II	Chapter 5	Periodic Classification of Elements	23 - 36
III	Chapter 8	How do Organisms Reproduce?	37 - 51
IV	Chapter 9	Heredity and Evolution	52 - 69
V	Chapter 10	Light – Reflection and Refraction	70 - 96
VI	Chapter 11	The Human Eye and the Colourful World	97 - 108
VII	Chapter 14	Sources of Energy	109 - 122
VIII	Chapter 16	Sustainable Management of Natural Resources	123 - 137
		Answers	138
Total	8 Chapters		

CHAPTER 4

Carbon and its Compounds

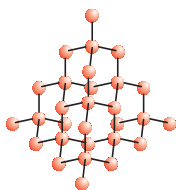

In the last Chapter, we came to know many compounds of importance to us. In this Chapter we will study about some more interesting compounds and their properties. Also, we shall be learning about carbon, an element which is of immense significance to us in both its elemental form and in the combined form.

Activity 4.1

- Make a list of ten things you have used or consumed since the morning.
- Compile this list with the lists made by your classmates and then sort the items into the adjacent Table.
- If there are items which are made up of more than one material, put them into both the relevant columns.

Things made of metal	Things made of glass/clay	Others

Look at the items that come in the last column of the above table filled by you – your teacher will be able to tell you that most of them are made up of compounds of carbon. Can you think of a method to test this? What would be the product if a compound containing carbon is burnt? Do you know of any test to confirm this?

Food, clothes, medicines, books, or many of the things that you listed are all based on this versatile element carbon. In addition, all living structures are carbon based. The amount of carbon present in the earth's crust and in the atmosphere is quite meagre. The earth's crust has only 0.02% carbon in the form of minerals (like carbonates, hydrogen-carbonates, coal and petroleum) and the atmosphere has 0.03% of carbon dioxide. In spite of this small amount of carbon available in nature, the importance of carbon seems to be immense. In this Chapter, we will know about the properties of carbon which make carbon so important to us.

4.1 BONDING IN CARBON – THE COVALENT BOND

In the previous Chapter, we have studied the properties of ionic compounds. We saw that ionic compounds have high melting and boiling

Carbon and its Compounds

points and conduct electricity in solution or in the molten state. We also saw how the nature of bonding in ionic compounds explains these properties. Let us now study the properties of some carbon compounds.

Table 4.1 Melting points and boiling points of some compounds of carbon

Compound	Melting point (K)	Boiling point (K)
Acetic acid (CH ₃ COOH)	290	391
Chloroform (CHCl ₃)	209	334
Ethanol (CH ₃ CH ₂ OH)	156	351
Methane (CH ₄)	90	111

Most carbon compounds are poor conductors of electricity as we have seen in Chapter 2. From the data given in Table 4.1 on the boiling and melting points of the carbon compounds, we find that these compounds have low melting and boiling points as compared to ionic compounds (Chapter 3). We can conclude that the forces of attraction between the molecules are not very

strong. Since these compounds are largely non-conductors of electricity, we can conclude that the bonding in these compounds does not give rise to any ions.

In Class IX, we learnt about the combining capacity of various elements and how it depends on the number of valence electrons. Let us now look at the electronic configuration of carbon. The atomic number of carbon is 6. What would be the distribution of electrons in various shells of carbon? How many valence electrons will carbon have?

We know that the reactivity of elements is explained as their tendency to attain a completely filled outer shell, that is, attain noble gas configuration. Elements forming ionic compounds achieve this by either gaining or losing electrons from the outermost shell. In the case of carbon, it has four electrons in its outermost shell and needs to gain or lose four electrons to attain noble gas configuration. If it were to gain or lose electrons –

- (i) It could gain four electrons forming C⁴⁻ anion. But it would be difficult for the nucleus with six protons to hold on to ten electrons, that is, four extra electrons.
- (ii) It could lose four electrons forming C⁴⁺ cation. But it would require a large amount of energy to remove four electrons leaving behind a carbon cation with six protons in its nucleus holding on to just two electrons.

Carbon overcomes this problem by sharing its valence electrons with other atoms of carbon or with atoms of other elements. Not just carbon, but many other elements form molecules by sharing electrons in this manner. The shared electrons 'belong' to the outermost shells of both the atoms and lead to both atoms attaining the noble gas configuration. Before going on to compounds of carbon, let us look at some simple molecules formed by the sharing of valence electrons.

The simplest molecule formed in this manner is that of hydrogen. As you have learnt earlier, the atomic number of hydrogen is 1. Hence hydrogen has one electron in its K shell and it requires one more electron to fill the K shell. So two hydrogen atoms share their electrons to form a molecule of hydrogen, H_2 . This allows each hydrogen atom to attain the electronic configuration of the nearest noble gas, helium, which has two electrons in its K shell. We can depict this using dots or crosses to represent valence electrons (Fig. 4.1).

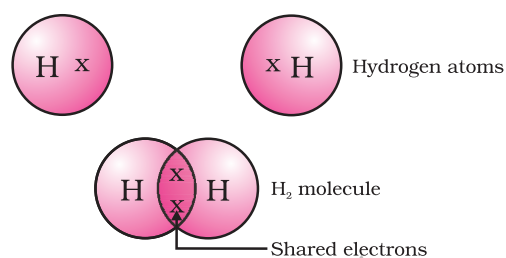

Figure 4.1
A molecule of hydrogen

The shared pair of electrons is said to constitute a single covalent bond between the two hydrogen atoms. A single covalent bond is also represented by a line between the two atoms, as shown in Fig. 4.2.

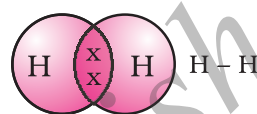

Figure 4.2
Single bond between two hydrogen atoms

The atomic number of chlorine is 17. What would be its electronic configuration and its valency? Chlorine forms a diatomic molecule, Cl_2 . Can you draw the electron dot structure for this molecule? Note that only the valence shell electrons need to be depicted.

In the case of oxygen, we see the formation of a double bond between two oxygen atoms. This is because an atom of oxygen has six electrons in its L shell (the atomic number of oxygen is eight) and it requires two more electrons to complete its octet. So each atom of oxygen shares two electrons with another atom of oxygen to give us the structure shown in Fig. 4.3. The two electrons contributed by each oxygen atom give rise to two shared pairs of electrons. This is said to constitute a double bond between the two atoms.

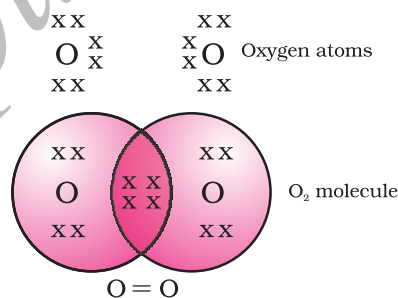

Figure 4.3
Double bond between two oxygen atoms

Can you now depict a molecule of water showing the nature of bonding between one oxygen atom and two hydrogen atoms? Does the molecule have single bonds or double bonds?

What would happen in the case of a diatomic molecule of nitrogen? Nitrogen has the atomic number 7. What would be its electronic configuration and its combining capacity? In order to attain an octet, each nitrogen atom in a molecule of nitrogen contributes three electrons giving rise to three shared pairs of electrons. This is said to constitute a triple bond between the two atoms. The electron dot structure of N_2 and its triple bond can be depicted as in Fig. 4.4.

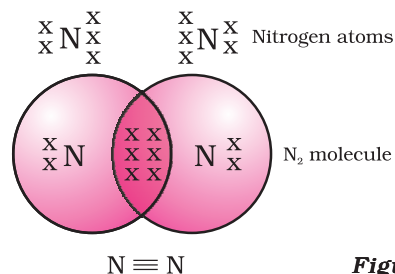

Figure 4.4
Triple bond between two nitrogen atoms

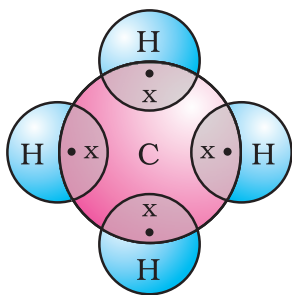

Figure 4.5
Electron dot structure for methane

A molecule of ammonia has the formula NH_3 . Can you draw the electron dot structure for this molecule showing how all four atoms achieve noble gas configuration? Will the molecule have single, double or triple bonds?

Let us now take a look at methane, which is a compound of carbon. Methane is widely used as a fuel and is a major component of bio-gas and Compressed Natural Gas (CNG). It is also one of the simplest compounds formed by carbon. Methane has a formula CH_4 . Hydrogen, as you know, has a valency of 1. Carbon is tetravalent because it has four valence electrons. In order to achieve noble gas configuration, carbon shares these electrons with four atoms of hydrogen as shown in Fig. 4.5.

Such bonds which are formed by the sharing of an electron pair between two atoms are known as covalent bonds. Covalently bonded molecules are seen to have strong bonds within the molecule, but inter-molecular forces are weak. This gives rise to the low melting and boiling points of these compounds. Since the electrons are shared between atoms and no charged particles are formed, such covalent compounds are generally poor conductors of electricity.

Allotropes of carbon

The element carbon occurs in different forms in nature with widely varying physical properties. Both diamond and graphite are formed by carbon atoms, the difference lies in the manner in which the carbon atoms are bonded to one another. In diamond, each carbon atom is bonded to four other carbon atoms forming a rigid three-dimensional structure. In graphite, each carbon atom is bonded to three other carbon atoms in the same plane giving a hexagonal array. One of these bonds is a double-bond, and thus the valency of carbon is satisfied. Graphite structure is formed by the hexagonal arrays being placed in layers one above the other.

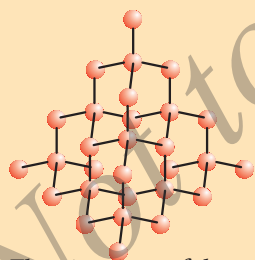

The structure of diamond

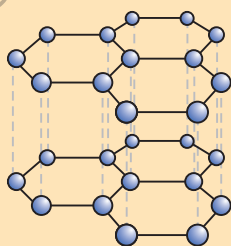

The structure of graphite

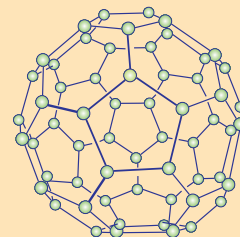

The structure of C-60 Buckminsterfullerene

These two different structures result in diamond and graphite having very different physical properties even though their chemical properties are the same. Diamond is the hardest substance known while graphite is smooth and slippery. Graphite is also a very good conductor of electricity unlike other non-metals that you studied in the previous Chapter.

Diamonds can be synthesised by subjecting pure carbon to very high pressure and temperature. These synthetic diamonds are small but are otherwise indistinguishable from natural diamonds.

Fullerenes form another class of carbon allotropes. The first one to be identified was C-60 which has carbon atoms arranged in the shape of a football. Since this looked like the geodesic dome designed by the US architect Buckminster Fuller, the molecule was named fullerene.

Q U E S T I O N S

1. What would be the electron dot structure of carbon dioxide which has the formula CO_2 ?
2. What would be the electron dot structure of a molecule of sulphur which is made up of eight atoms of sulphur? (**Hint** – The eight atoms of sulphur are joined together in the form of a ring.)

4.2 VERSATILE NATURE OF CARBON

We have seen the formation of covalent bonds by the sharing of electrons in various elements and compounds. We have also seen the structure of a simple carbon compound, methane. In the beginning of the Chapter, we saw how many things we use contain carbon. In fact, we ourselves are made up of carbon compounds. The numbers of carbon compounds whose formulae are known to chemists was recently estimated to be in millions! This outnumbers by a large margin the compounds formed by all the other elements put together. Why is it that this property is seen in carbon and no other element? The nature of the covalent bond enables carbon to form a large number of compounds. Two factors noticed in the case of carbon are –

- (i) Carbon has the unique ability to form bonds with other atoms of carbon, giving rise to large molecules. This property is called catenation. These compounds may have long chains of carbon, branched chains of carbon or even carbon atoms arranged in rings. In addition, carbon atoms may be linked by single, double or triple bonds. Compounds of carbon, which are linked by only single bonds between the carbon atoms are called saturated compounds. Compounds of carbon having double or triple bonds between their carbon atoms are called unsaturated compounds.

No other element exhibits the property of catenation to the extent seen in carbon compounds. Silicon forms compounds with hydrogen which have chains of upto seven or eight atoms, but these compounds are very reactive. The carbon-carbon bond is very strong and hence stable. This gives us the large number of compounds with many carbon atoms linked to each other.

- (ii) Since carbon has a valency of four, it is capable of bonding with four other atoms of carbon or atoms of some other mono-valent element. Compounds of carbon are formed with oxygen, hydrogen, nitrogen, sulphur, chlorine and many other elements giving rise to compounds with specific properties which depend on the elements other than carbon present in the molecule.

Again the bonds that carbon forms with most other elements are very strong making these compounds exceptionally stable. One reason for the formation of strong bonds by carbon is its small size. This enables the nucleus to hold on to the shared pairs of electrons strongly. The bonds formed by elements having bigger atoms are much weaker.

Organic compounds

The two characteristic features seen in carbon, that is, tetravalency and catenation, put together give rise to a large number of compounds. Many have the same non-carbon atom or group of atoms attached to different carbon chains. These compounds were initially extracted from natural substances and it was thought that these carbon compounds or organic compounds could only be formed within a living system. That is, it was postulated that a 'vital force' was necessary for their synthesis. Friedrich Wöhler disproved this in 1828 by preparing urea from ammonium cyanate. But carbon compounds, except for carbides, oxides of carbon, carbonate and hydrogencarbonate salts continue to be studied under organic chemistry.

More to Know!

4.2.1 Saturated and Unsaturated Carbon Compounds

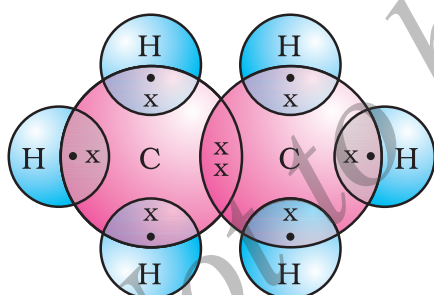

Figure 4.6
(c) Electron dot structure of ethane

We have already seen the structure of methane. Another compound formed between carbon and hydrogen is ethane with a formula of C_2H_6 . In order to arrive at the structure of simple carbon compounds, the first step is to link the carbon atoms together with a single bond (Fig. 4.6a) and then use the hydrogen atoms to satisfy the remaining valencies of carbon (Fig. 4.6b). For example, the structure of ethane is arrived in the following steps –



Step 1

Figure 4.6 (a) Carbon atoms linked together with a single bond

Three valencies of each carbon atom remain unsatisfied, so each is bonded to three hydrogen atoms giving:

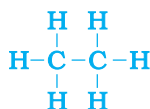

Step 2

Figure 4.6 (b) Each carbon atom bonded to three hydrogen atoms

The electron dot structure of ethane is shown in Fig. 4.6(c).

Can you draw the structure of propane, which has the molecular formula C_3H_8 in a similar manner? You will see that the valencies of all the atoms are satisfied by single bonds between them. Such carbon compounds are called saturated compounds. These compounds are normally not very reactive.

However, another compound of carbon and hydrogen has the formula C_2H_4 and is called ethene. How can this molecule be depicted? We follow the same step-wise approach as above.

Carbon-carbon atoms linked together with a single bond (Step 1).

We see that one valency per carbon atom remains unsatisfied (Step 2). This can be satisfied only if there is a double bond between the two carbons (Step 3).

The electron dot structure for ethene is given in Fig. 4.7. Yet another compound of hydrogen and carbon has the formula C_2H_2 and is called ethyne. Can you draw the electron dot structure for ethyne? How many bonds are necessary between the two carbon atoms in order to satisfy their valencies? Such compounds of carbon having double or triple bonds between the carbon atoms are known as unsaturated carbon compounds and they are more reactive than the saturated carbon compounds.

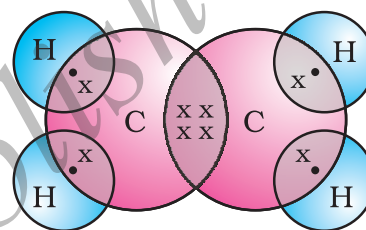
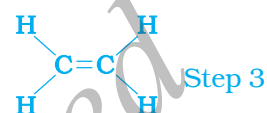
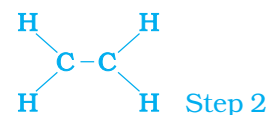

Figure 4.7
Structure of ethene

4.2.2 Chains, Branches and Rings

In the earlier section, we mentioned the carbon compounds methane, ethane and propane, containing respectively 1, 2 and 3 carbon atoms. Such 'chains' of carbon atoms can contain many more carbon atoms. The names and structures of six of these are given in Table 4.2.

Table 4.2 Formulae and structures of saturated compounds of carbon and hydrogen

No. of C atoms	Name	Formula	Structure
1	Methane	CH_4	$\begin{array}{c} H \\ \\ H-C-H \\ \\ H \end{array}$
2	Ethane	C_2H_6	$\begin{array}{c} H & H \\ & \\ H-C & -C-H \\ & \\ H & H \end{array}$
3	Propane	C_3H_8	$\begin{array}{c} H & H & H \\ & & \\ H-C & -C & -C-H \\ & & \\ H & H & H \end{array}$

4	Butane	C_4H_{10}	<pre> H H H H H-C-C-C-C-H H H H H </pre>
5	Pentane	C_5H_{12}	<pre> H H H H H H-C-C-C-C-C-H H H H H H </pre>
6	Hexane	C_6H_{14}	<pre> H H H H H H H-C-C-C-C-C-C-H H H H H H H </pre>

But, let us take another look at butane. If we make the carbon 'skeleton' with four carbon atoms, we see that two different possible 'skeletons' are –



Figure 4.8 (a) Two possible carbon-skeletons

Filling the remaining valencies with hydrogen gives us –

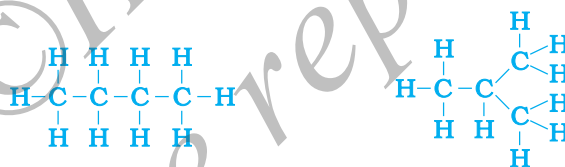

Figure 4.8 (b) Complete molecules for two structures with formula C_4H_{10}

We see that both these structures have the same formula C_4H_{10} . Such compounds with identical molecular formula but different structures are called structural isomers.

In addition to straight and branched carbon chains, some compounds have carbon atoms arranged in the form of a ring. For example, cyclohexane has the formula C_6H_{12} and the following structure –



Figure 4.9 Structure of cyclohexane (a) carbon skeleton (b) complete molecule

Can you draw the electron dot structure for cyclohexane? Straight chain, branched chain and cyclic carbon compounds, all may be saturated or unsaturated. For example, benzene, C_6H_6 , has the following structure –

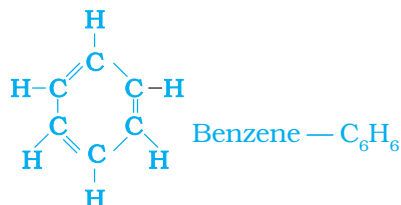

Figure 4.10 Structure of benzene

All these carbon compounds which contain only carbon and hydrogen are called hydrocarbons. Among these, the saturated hydrocarbons are called alkanes. The unsaturated hydrocarbons which contain one or more double bonds are called alkenes. Those containing one or more triple bonds are called alkynes.

4.2.3 Will you be my Friend?

Carbon seems to be a very friendly element. So far we have been looking at compounds containing carbon and hydrogen only. But carbon also forms bonds with other elements such as halogens, oxygen, nitrogen and sulphur.

In a hydrocarbon chain, one or more hydrogens can be replaced by these elements, such that the valency of carbon remains satisfied. In such compounds, the element replacing hydrogen is referred to as a heteroatom. These heteroatoms are also present in some groups as given in Table 4.3. These heteroatoms and the group containing these confer specific properties to the compound, regardless of the length and nature of the carbon chain and hence are called functional groups. Some

Table 4.3 Some functional groups in carbon compounds

Hetero atom	Class of compounds	Formula of functional group
Cl/Br	Halo- (Chloro/bromo) alkane	—Cl, —Br (substitutes for hydrogen atom)
Oxygen	1. Alcohol	—OH
	2. Aldehyde	$\begin{array}{c} \text{H} \\ \\ -\text{C} \\ \\ \text{O} \end{array}$
	3. Ketone	$\begin{array}{c} -\text{C}- \\ \\ \text{O} \end{array}$
	4. Carboxylic acid	$\begin{array}{c} \text{O} \\ \\ -\text{C}-\text{OH} \end{array}$

important functional groups are given in the Table 4.3. Free valency or valencies of the group are shown by the single line. The functional group is attached to the carbon chain through this valency by replacing one hydrogen atom or atoms.

4.2.4 Homologous Series

You have seen that carbon atoms can be linked together to form chains of varying lengths. These chains can be branched also. In addition, hydrogen atom or other atoms on these carbon chains can be replaced by any of the functional groups that we saw above. The presence of a functional group such as alcohol decides the properties of the carbon compound, regardless of the length of the carbon chain. For example, the chemical properties of CH_3OH , $\text{C}_2\text{H}_5\text{OH}$, $\text{C}_3\text{H}_7\text{OH}$ and $\text{C}_4\text{H}_9\text{OH}$ are all very similar. Hence, such a series of compounds in which the same functional group substitutes for hydrogen in a carbon chain is called a homologous series.

Let us look at the homologous series that we saw earlier in Table 4.2. If we look at the formulae of successive compounds, say –

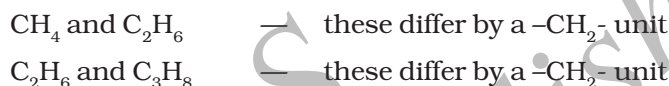

What is the difference between the next pair – propane and butane (C_4H_{10})?

Can you find out the difference in molecular masses between these pairs (the atomic mass of carbon is 12 u and the atomic mass of hydrogen is 1 u)?

Similarly, take the homologous series for alkenes. The first member of the series is ethene which we have already come across in Section 4.2.1. What is the formula for ethene? The succeeding members have the formula C_3H_6 , C_4H_8 and C_5H_{10} . Do these also differ by a $-\text{CH}_2-$ unit? Do you see any relation between the number of carbon and hydrogen atoms in these compounds? The general formula for alkenes can be written as C_nH_{2n} , where $n = 2, 3, 4$. Can you similarly generate the general formula for alkanes and alkynes?

As the molecular mass increases in any homologous series, a gradation in physical properties is seen. This is because the melting and boiling points increase with increasing molecular mass. Other physical properties such as solubility in a particular solvent also show a similar gradation. But the chemical properties, which are determined solely by the functional group, remain similar in a homologous series.

Activity 4.2

- Calculate the difference in the formulae and molecular masses for (a) CH_3OH and $\text{C}_2\text{H}_5\text{OH}$ (b) $\text{C}_2\text{H}_5\text{OH}$ and $\text{C}_3\text{H}_7\text{OH}$, and (c) $\text{C}_3\text{H}_7\text{OH}$ and $\text{C}_4\text{H}_9\text{OH}$.
- Is there any similarity in these three?
- Arrange these alcohols in the order of increasing carbon atoms to get a family. Can we call this family a homologous series?
- Generate the homologous series for compounds containing up to four carbons for the other functional groups given in Table 4.3.

4.2.5 Nomenclature of Carbon Compounds

The names of compounds in a homologous series are based on the name of the basic carbon chain modified by a “prefix” “phrase before” or “suffix” “phrase after” indicating the nature of the functional group. For example, the names of the alcohols taken in Activity 4.2 are methanol, ethanol, propanol and butanol.

Naming a carbon compound can be done by the following method –

- Identify the number of carbon atoms in the compound. A compound having three carbon atoms would have the name propane.
- In case a functional group is present, it is indicated in the name of the compound with either a prefix or a suffix (as given in Table 4.4).
- If the name of the functional group is to be given as a suffix, and the suffix of the functional group begins with a vowel a, e, i, o, u, then the name of the carbon chain is modified by deleting the final ‘e’ and adding the appropriate suffix. For example, a three-carbon chain with a ketone group would be named in the following manner – Propane – ‘e’ = propan + ‘one’ = propanone.
- If the carbon chain is unsaturated, then the final ‘ane’ in the name of the carbon chain is substituted by ‘ene’ or ‘yne’ as given in Table 4.4. For example, a three-carbon chain with a double bond would be called propene and if it has a triple bond, it would be called propyne.

Table 4.4 Nomenclature of organic compounds

Class of compounds	Prefix/Suffix	Example
1. Halo alkane	Prefix-chloro, bromo, etc.	$\begin{array}{c} \text{H} \quad \text{H} \quad \text{H} \\ \quad \quad \\ \text{H}-\text{C}-\text{C}-\text{C}-\text{Cl} \\ \quad \quad \\ \text{H} \quad \text{H} \quad \text{H} \end{array}$ Chloropropane
		$\begin{array}{c} \text{H} \quad \text{H} \quad \text{H} \\ \quad \quad \\ \text{H}-\text{C}-\text{C}-\text{C}-\text{Br} \\ \quad \quad \\ \text{H} \quad \text{H} \quad \text{H} \end{array}$ Bromopropane
2. Alcohol	Suffix - ol	$\begin{array}{c} \text{H} \quad \text{H} \quad \text{H} \\ \quad \quad \\ \text{H}-\text{C}-\text{C}-\text{C}-\text{OH} \\ \quad \quad \\ \text{H} \quad \text{H} \quad \text{H} \end{array}$ Propanol
3. Aldehyde	Suffix - al	$\begin{array}{c} \text{H} \quad \text{H} \quad \text{H} \\ \quad \quad \\ \text{H}-\text{C}-\text{C}-\text{C}=\text{O} \\ \quad \\ \text{H} \quad \text{H} \end{array}$ Propanal

4. Ketone	Suffix - one	$\begin{array}{c} \text{H} \quad \text{H} \\ \quad \\ \text{H}-\text{C}-\text{C}-\text{C}-\text{H} \\ \quad \quad \\ \text{H} \quad \text{O} \quad \text{H} \end{array}$ Propanone
5. Carboxylic acid	Suffix - oic acid	$\begin{array}{c} \text{H} \quad \text{H} \quad \text{O} \\ \quad \quad \\ \text{H}-\text{C}-\text{C}-\text{C}-\text{OH} \\ \quad \\ \text{H} \quad \text{H} \end{array}$ Propanoic acid
6. Alkenes	Suffix - ene	$\begin{array}{c} \text{H} \quad \text{H} \\ \quad \\ \text{H}-\text{C}-\text{C}=\text{C} \\ \quad \quad \\ \text{H} \quad \quad \text{H} \end{array}$ Propene
7. Alkynes	Suffix - yne	$\begin{array}{c} \text{H} \\ \\ \text{H}-\text{C}-\text{C}\equiv\text{C}-\text{H} \\ \\ \text{H} \end{array}$ Propyne

Q U E S T I O N S

- How many structural isomers can you draw for pentane?
- What are the two properties of carbon which lead to the huge number of carbon compounds we see around us?
- What will be the formula and electron dot structure of cyclopentane?
- Draw the structures for the following compounds.
 - Ethanoic acid
 - Bromopentane*
 - Butanone
 - Hexanal.

*Are structural isomers possible for bromopentane?

- How would you name the following compounds?

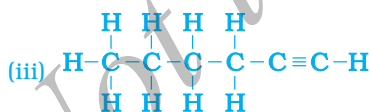

4.3 CHEMICAL PROPERTIES OF CARBON COMPOUNDS

In this section we will be studying about some of the chemical properties of carbon compounds. Since most of the fuels we use are either carbon or its compounds, we shall first study combustion.

4.3.1 Combustion

Carbon, in all its allotropic forms, burns in oxygen to give carbon dioxide along with the release of heat and light. Most carbon compounds also release a large amount of heat and light on burning. These are the oxidation reactions that you learnt about in the first Chapter –

- (i) $C + O_2 \rightarrow CO_2 + \text{heat and light}$
- (ii) $CH_4 + O_2 \rightarrow CO_2 + H_2O + \text{heat and light}$
- (iii) $CH_3CH_2OH + O_2 \rightarrow CO_2 + H_2O + \text{heat and light}$

Balance the latter two reactions like you learnt in the first Chapter.

Activity 4.3

CAUTION: This Activity needs the teacher's assistance.

- Take some carbon compounds (naphthalene, camphor, alcohol) one by one on a spatula and burn them.
- Observe the nature of the flame and note whether smoke is produced.
- Place a metal plate above the flame. Is there a deposition on the plate in case of any of the compounds?

Activity 4.4

- Light a bunsen burner and adjust the air hole at the base to get different types of flames/presence of smoke.
- When do you get a yellow, sooty flame?
- When do you get a blue flame?

Saturated hydrocarbons will generally give a clean flame while unsaturated carbon compounds will give a yellow flame with lots of black smoke. This results in a sooty deposit on the metal plate in Activity 4.3. However, limiting the supply of air results in incomplete combustion of even saturated hydrocarbons giving a sooty flame. The gas/kerosene stove used at home has inlets for air so that a sufficiently oxygen-rich mixture is burnt to give a clean blue flame. If you observe the bottoms of cooking vessels getting blackened, it means that the air holes are blocked and fuel is getting wasted. Fuels such as coal and petroleum have some amount of nitrogen and sulphur in them. Their combustion results in the formation of oxides of sulphur and nitrogen which are major pollutants in the environment.

Why do substances burn with or without a flame?

Have you ever observed either a coal or a wood fire? If not, the next time you get a chance, take close note of what happens when the wood or coal starts to burn. You have seen above that a candle or the LPG in the gas stove burns with a flame. However, you will observe the coal or charcoal in an 'angithi' sometimes just glows red and gives out heat without a flame. This is because a flame is only produced when gaseous substances burn. When wood or charcoal is ignited, the volatile substances present vapourise and burn with a flame in the beginning. A luminous flame is seen when the atoms of the gaseous substance are heated and start to glow. The colour produced by each element is a characteristic property of that element. Try and heat a copper wire in the flame of a gas stove and observe its colour. You have seen that incomplete combustion gives soot which is carbon. On this basis, what will you attribute the yellow colour of a candle flame to?

Do You Know?

Formation of coal and petroleum

Coal and petroleum have been formed from biomass which has been subjected to various biological and geological processes. Coal is the remains of trees, ferns, and other plants that lived millions of years ago. These were crushed into the earth, perhaps by earthquakes or volcanic eruptions. They were pressed down by layers of earth and rock. They slowly decayed into coal. Oil and gas are the remains of millions of tiny plants and animals that lived in the sea. When they died, their bodies sank to the sea bed and were covered by silt. Bacteria attacked the dead remains, turning them into oil and gas under the high pressures they were being subjected to. Meanwhile, the silt was slowly compressed into rock. The oil and gas seeped into the porous parts of the rock, and got trapped like water in a sponge. Can you guess why coal and petroleum are called fossil fuels?

More to Know!

4.3.2 Oxidation

Activity 4.5

- Take about 3 mL of ethanol in a test tube and warm it gently in a water bath.
- Add a 5% solution of alkaline potassium permanganate drop by drop to this solution.
- Does the colour of potassium permanganate persist when it is added initially?
- Why does the colour of potassium permanganate not disappear when excess is added?

You have learnt about oxidation reactions in the first Chapter. Carbon compounds can be easily oxidised on combustion. In addition to this complete oxidation, we have reactions in which alcohols are converted to carboxylic acids



We see that some substances are capable of adding oxygen to others. These substances are known as oxidising agents.

Alkaline potassium permanganate or acidified potassium dichromate are oxidising alcohols to acids, that is, adding oxygen to the starting material. Hence they are known as oxidising agents.

4.3.3 Addition Reaction

Unsaturated hydrocarbons add hydrogen in the presence of catalysts such as palladium or nickel to give saturated hydrocarbons. Catalysts are substances that cause a reaction to occur or proceed at a different rate without the reaction itself being affected. This reaction is commonly used in the hydrogenation of vegetable oils using a nickel catalyst. Vegetable oils generally have long unsaturated carbon chains while animal fats have saturated carbon chains.

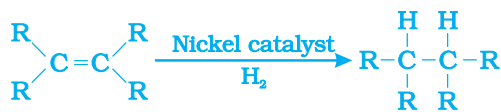

You must have seen advertisements stating that some vegetable oils are 'healthy'. Animal fats generally contain saturated fatty acids which are said to be harmful for health. Oils containing unsaturated fatty acids should be chosen for cooking.

4.3.4 Substitution Reaction

Saturated hydrocarbons are fairly unreactive and are inert in the presence of most reagents. However, in the presence of sunlight, chlorine is added to hydrocarbons in a very fast reaction. Chlorine can replace the hydrogen atoms one by one. It is called a substitution reaction because one type of atom or a group of atoms takes the place of another. A number of products are usually formed with the higher homologues of alkanes.



Q U E S T I O N S

1. Why is the conversion of ethanol to ethanoic acid an oxidation reaction?
2. A mixture of oxygen and ethyne is burnt for welding. Can you tell why a mixture of ethyne and air is not used?

4.4 SOME IMPORTANT CARBON COMPOUNDS – ETHANOL AND ETHANOIC ACID

Many carbon compounds are invaluable to us. But here we shall study the properties of two commercially important compounds – ethanol and ethanoic acid.

4.4.1 Properties of Ethanol

Ethanol is a liquid at room temperature (refer to Table 4.1 for the melting and boiling points of ethanol). Ethanol is commonly called alcohol and is the active ingredient of all alcoholic drinks. In addition, because it is a good solvent, it is also used in medicines such as tincture iodine, cough syrups, and many tonics. Ethanol is also soluble in water in all proportions. Consumption of small quantities of dilute ethanol causes drunkenness. Even though this practice is condemned, it is a socially widespread practice. However, intake of even a small quantity of pure ethanol (called absolute alcohol) can be lethal. Also, long-term consumption of alcohol leads to many health problems.

Reactions of Ethanol

(i) Reaction with sodium –

Activity 4.6

Teacher's demonstration –

- Drop a small piece of sodium, about the size of a couple of grains of rice, into ethanol (absolute alcohol).
- What do you observe?
- How will you test the gas evolved?

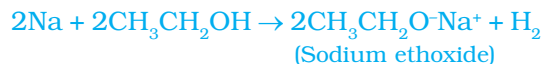

Alcohols react with sodium leading to the evolution of hydrogen. With ethanol, the other product is sodium ethoxide. Can you recall which other substances produce hydrogen on reacting with metals?

(ii) Reaction to give unsaturated hydrocarbon: Heating ethanol at 443 K with excess concentrated sulphuric acid results in the dehydration of ethanol to give ethene –



The concentrated sulphuric acid can be regarded as a dehydrating agent which removes water from ethanol.

Do You Know?

How do alcohols affect living beings?

When large quantities of ethanol are consumed, it tends to slow metabolic processes and to depress the central nervous system. This results in lack of coordination, mental confusion, drowsiness, lowering of the normal inhibitions, and finally stupor. The individual may feel relaxed without realising that his sense of judgement, sense of timing, and muscular coordination have been seriously impaired. Unlike ethanol, intake of methanol in very small quantities can cause death. Methanol is oxidised to methanal in the liver. Methanal reacts rapidly with the components of cells. It coagulates the protoplasm, in much the same way an egg is coagulated by cooking. Methanol also affects the optic nerve, causing blindness. Ethanol is an important industrial solvent. To prevent the misuse of ethanol produced for industrial use, it is made unfit for drinking by adding poisonous substances like methanol to it. Dyes are also added to colour the alcohol blue so that it can be identified easily. This is called denatured alcohol.

Alcohol as a fuel

Sugarcane plants are one of the most efficient convertors of sunlight into chemical energy. Sugarcane juice can be used to prepare molasses which is fermented to give alcohol (ethanol). Some countries now use alcohol as an additive in petrol since it is a cleaner fuel which gives rise to only carbon dioxide and water on burning in sufficient air (oxygen).

More to Know!

4.4.2 Properties of Ethanoic Acid

Ethanoic acid is commonly called acetic acid and belongs to a group of acids called carboxylic acids. 5-8% solution of acetic acid in water is called vinegar and is used widely as a preservative in pickles. The melting point of pure ethanoic acid is 290 K and hence it often freezes during winter in cold climates. This gave rise to its name glacial acetic acid.

The group of organic compounds called carboxylic acids are obviously characterised by their acidic nature. However, unlike mineral acids like HCl, which are completely ionised, carboxylic acids are weak acids.

Activity 4.8

- Take 1 mL ethanol (absolute alcohol) and 1 mL glacial acetic acid along with a few drops of concentrated sulphuric acid in a test tube.
- Warm in a water-bath for at least five minutes as shown in Fig. 4.11.
- Pour into a beaker containing 20-50 mL of water and smell the resulting mixture.

Reactions of ethanoic acid:

- (i) *Esterification reaction:* Esters are most commonly formed by reaction of an acid and an alcohol. Ethanoic acid reacts with absolute ethanol in the presence of an acid catalyst to give an ester –

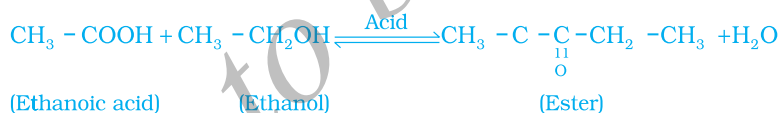

Generally, esters are sweet-smelling substances. These are used in making perfumes and as flavouring agents. On treating with sodium hydroxide, which is an alkali, the ester is converted back to alcohol and sodium salt of carboxylic acid. This reaction is known as saponification because it is used in the preparation of soap. Soaps are sodium or potassium salts of long chain carboxylic acid.

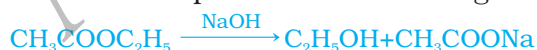

- (ii) *Reaction with a base:* Like mineral acids, ethanoic acid reacts with a base such as sodium hydroxide to give a salt (sodium ethanoate or commonly called sodium acetate) and water:



Activity 4.7

- Compare the pH of dilute acetic acid and dilute hydrochloric acid using both litmus paper and universal indicator.
- Are both acids indicated by the litmus test?
- Does the universal indicator show them as equally strong acids?

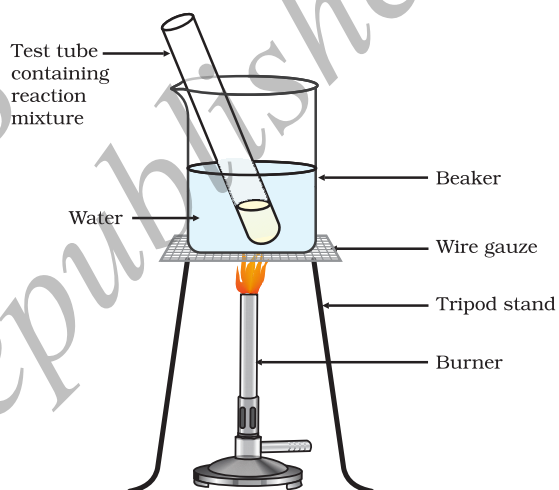

Figure 4.11
Formation of ester

How does ethanoic acid react with carbonates and hydrogencarbonates?

Let us perform an activity to find out.

Activity 4.9

- Set up the apparatus as shown in Chapter 2, Activity 2.5.
- Take a spatula full of sodium carbonate in a test tube and add 2 mL of dilute ethanoic acid.
- What do you observe?
- Pass the gas produced through freshly prepared lime-water. What do you observe?
- Can the gas produced by the reaction between ethanoic acid and sodium carbonate be identified by this test?
- Repeat this Activity with sodium hydrogencarbonate instead of sodium carbonate.

(iii) *Reaction with carbonates and hydrogencarbonates:* Ethanoic acid reacts with carbonates and hydrogencarbonates to give rise to a salt, carbon dioxide and water. The salt produced is commonly called sodium acetate.



Q U E S T I O N S

1. How would you distinguish experimentally between an alcohol and a carboxylic acid?
2. What are oxidising agents?



4.5 SOAPS AND DETERGENTS

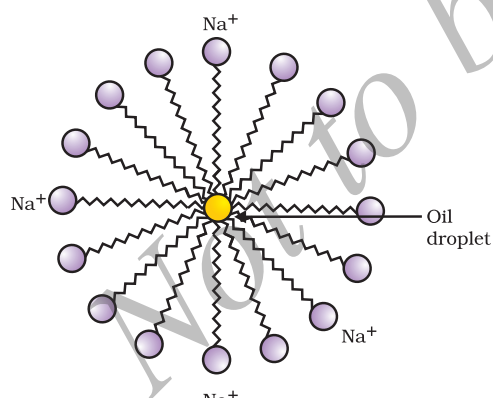

Figure 4.12
Formation of micelles

Activity 4.10

- Take about 10 mL of water each in two test tubes.
- Add a drop of oil (cooking oil) to both the test tubes and label them as A and B.
- To test tube B, add a few drops of soap solution.
- Now shake both the test tubes vigorously for the same period of time.
- Can you see the oil and water layers separately in both the test tubes immediately after you stop shaking them?
- Leave the test tubes undisturbed for some time and observe. Does the oil layer separate out? In which test tube does this happen first?

This activity demonstrates the effect of soap in cleaning. Most dirt is oily in nature and as you know, oil does not dissolve in water. The molecules of soap are sodium or potassium salts of long-chain carboxylic acids. The ionic-end of soap interacts with water while the carbon chain interacts with oil. The soap molecules, thus form structures called micelles (see Fig. 4.12) where one end of the molecules is towards the oil droplet while the ionic-end faces outside. This forms an emulsion in water. The soap micelle thus helps in pulling out the dirt in water and we can wash our clothes clean (Fig. 4.13).

Can you draw the structure of the micelle that would be formed if you dissolve soap in a hydrocarbon?

Micelles

Soaps are molecules in which the two ends have differing properties, one is hydrophilic, that is, it interacts with water, while the other end is hydrophobic, that is, it interacts with hydrocarbons. When soap is at the surface of water, the hydrophobic 'tail' of soap will not be soluble in water and the soap will align along the surface of water with the ionic end in water and the hydrocarbon 'tail' protruding out of water.

More to Know!

Inside water, these molecules have a unique orientation that keeps the hydrocarbon portion out of the water. Thus, clusters of molecules in which the hydrophobic tails are in the interior of the cluster and the ionic ends are on the surface of the cluster. This formation is called a micelle. Soap in the form of a micelle is able to clean, since the oily dirt will be collected in the centre of the micelle. The micelles stay in solution as a colloid and will not come together to precipitate because of ion-ion repulsion. Thus, the dirt suspended in the micelles is also easily rinsed away. The soap micelles are large enough to scatter light. Hence a soap solution appears cloudy.

Figure 4.13 Effect of soap in cleaning

Activity 4.11

- Take about 10 mL of distilled water (or rain water) and 10 mL of hard water (from a tubewell or hand-pump) in separate test tubes.
- Add a couple of drops of soap solution to both.
- Shake the test tubes vigorously for an equal period of time and observe the amount of foam formed.
- In which test tube do you get more foam?
- In which test tube do you observe a white curdy precipitate?

Note for the teacher: If hard water is not available in your locality, prepare some hard water by dissolving hydrogencarbonates/sulphates/chlorides of calcium or magnesium in water.

Activity 4.12

- Take two test tubes with about 10 mL of hard water in each.
- Add five drops of soap solution to one and five drops of detergent solution to the other.
- Shake both test tubes for the same period.
- Do both test tubes have the same amount of foam?
- In which test tube is a curdy solid formed?

Have you ever observed while bathing that foam is formed with difficulty and an insoluble substance (scum) remains after washing with water? This is caused by the reaction of soap with the calcium and magnesium salts, which cause the hardness of water. Hence you need to use a larger amount of soap. This problem is overcome by using another class of compounds called detergents as cleansing agents. Detergents are generally sodium salts of sulphonic acids or ammonium salts with chlorides or bromides ions, etc. Both have long hydrocarbon chain. The charged ends of these compounds do not form insoluble precipitates with the calcium and magnesium ions in hard water. Thus, they remain effective in hard water. Detergents are usually used to make shampoos and products for cleaning clothes.

Q U E S T I O N S

1. Would you be able to check if water is hard by using a detergent?
2. People use a variety of methods to wash clothes. Usually after adding the soap, they 'beat' the clothes on a stone, or beat it with a paddle, scrub with a brush or the mixture is agitated in a washing machine. Why is agitation necessary to get clean clothes?



What you have learnt

- Carbon is a versatile element that forms the basis for all living organisms and many of the things we use.
- This large variety of compounds is formed by carbon because of its tetravalency and the property of catenation that it exhibits.
- Covalent bonds are formed by the sharing of electrons between two atoms so that both can achieve a completely filled outermost shell.
- Carbon forms covalent bonds with itself and other elements such as hydrogen, oxygen, sulphur, nitrogen and chlorine.
- Carbon also forms compounds containing double and triple bonds between carbon atoms. These carbon chains may be in the form of straight chains, branched chains or rings.
- The ability of carbon to form chains gives rise to a homologous series of compounds in which the same functional group is attached to carbon chains of different lengths.
- The functional groups such as alcohols, aldehydes, ketones and carboxylic acids bestow characteristic properties to the carbon compounds that contain them.
- Carbon and its compounds are some of our major sources of fuels.
- Ethanol and ethanoic acid are carbon compounds of importance in our daily lives.
- The action of soaps and detergents is based on the presence of both hydrophobic and hydrophilic groups in the molecule and this helps to emulsify the oily dirt and hence its removal.

EXERCISES

1. Ethane, with the molecular formula C_2H_6 has
 - (a) 6 covalent bonds.
 - (b) 7 covalent bonds.
 - (c) 8 covalent bonds.
 - (d) 9 covalent bonds.
2. Butanone is a four-carbon compound with the functional group
 - (a) carboxylic acid.
 - (b) aldehyde.
 - (c) ketone.
 - (d) alcohol.
3. While cooking, if the bottom of the vessel is getting blackened on the outside, it means that
 - (a) the food is not cooked completely.
 - (b) the fuel is not burning completely.
 - (c) the fuel is wet.
 - (d) the fuel is burning completely.

4. Explain the nature of the covalent bond using the bond formation in CH_3Cl .
5. Draw the electron dot structures for
 - (a) ethanoic acid.
 - (b) H_2S .
 - (c) propanone.
 - (d) F_2 .
6. What is an homologous series? Explain with an example.
7. How can ethanol and ethanoic acid be differentiated on the basis of their physical and chemical properties?
8. Why does micelle formation take place when soap is added to water? Will a micelle be formed in other solvents such as ethanol also?
9. Why are carbon and its compounds used as fuels for most applications?
10. Explain the formation of scum when hard water is treated with soap.
11. What change will you observe if you test soap with litmus paper (red and blue)?
12. What is hydrogenation? What is its industrial application?
13. Which of the following hydrocarbons undergo addition reactions:
 C_2H_6 , C_3H_8 , C_3H_6 , C_2H_2 and CH_4 .
14. Give a test that can be used to differentiate between saturated and unsaturated hydrocarbons.
15. Explain the mechanism of the cleaning action of soaps.

Group Activity

- I Use molecular model kits to make models of the compounds you have learnt in this Chapter.
- II
 - Take about 20 mL of castor oil/cotton seed oil/linseed oil/soyabean oil in a beaker. Add 30 mL of 20% sodium hydroxide solution. Heat the mixture with continuous stirring for a few minutes till the mixture thickens. Add 5-10 g of common salt to this. Stir the mixture well and allow it to cool.
 - You can cut out the soap in fancy shapes. You can also add perfume to the soap before it sets.



CHAPTER 5

Periodic Classification of Elements



In Class IX we have learnt that matter around us is present in the form of elements, compounds and mixtures and the elements contain atoms of only one type. Do you know how many elements are known till date? At present, 118 elements are known to us. All these have different properties. Out of these 118, only 94 are naturally occurring.

As different elements were being discovered, scientists gathered more and more information about the properties of these elements. They found it difficult to organise all that was known about the elements. They started looking for some pattern in their properties, on the basis of which they could study such a large number of elements with ease.

5.1 MAKING ORDER OUT OF CHAOS – EARLY ATTEMPTS AT THE CLASSIFICATION OF ELEMENTS

We have been learning how various things or living beings can be classified on the basis of their properties. Even in other situations, we come across instances of organisation based on some properties. For example, in a shop, soaps are kept together at one place while biscuits are kept together elsewhere. Even among soaps, bathing soaps are stacked separately from washing soaps. Similarly, scientists made several attempts to classify elements according to their properties and obtain an orderly arrangement out of chaos.

The earliest attempt to classify the elements resulted in grouping the then known elements as metals and non-metals. Later further classifications were tried out as our knowledge of elements and their properties increased.

5.1.1 Döbereiner's Triads

In the year 1817, Johann Wolfgang Döbereiner, a German chemist, tried to arrange the elements with similar properties into groups. He identified some groups having three elements each. So he called these groups 'triads'. Döbereiner showed that when the three elements in a



Figure 5.1

Imagine you and your friends have found pieces of an old map to reach a treasure. Would it be easy or chaotic to find the way to the treasure? Similar chaos was there in Chemistry as elements were known but there was no clue as to how to classify and study about them.

triad were written in the order of increasing atomic masses; the atomic mass of the middle element was roughly the average of the atomic masses of the other two elements.

For example, take the triad consisting of lithium (Li), sodium (Na) and potassium (K) with the respective atomic masses 6.9, 23.0 and 39.0. What is the average of the atomic masses of Li and K? How does this compare with the atomic mass of Na?

Given below (Table 5.1) are some groups of three elements. These elements are arranged downwards in order of increasing atomic masses. Can you find out which of these groups form Döbereiner triads?

Table 5.1

Group A element	Atomic mass	Group B element	Atomic mass	Group C elements	Atomic mass
N	14.0	Ca	40.1	Cl	35.5
P	31.0	Sr	87.6	Br	79.9
As	74.9	Ba	137.3	I	126.9

You will find that groups B and C form Döbereiner triads. Döbereiner could identify only three triads from the elements known at that time (Table 5.2). Hence, this system of classification into triads was not found to be useful.

Table 5.2
Döbereiner's triads

Li	Ca	Cl
Na	Sr	Br
K	Ba	I

Johann Wolfgang Döbereiner (1780-1849)

Johann Wolfgang Döbereiner studied as a pharmacist at Münchberg in Germany, and then studied chemistry at Strasbourg. Eventually he became a professor of chemistry and pharmacy at the University of Jena. Döbereiner made the first observations on platinum as a catalyst and discovered similar triads of elements which led to the development of the Periodic Table of elements.



5.1.2 Newlands' Law of Octaves

The attempts of Döbereiner encouraged other chemists to correlate the properties of elements with their atomic masses. In 1866, John Newlands, an English scientist, arranged the then known elements in the order of increasing atomic masses. He started with the element having the lowest atomic mass (hydrogen) and ended at thorium which was the 56th element. He found that every eighth element had properties similar to that of the first. He compared this to the octaves found in music. Therefore, he called it the 'Law of Octaves'. It is known as 'Newlands' Law of Octaves'. In Newlands' Octaves, the properties of lithium and sodium were found to be the same. Sodium is the eighth element after lithium. Similarly, beryllium and magnesium resemble each other. A part of the original form of Newlands' Octaves is given in Table 5.3.

Table 5.3 Newlands' Octaves

Notes of music:	sa (do)	re (re)	ga (mi)	ma (fa)	pa (so)	da (la)	ni (ti)
	H	Li	Be	B	C	N	O
	F	Na	Mg	Al	Si	P	S
	Cl	K	Ca	Cr	Ti	Mn	Fe
	Co and Ni	Cu	Zn	Y	In	As	Se
	Br	Rb	Sr	Ce and La	Zr	—	—

Do You Know?**Are you familiar with musical notes?**

In the Indian system of music, there are seven musical notes in a scale – *sa, re, ga, ma, pa, da, ni*. In the west, they use the notations – *do, re, mi, fa, so, la, ti*. The notes in a scale are separated by whole and half-step frequency intervals of tones and semitones. A musician uses these notes for composing the music of a song. Naturally, there must be some repetition of notes. Every eighth note is similar to the first one and it is the first note of the next scale.

- It was found that the Law of Octaves was applicable only upto calcium, as after calcium every eighth element did not possess properties similar to that of the first.
- It was assumed by Newlands that only 56 elements existed in nature and no more elements would be discovered in the future. But, later on, several new elements were discovered, whose properties did not fit into the Law of Octaves.
- In order to fit elements into his Table, Newlands adjusted two elements in the same slot, but also put some unlike elements under the same note. Can you find examples of these from Table 5.3? Note that cobalt and nickel are in the same slot and these are placed in the same column as fluorine, chlorine and bromine which have very different properties than these elements. Iron, which resembles cobalt and nickel in properties, has been placed far away from these elements. With the discovery of noble gases, the Law of Octaves became irrelevant. Thus, Newlands' Law of Octaves worked well with lighter elements only.

Q U E S T I O N S

- Did Döbereiner's triads also exist in the columns of Newlands' Octaves? Compare and find out.
- What were the limitations of Döbereiner's classification?
- What were the limitations of Newlands' Law of Octaves?

**5.2 MAKING ORDER OUT OF CHAOS – MENDELÉEV'S PERIODIC TABLE**

Even after the rejection of Newlands' Law of Octaves, many scientists continued to search for a pattern that correlated the properties of elements with their atomic masses.

The main credit for classifying elements goes to Dmitri Ivanovich Mendeléeu, a Russian chemist. He was the most important contributor to the early development of a Periodic Table of elements wherein the elements were arranged on the basis of their fundamental property, the atomic mass, and also on the similarity of chemical properties.

Dmitri Ivanovich Mendeléeu (1834-1907)

Dmitri Ivanovich Mendeléeu was born in Tobolsk in Western Siberia, Russia on 8 February 1834. After his early education, Mendeléeu could join a university only due to the efforts of his mother. Dedicating his investigations to his mother he wrote, "She instructed with example, corrected with love and travelled with me to places spending her last resources and strength. She knew that with the aid of science without violence, with love but firmness, all superstitions, untruth and errors can be removed." The arrangement of elements he proposed is called Mendeléeu's Periodic Table. The Periodic Table proved to be the unifying principle in chemistry. It was the motivation for the discovery of some new elements.

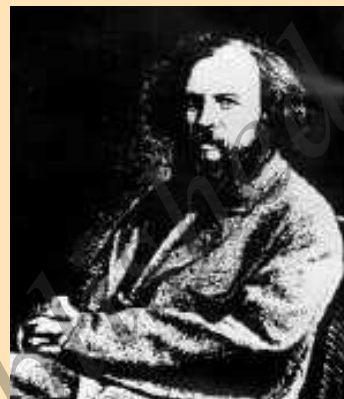

When Mendeléeu started his work, 63 elements were known. He examined the relationship between the atomic masses of the elements and their physical and chemical properties. Among chemical properties, Mendeléeu concentrated on the compounds formed by elements with oxygen and hydrogen. He selected hydrogen and oxygen as they are very reactive and formed compounds with most elements. The formulae of the hydrides and oxides formed by an element were treated as one of the basic properties of an element for its classification. He then took 63 cards and on each card he wrote down the properties of one element. He sorted out the elements with similar properties and pinned the cards together on a wall. He observed that most of the elements got a place in a Periodic Table and were arranged in the order of their increasing atomic masses. It was also observed that there occurs a periodic recurrence of elements with similar physical and chemical properties. On this basis, Mendeléeu formulated a Periodic Law, which states that 'the properties of elements are the periodic function of their atomic masses'.

Mendeléeu's Periodic Table contains vertical columns called 'groups' and horizontal rows called 'periods' (Table 5.4).

Table 5.4 MendeléeV's Periodic Table

Group	I		II		III		IV		V		VI		VII		VIII		
Oxide Hydride	R ₂ O RH		RO RH ₂		R ₂ O ₃ RH ₃		RO ₂ RH ₄		R ₂ O ₅ RH ₃		RO ₃ RH ₂		R ₂ O ₇ RH		RO ₄		
Periods ↓	A	B	A	B	A	B	A	B	A	B	A	B	A	B	Transition series		
1	H 1.008																
2	Li 6.939		Be 9.012		B 10.81		C 12.011		N 14.007		O 15.999		F 18.998				
3	Na 22.99		Mg 24.31		Al 29.98		Si 28.09		P 30.974		S 32.06		Cl 35.453				
4 First series:	K 39.102		Ca 40.08		Sc 44.96		Ti 47.90		V 50.94		Cr 50.20		Mn 54.94		Fe 55.85	Co 58.93	Ni 58.71
Second series:	Cu 63.54		Zn 65.37		Ga 69.72		Ge 72.59		As 74.92		Se 78.96		Br 79.909				
5 First series:	Rb 85.47		Sr 87.62		Y 88.91		Zr 91.22		Nb 92.91		Mo 95.94		Tc 99		Ru 101.07	Rh 102.91	Pd 106.4
Second series:	Ag 107.87		Cd 112.40		In 114.82		Sn 118.69		Sb 121.75		Te 127.60		I 126.90				
6 First series:	Cs 132.90		Ba 137.34		La 138.91		Hf 178.49		Ta 180.95		W 183.85				Os 190.2	Ir 192.2	Pt 195.09
Second series:	Au 196.97		Hg 200.59		Tl 204.37		Pb 207.19		Bi 208.98								

MendeléeV's Periodic Table was published in a German journal in 1872. In the formula for oxides and hydrides at the top of the columns, the letter 'R' is used to represent any of the elements in the group. Note the way formulae are written. For example, the hydride of carbon, CH₄, is written as RH₄ and the oxide CO₂, as RO₂.

5.2.1 Achievements of MendeléeV's Periodic Table

While developing the Periodic Table, there were a few instances where MendeléeV had to place an element with a slightly greater atomic mass before an element with a slightly lower atomic mass. The sequence was inverted so that elements with similar properties could be grouped together. For example, cobalt (atomic mass 58.9) appeared before nickel (atomic mass 58.7). Looking at Table 5.4, can you find out one more such anomaly?

Further, MendeléeV left some gaps in his Periodic Table. Instead of looking upon these gaps as defects, MendeléeV boldly predicted the existence of some elements that had not been discovered at that time. MendeléeV named them by prefixing a Sanskrit numeral, *Eka* (one) to the name of preceding element in the same group. For instance, scandium, gallium and germanium, discovered later, have properties

similar to *Eka*-boron, *Eka*-aluminium and *Eka*-silicon, respectively. The properties of *Eka*-Aluminium predicted by Mendeléeve and those of the element, gallium which was discovered later and replaced *Eka*-aluminium, are listed as follows (Table 5.5).

Table 5.5 Properties of *eka*-aluminium and gallium

Property	<i>Eka</i> -aluminium	Gallium
Atomic Mass	68	69.7
Formula of Oxide	E_2O_3	Ga_2O_3
Formula of Chloride	ECl_3	$GaCl_3$

This provided convincing evidence for both the correctness and usefulness of Mendeléeve's Periodic Table. Further, it was the extraordinary success of Mendeléeve's prediction that led chemists not only to accept his Periodic Table but also recognise him, as the originator of the concept on which it is based. Noble gases like helium (He), neon (Ne) and argon (Ar) have been mentioned in many a context before this. These gases were discovered very late because they are very inert and present in extremely low concentrations in our atmosphere. One of the strengths of Mendeléeve's Periodic Table was that, when these gases were discovered, they could be placed in a new group without disturbing the existing order.

5.2.2 Limitations of Mendeléeve's Classification

Electronic configuration of hydrogen resembles that of alkali metals. Like alkali metals, hydrogen combines with halogens, oxygen and sulphur to form compounds having similar formulae, as shown in the examples here.

Compounds of H	Compounds of Na
HCl	NaCl
H_2O	Na_2O
H_2S	Na_2S

On the other hand, just like halogens, hydrogen also exists as diatomic molecules and it combines with metals and non-metals to form covalent compounds.

Activity 5.1

- Looking at its resemblance to alkali metals and the halogen family, try to assign hydrogen a correct position in Mendeléeve's Periodic Table.
- To which group and period should hydrogen be assigned?

Certainly, no fixed position can be given to hydrogen in the Periodic Table. This was the first limitation of Mendeléeve's Periodic Table. He could not assign a correct position to hydrogen in his Table.

Isotopes were discovered long after Mendeléeve had proposed his periodic classification of elements. Let us recall that isotopes of an element have similar chemical properties, but different atomic masses.

Activity 5.2

- Consider the isotopes of chlorine, Cl-35 and Cl-37.
- Would you place them in different slots because their atomic masses are different?
- Or would you place them in the same position because their chemical properties are the same?

Thus, isotopes of all elements posed a challenge to Mendeleev's Periodic Law. Another problem was that the atomic masses do not increase in a regular manner in going from one element to the next. So it was not possible to predict how many elements could be discovered between two elements — especially when we consider the heavier elements.

Q U E S T I O N S

1. Use Mendeléeev's Periodic Table to predict the formulae for the oxides of the following elements:
K, C, Al, Si, Ba.
2. Besides gallium, which other elements have since been discovered that were left by Mendeléeev in his Periodic Table? (any two)
3. What were the criteria used by Mendeléeev in creating his Periodic Table?
4. Why do you think the noble gases are placed in a separate group?

5.3 MAKING ORDER OUT OF CHAOS – THE MODERN PERIODIC TABLE

In 1913, Henry Moseley showed that the atomic number (symbolised as Z) of an element is a more fundamental property than its atomic mass. Accordingly, Mendeléeev's Periodic Law was modified and atomic number was adopted as the basis of Modern Periodic Table and the Modern Periodic Law can be stated as follows:

'Properties of elements are a periodic function of their atomic number.'

Let us recall that the atomic number gives us the number of protons in the nucleus of an atom and this number increases by one in going from one element to the next. Elements, when arranged in order of increasing atomic number, lead us to the classification known as the Modern Periodic Table (Table 5.6). Prediction of properties of elements could be made with more precision when elements were arranged on the basis of increasing atomic number.

Activity 5.3

- How were the positions of cobalt and nickel resolved in the Modern Periodic Table?
- How were the positions of isotopes of various elements decided in the Modern Periodic Table?
- Is it possible to have an element with atomic number 1.5 placed between hydrogen and helium?
- Where do you think should hydrogen be placed in the Modern Periodic Table?

Table 5.6 Modern Periodic Table

Metals Metalloids Non-metals

The zigzag line separates the metals from the non-metals.

GROUP NUMBER

GROUP NUMBER

GROUP NUMBER

18

P
E
R
I
O
D
S

1	1 H Hydrogen 1.0	2											13	14	15	16	17	2	He Helium 4.0
2	3 Li Lithium 6.9	4 Be Beryllium 9.0											5 B Boron 10.8	6 C Carbon 12.0	7 N Nitrogen 14.0	8 O Oxygen 16.0	9 F Fluorine 19.0	10 Ne Neon 20.2	
3	11 Na Sodium 23.0	12 Mg Magnesium 24.3	3	4	5	6	7	8	9	10	11	12	13 Al Aluminium 27.0	14 Si Silicon 28.1	15 P Phosphorus 31.0	16 S Sulphur 32.1	17 Cl Chlorine 35.5	18 Ar Argon 39.9	
4	19 K Potassium 39.1	20 Ca Calcium 40.1	21 Sc Scandium 45.0	22 Ti Titanium 47.8	23 V Vanadium 50.9	24 Cr Chromium 52.0	25 Mn Manganese 54.9	26 Fe Iron 55.9	27 Co Cobalt 58.9	28 Ni Nickel 58.7	29 Cu Copper 63.5	30 Zn Zinc 65.4	31 Ga Gallium 69.7	32 Ge Germanium 72.6	33 As Arsenic 74.9	34 Se Selenium 79.0	35 Br Bromine 79.9	36 Kr Krypton 83.8	
5	37 Rb Rubidium 85.5	38 Sr Strontium 87.6	39 Y Yttrium 88.9	40 Zr Zirconium 91.2	41 Nb Niobium 92.9	42 Mo Molybdenum 95.9	43 Tc Technetium (99)	44 Ru Ruthenium 101.1	45 Rh Rhodium 102.3	46 Pd Palladium 106.4	47 Ag Silver 107.9	48 Cd Cadmium 112.4	49 In Indium 114.8	50 Sn Tin 118.7	51 Sb Antimony 121.8	52 Te Tellurium 127.6	53 I Iodine 126.9	54 Xe Xenon 131.3	
6	55 Cs Caesium 132.9	56 Ba Barium 137.3	57 La* Lanthanum 138.9	72 Hf Hafnium 178.5	73 Ta Tantalum 181.0	74 W Tungsten 183.9	75 Re Rhenium 186.2	76 Os Osmium 190.2	77 Ir Iridium 192.2	78 Pt Platinum 195.1	79 Au Gold 197.0	80 Hg Mercury 200.6	81 Tl Thallium 204.4	82 Pb Lead 207.2	83 Bi Bismuth 209.0	84 Po Polonium (210)	85 At Astatine (210)	86 Rn Radon (222)	
7	87 Fr Francium (223)	88 Ra Radium (226)	89 Ac** Actinium (227)	104 Rf (Rutherfordium) (267)	105 Db Dubnium (268)	106 Sg Seaborgium (269)	107 Bh Bohrium (270)	108 Hs Hassium (277)	109 Mt Meitnerium (278)	110 Ds Darmstadtium (281)	111 Rg Roentgenium (282)	112 Cn Copernicium (285)	113 Nh (Nihonium) (286)	114 Fl Flerovium (289)	115 Mc Moscovium (290)	116 Lv Livermorium (293)	117 Ts Tennessine (294)	118 Og Oganesson (294)	

* Lanthanoides

58 Ce Cerium 140.1	59 Pr Praseodymium 140.9	60 Nd Neodymium 144.2	61 Pm Promethium (145)	62 Sm Samarium 150.4	63 Eu Europium 152.0	64 Gd Gadolinium 157.3	65 Tb Terbium 158.9	66 Dy Dysprosium 162.5	67 Ho Holmium 164.9	68 Er Erbium 167.3	69 Tm Thulium 168.9	70 Yb Ytterbium 173.0	71 Lu Lutetium 175.5
-----------------------------	-----------------------------------	--------------------------------	---------------------------------	-------------------------------	-------------------------------	---------------------------------	------------------------------	---------------------------------	------------------------------	-----------------------------	------------------------------	--------------------------------	-------------------------------

** Actinoides

90 Th Thorium 232.0	91 Pa Protactinium (231)	92 U Uranium 238.1	93 Np Neptunium (237)	94 Pu Plutonium (242)	95 Am Americium (243)	96 Cm Curium (247)	97 Bk Berkelium (245)	98 Cf Californium (251)	99 Es Einsteinium (254)	100 Fm Fermium (253)	101 Md Mendelevium (256)	102 No Nobelium (254)	103 Lr Lawrencium (257)
------------------------------	-----------------------------------	-----------------------------	--------------------------------	--------------------------------	--------------------------------	-----------------------------	--------------------------------	----------------------------------	----------------------------------	-------------------------------	-----------------------------------	--------------------------------	----------------------------------

As we can see, the Modern Periodic Table takes care of three limitations of Mendl ev's Periodic Table. The anomalous position of hydrogen can be discussed after we see what are the bases on which the position of an element in the Modern Periodic Table depends.

5.3.1 Position of Elements in the Modern Periodic Table

The Modern Periodic Table has 18 vertical columns known as 'groups' and 7 horizontal rows known as 'periods'. Let us see what decides the placing of an element in a certain group and period.

Activity 5.4

- Look at the group 1 of the Modern Periodic Table, and name the elements present in it.
- Write down the electronic configuration of the first three elements of group 1.
- What similarity do you find in their electronic configurations?
- How many valence electrons are present in these three elements?

You will find that all these elements contain the same number of valence electrons. Similarly, you will find that the elements present in any one group have the same number of valence electrons. For example, elements fluorine (F) and chlorine (Cl), belong to group 17, how many electrons do fluorine and chlorine have in their outermost shells? Hence, we can say that groups in the Periodic Table signify an identical outer-shell electronic configuration. On the other hand, the number of shells increases as we go down the group.

There is an anomaly when it comes to the position of hydrogen because it can be placed either in group 1 or group 17 in the first period. Can you say why?

Activity 5.5

- If you look at the Modern Periodic Table (5.6), you will find that the elements Li, Be, B, C, N, O, F, and Ne are present in the second period. Write down their electronic configurations.
- Do these elements also contain the same number of valence electrons?
- Do they contain the same number of shells?

You will find that these elements of second period do not have the same number of valence electrons, but they contain the same number of shells. You also observe that the number of valence shell electrons increases by one unit, as the atomic number increases by one unit on moving from left to right in a period.

Or we can say that atoms of different elements with the same number of occupied shells are placed in the same period. Na, Mg, Al, Si, P, S, Cl and Ar belong to the third period of the Modern Periodic Table, since the electrons in the atoms of these elements are filled in K, L and M shells. Write the electronic configuration of these elements and confirm the above statement. Each period marks a new electronic shell getting filled.

How many elements are there in the first, second, third and fourth periods?

We can explain the number of elements in these periods based on how electrons are filled into various shells. You will study the details of this in higher classes. Recall that the maximum number of electrons that can be accommodated in a shell depends on the formula $2n^2$ where 'n' is the number of the given shell from the nucleus.

For example,

K Shell - $2 \times (1)^2 = 2$, hence the first period has 2 elements.

L Shell - $2 \times (2)^2 = 8$, hence the second period has 8 elements.

The third, fourth, fifth, sixth and seventh periods have 8, 18, 18, 32 and 32 elements respectively.

The reason for this you will study in higher classes.

The position of an element in the Periodic Table tells us about its chemical reactivity. As you have learnt, the valence electrons determine the kind and number of bonds formed by an element. Can you now say why Mendeléeev's choice of formulae of compounds as the basis for deciding the position of an element in his Table was a good one? How would this lead to elements with similar chemical properties being placed in the same group?

5.3.2 Trends in the Modern Periodic Table

Valency : As you know, the valency of an element is determined by the number of valence electrons present in the outermost shell of its atom.

Activity 5.6

- How do you calculate the valency of an element from its electronic configuration?
- What is the valency of magnesium with atomic number 12 and sulphur with atomic number 16?
- Similarly find out the valencies of the first twenty elements.
- How does the valency vary in a period on going from left to right?
- How does the valency vary in going down a group?

Atomic size: The term atomic size refers to the radius of an atom. The atomic size may be visualised as the distance between the centre of the nucleus and the outermost shell of an isolated atom. The atomic radius of hydrogen atom is 37 pm (picometre, $1 \text{ pm} = 10^{-12}\text{m}$).

Let us study the variation of atomic size in a group and in a period.

Activity 5.7

- Atomic radii of the elements of the second period are given below:
Period II elements : B Be O N Li C
Atomic radius (pm) : 88 111 66 74 152 77
- Arrange them in decreasing order of their atomic radii.
- Are the elements now arranged in the pattern of a period in the Periodic Table?
- Which elements have the largest and the smallest atoms?
- How does the atomic radius change as you go from left to right in a period?

You will see that the atomic radius decreases in moving from left to right along a period. This is due to an increase in nuclear charge which tends to pull the electrons closer to the nucleus and reduces the size of the atom.

Activity 5.8

- Study the variation in the atomic radii of first group elements given below and arrange them in an increasing order.
Group 1 Elements : Na Li Rb Cs K
Atomic Radius (pm): 186 152 244 262 231
- Name the elements which have the smallest and the largest atoms.
- How does the atomic size vary as you go down a group?

You will see that the atomic size increases down the group. This is because new shells are being added as we go down the group. This increases the distance between the outermost electrons and the nucleus so that the atomic size increases in spite of the increase in nuclear charge.

Metallic and Non-metallic Properties

Activity 5.9

- Examine elements of the third period and classify them as metals and non-metals.
- On which side of the Periodic Table do you find the metals?
- On which side of the Periodic Table do you find the non-metals?

As we can see, the metals like Na and Mg are towards the left-hand side of the Periodic Table while the non-metals like sulphur and chlorine are found on the right-hand side. In the middle, we have silicon, which is classified as a semi-metal or metalloid because it exhibits some properties of both metals and non-metals.

In the Modern Periodic Table, a zig-zag line separates metals from non-metals. The borderline elements – boron, silicon, germanium, arsenic, antimony, tellurium and polonium – are intermediate in properties and are called metalloids or semi-metals.

As you have seen in Chapter 3, metals tend to lose electrons while forming bonds, that is, they are electropositive in nature.

Activity 5.10

- How do you think the tendency to lose electrons changes in a group?
- How will this tendency change in a period?

As the effective nuclear charge acting on the valence shell electrons increases across a period, the tendency to lose electrons will decrease. Down the group, the effective nuclear charge experienced by valence

electrons is decreasing because the outermost electrons are farther away from the nucleus. Therefore, these can be lost easily. Hence metallic character decreases across a period and increases down a group.

Non-metals, on the other hand, are electronegative. They tend to form bonds by gaining electrons. Let us learn about the variation of this property.

Activity 5.11

- How would the tendency to gain electrons change as you go from left to right across a period?
- How would the tendency to gain electrons change as you go down a group?

As the trends in the electronegativity show, non-metals are found on the right-hand side of the Periodic Table towards the top.

These trends also help us to predict the nature of oxides formed by the elements because it is known to you that the oxides of metals are basic and that of non-metals are acidic in general.

Q U E S T I O N S

1. How could the Modern Periodic Table remove various anomalies of MendeléeV's Periodic Table?
2. Name two elements you would expect to show chemical reactions similar to magnesium. What is the basis for your choice?
3. Name
 - (a) three elements that have a single electron in their outermost shells.
 - (b) two elements that have two electrons in their outermost shells.
 - (c) three elements with filled outermost shells.
4.
 - (a) Lithium, sodium, potassium are all metals that react with water to liberate hydrogen gas. Is there any similarity in the atoms of these elements?
 - (b) Helium is an unreactive gas and neon is a gas of extremely low reactivity. What, if anything, do their atoms have in common?
5. In the Modern Periodic Table, which are the metals among the first ten elements?
6. By considering their position in the Periodic Table, which one of the following elements would you expect to have maximum metallic characteristic?

Ga Ge As Se Be

What you have learnt

- Elements are classified on the basis of similarities in their properties.
- Döbereiner grouped the elements into triads and Newlands gave the Law of Octaves.
- Mendeléeiev arranged the elements in increasing order of their atomic masses and according to their chemical properties.
- Mendeléeiev even predicted the existence of some yet to be discovered elements on the basis of gaps in his Periodic Table.
- Anomalies in arrangement of elements based on increasing atomic mass could be removed when the elements were arranged in order of increasing atomic number, a fundamental property of the element discovered by Moseley.
- Elements in the Modern Periodic Table are arranged in 18 vertical columns called groups and 7 horizontal rows called periods.
- Elements thus arranged show periodicity of properties including atomic size, valency or combining capacity and metallic and non-metallic character.

EXERCISES

1. Which of the following statements is not a correct statement about the trends when going from left to right across the periods of periodic Table.
(a) The elements become less metallic in nature.
(b) The number of valence electrons increases.
(c) The atoms lose their electrons more easily.
(d) The oxides become more acidic.
2. Element X forms a chloride with the formula XCl_2 , which is a solid with a high melting point. X would most likely be in the same group of the Periodic Table as
(a) Na (b) Mg (c) Al (d) Si
3. Which element has
(a) two shells, both of which are completely filled with electrons?
(b) the electronic configuration 2, 8, 2?
(c) a total of three shells, with four electrons in its valence shell?
(d) a total of two shells, with three electrons in its valence shell?
(e) twice as many electrons in its second shell as in its first shell?
4. (a) What property do all elements in the same column of the Periodic Table as boron have in common?
(b) What property do all elements in the same column of the Periodic Table as fluorine have in common?
5. An atom has electronic configuration 2, 8, 7.
(a) What is the atomic number of this element?
(b) To which of the following elements would it be chemically similar? (Atomic numbers are given in parentheses.)
N(7) F(9) P(15) Ar(18)

6. The position of three elements A, B and C in the Periodic Table are shown below –

Group 16	Group 17
-	-
-	A
-	-
B	C

- State whether A is a metal or non-metal.
 - State whether C is more reactive or less reactive than A.
 - Will C be larger or smaller in size than B?
 - Which type of ion, cation or anion, will be formed by element A?
- Nitrogen (atomic number 7) and phosphorus (atomic number 15) belong to group 15 of the Periodic Table. Write the electronic configuration of these two elements. Which of these will be more electronegative? Why?
 - How does the electronic configuration of an atom relate to its position in the Modern Periodic Table?
 - In the Modern Periodic Table, calcium (atomic number 20) is surrounded by elements with atomic numbers 12, 19, 21 and 38. Which of these have physical and chemical properties resembling calcium?
 - Compare and contrast the arrangement of elements in Mendeléev's Periodic Table and the Modern Periodic Table.

Group Activity

- We have discussed the major attempts made for classifying elements. Find out (from the internet or library) about other attempts to classify elements.
- We have studied the long form of the Periodic Table. The Modern Periodic Law has been used to arrange elements in other ways too. Find out what are these.



CHAPTER 8

How do Organisms Reproduce?



Before we discuss the mechanisms by which organisms reproduce, let us ask a more basic question – why do organisms reproduce? After all, reproduction is not necessary to maintain the life of an individual organism, unlike the essential life processes such as nutrition, respiration, or excretion. On the other hand, if an individual organism is going to create more individuals, a lot of its energy will be spent in the process. So why should an individual organism waste energy on a process it does not need to stay alive? It would be interesting to discuss the possible answers in the classroom!

Whatever the answer to this question, it is obvious that we notice organisms because they reproduce. If there were to be only one, non-reproducing member of a particular kind, it is doubtful that we would have noticed its existence. It is the large numbers of organisms belonging to a single species that bring them to our notice. How do we know that two different individual organisms belong to the same species? Usually, we say this because they look similar to each other. Thus, reproducing organisms create new individuals that look very much like themselves.

8.1 DO ORGANISMS CREATE EXACT COPIES OF THEMSELVES?

Organisms look similar because their body designs are similar. If body designs are to be similar, the blueprints for these designs should be similar. Thus, reproduction at its most basic level will involve making copies of the blueprints of body design. In Class IX, we learnt that the chromosomes in the nucleus of a cell contain information for inheritance of features from parents to next generation in the form of DNA (Deoxyribo Nucleic Acid) molecules. The DNA in the cell nucleus is the information source for making proteins. If the information is changed, different proteins will be made. Different proteins will eventually lead to altered body designs.

Therefore, a basic event in reproduction is the creation of a DNA copy. Cells use chemical reactions to build copies of their DNA. This creates two copies of the DNA in a reproducing cell, and they will need to be separated from each other. However, keeping one copy of DNA in the original cell and simply pushing the other one out would not work,

because the copy pushed out would not have any organised cellular structure for maintaining life processes. Therefore, DNA copying is accompanied by the creation of an additional cellular apparatus, and then the DNA copies separate, each with its own cellular apparatus. Effectively, a cell divides to give rise to two cells.

These two cells are of course similar, but are they likely to be absolutely identical? The answer to this question will depend on how accurately the copying reactions involved occur. No bio-chemical reaction is absolutely reliable. Therefore, it is only to be expected that the process of copying the DNA will have some variations each time. As a result, the DNA copies generated will be similar, but may not be identical to the original. Some of these variations might be so drastic that the new DNA copy cannot work with the cellular apparatus it inherits. Such a newborn cell will simply die. On the other hand, there could still be many other variations in the DNA copies that would not lead to such a drastic outcome. Thus, the surviving cells are similar to, but subtly different from each other. This inbuilt tendency for variation during reproduction is the basis for evolution, as we will discuss in the next chapter.

8.1.1 The Importance of Variation

Populations of organisms fill well-defined places, or niches, in the ecosystem, using their ability to reproduce. The consistency of DNA copying during reproduction is important for the maintenance of body design features that allow the organism to use that particular niche. Reproduction is therefore linked to the stability of populations of species.

However, niches can change because of reasons beyond the control of the organisms. Temperatures on earth can go up or down, water levels can vary, or there could be meteorite hits, to think of a few examples. If a population of reproducing organisms were suited to a particular niche and if the niche were drastically altered, the population could be wiped out. However, if some variations were to be present in a few individuals in these populations, there would be some chance for them to survive. Thus, if there were a population of bacteria living in temperate waters, and if the water temperature were to be increased by global warming, most of these bacteria would die, but the few variants resistant to heat would survive and grow further. Variation is thus useful for the survival of species over time.

Q U E S T I O N S

1. What is the importance of DNA copying in reproduction?
2. Why is variation beneficial to the species but not necessarily for the individual?



8.2 MODES OF REPRODUCTION USED BY SINGLE ORGANISMS

Activity 8.1

- Dissolve about 10 gm of sugar in 100 mL of water.
- Take 20 mL of this solution in a test tube and add a pinch of yeast granules to it.
- Put a cotton plug on the mouth of the test tube and keep it in a warm place.
- After 1 or 2 hours, put a small drop of yeast culture from the test tube on a slide and cover it with a coverslip.
- Observe the slide under a microscope.

Activity 8.2

- Wet a slice of bread, and keep it in a cool, moist and dark place.
- Observe the surface of the slice with a magnifying glass.
- Record your observations for a week.

Compare and contrast the ways in which yeast grows in the first case, and how mould grows in the second.

Having discussed the context in which reproductive processes work, let us now examine how different organisms actually reproduce. The modes by which various organisms reproduce depend on the body design of the organisms.

8.2.1 Fission

For unicellular organisms, cell division, or fission, leads to the creation of new individuals. Many different patterns of fission have been observed. Many bacteria and protozoa simply split into two equal halves during cell division. In organisms such as *Amoeba*, the splitting of the two cells during division can take place in any plane.

Activity 8.3

- Observe a permanent slide of *Amoeba* under a microscope.
- Similarly observe another permanent slide of *Amoeba* showing binary fission.
- Now, compare the observations of both the slides.

However, some unicellular organisms show somewhat more organisation of their bodies, such as is seen in *Leishmania* (which cause *kala-azar*), which have a whip-like structure at one end of the cell. In such organisms, binary fission occurs in a definite orientation in relation to

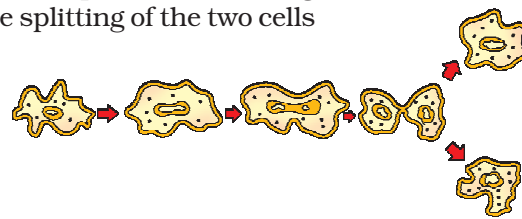

Figure 8.1(a) Binary fission in *Amoeba*

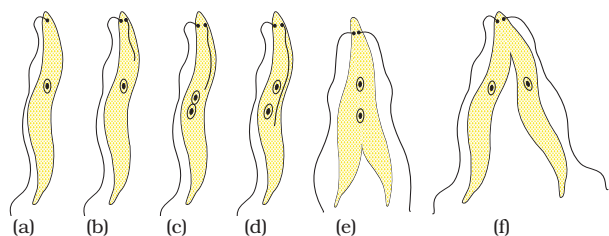

Figure 8.1(b) Binary fission in *Leishmania*

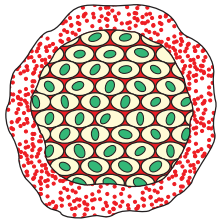

Figure 8.2
Multiple fission in
Plasmodium

these structures. Other single-celled organisms, such as the malarial parasite, *Plasmodium*, divide into many daughter cells simultaneously by multiple fission.

Yeast, on the other hand, can put out small buds that separate and grow further, as we saw in Activity 8.1.

8.2.2 Fragmentation

Activity 8.4

- Collect water from a lake or pond that appears dark green and contains filamentous structures.
- Put one or two filaments on a slide.
- Put a drop of glycerine on these filaments and cover it with a coverslip.
- Observe the slide under a microscope.
- Can you identify different tissues in the *Spirogyra* filaments?

In multi-cellular organisms with relatively simple body organisation, simple reproductive methods can still work. *Spirogyra*, for example, simply breaks up into smaller pieces upon maturation. These pieces or fragments grow into new individuals. Can we work out the reason for this, based on what we saw in Activity 8.4?

This is not true for all multi-cellular organisms. They cannot simply divide cell-by-cell. The reason is that many multi-cellular organisms, as we have seen, are not simply a random collection of cells. Specialised cells are organised as tissues, and tissues are organised into organs, which then have to be placed at definite positions in the body. In such a carefully organised situation, cell-by-cell division would be impractical. Multi-cellular organisms, therefore, need to use more complex ways of reproduction.

A basic strategy used in multi-cellular organisms is that different cell types perform different specialised functions. Following this general pattern, reproduction in such organisms is also the function of a specific cell type. How is reproduction to be achieved from a single cell type, if the organism itself consists of many cell types? The answer is that there must be a single cell type in the organism that is capable of growing, proliferating and making other cell types under the right circumstances.

8.2.3 Regeneration

Many fully differentiated organisms have the ability to give rise to new individual organisms from their body parts. That is, if the individual is somehow cut or broken up into many pieces, many of these pieces grow into separate individuals. For example, simple animals like *Hydra* and *Planaria* can be cut into any number of pieces and each piece grows into a complete organism. This is known as regeneration (see Fig. 8.3). Regeneration is carried out by specialised cells. These cells proliferate and make large numbers of cells. From this mass of cells, different cells undergo changes to become various cell types and tissues. These changes

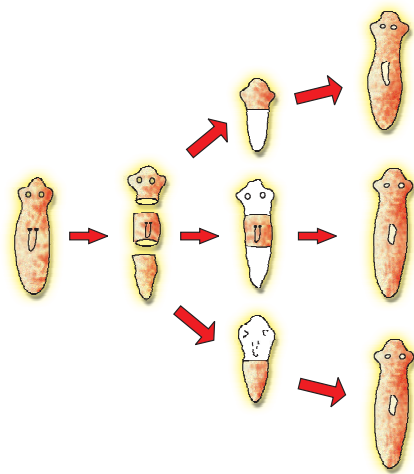

Figure 8.3 Regeneration in *Planaria*

take place in an organised sequence referred to as development. However, regeneration is not the same as reproduction, since most organisms would not normally depend on being cut up to be able to reproduce.

8.2.4 Budding

Organisms such as *Hydra* use regenerative cells for reproduction in the process of budding. In *Hydra*, a bud develops as an outgrowth due to repeated cell division at one

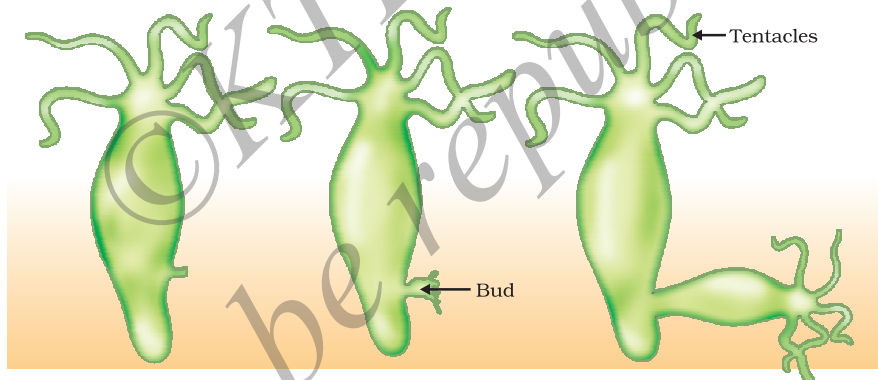

Figure 8.4 Budding in *Hydra*

8.2.5 Vegetative Propagation

These buds develop into tiny individuals and when fully mature, detach from the parent body and become new independent individuals.

There are many plants in which parts like the root, stem and leaves develop into new plants under appropriate conditions. Unlike in most animals, plants can indeed use such a mode for reproduction. This property of vegetative propagation is used in methods such as layering or grafting to grow many plants like sugarcane, roses, or grapes for agricultural purposes. Plants raised by vegetative propagation can bear flowers and fruits earlier than those produced from seeds. Such methods also make possible the propagation of plants such as banana, orange, rose and jasmine that have lost the capacity to produce seeds. Another advantage of vegetative propagation is that all plants produced are genetically similar enough to the parent plant to have all its characteristics.

How do Organisms Reproduce?

Activity 8.5

- Take a potato and observe its surface. Can notches be seen?
- Cut the potato into small pieces such that some pieces contain a notch or bud and some do not.
- Spread some cotton on a tray and wet it. Place the potato pieces on this cotton. Note where the pieces with the buds are placed.
- Observe changes taking place in these potato pieces over the next few days. Make sure that the cotton is kept moistened.
- Which are the potato pieces that give rise to fresh green shoots and roots?

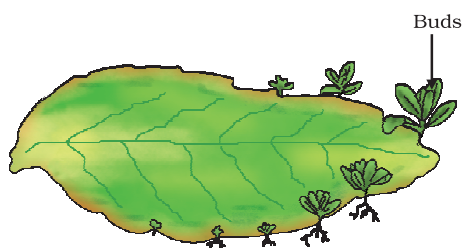

Figure 8.5
Leaf of *Bryophyllum*
with buds

Similarly buds produced in the notches along the leaf margin of *Bryophyllum* fall on the soil and develop into new plants (Fig. 8.5).

Activity 8.6

- Select a money-plant.
- Cut some pieces such that they contain at least one leaf.
- Cut out some other portions between two leaves.
- Dip one end of all the pieces in water and observe over the next few days.
- Which ones grow and give rise to fresh leaves?
- What can you conclude from your observations?

More to Know?

Tissue culture

In tissue culture, new plants are grown by removing tissue or separating cells from the growing tip of a plant. The cells are then placed in an artificial medium where they divide rapidly to form a small group of cells or callus. The callus is transferred to another medium containing hormones for growth and differentiation. The plantlets are then placed in the soil so that they can grow into mature plants. Using tissue culture, many plants can be grown from one parent in disease-free conditions. This technique is commonly used for ornamental plants.

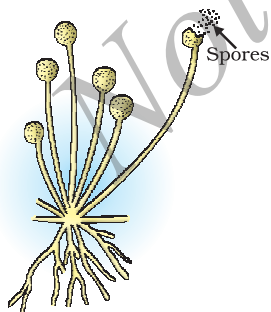

Figure 8.6
Spore formation in *Rhizopus*

8.2.6 Spore Formation

Even in many simple multi-cellular organisms, specific reproductive parts can be identified. The thread-like structures that developed on the bread in Activity 8.2 above are the hyphae of the bread mould (*Rhizopus*). They are not reproductive parts. On the other hand, the tiny blob-on-a-stick structures are involved in reproduction. The blobs are sporangia, which contain cells, or spores, that can eventually develop into new *Rhizopus* individuals (Fig. 8.6). The spores are covered by thick walls that protect them until they come into contact with another moist surface and can begin to grow.

All the modes of reproduction that we have discussed so far allow new generations to be created from a single individual. This is known as asexual reproduction.

Q U E S T I O N S

1. How does binary fission differ from multiple fission?
2. How will an organism be benefited if it reproduces through spores?
3. Can you think of reasons why more complex organisms cannot give rise to new individuals through regeneration?
4. Why is vegetative propagation practised for growing some types of plants?
5. Why is DNA copying an essential part of the process of reproduction?

8.3 SEXUAL REPRODUCTION

We are also familiar with modes of reproduction that depend on the involvement of two individuals before a new generation can be created. Bulls alone cannot produce new calves, nor can hens alone produce new chicks. In such cases, both sexes, males and females, are needed to produce new generations. What is the significance of this sexual mode of reproduction? Are there any limitations of the asexual mode of reproduction, which we have been discussing above?

8.3.1 Why the Sexual Mode of Reproduction?

The creation of two new cells from one involves copying of the DNA as well as of the cellular apparatus. The DNA copying mechanism, as we have noted, cannot be absolutely accurate, and the resultant errors are a source of variations in populations of organisms. Every individual organism cannot be protected by variations, but in a population, variations are useful for ensuring the survival of the species. It would therefore make sense if organisms came up with reproductive modes that allowed more and more variation to be generated.

While DNA-copying mechanisms are not absolutely accurate, they are precise enough to make the generation of variation a fairly slow process. If the DNA copying mechanisms were to be less accurate, many of the resultant DNA copies would not be able to work with the cellular apparatus, and would die. So how can the process of making variants be speeded up? Each new variation is made in a DNA copy that already has variations accumulated from previous generations. Thus, two different individuals in a population would have quite different patterns of accumulated variations. Since all of these variations are in living individuals, it is assured that they do not have any really bad effects. Combining variations from two or more individuals would thus create new combinations of variants. Each combination would be novel, since it would involve two different individuals. The sexual mode of

reproduction incorporates such a process of combining DNA from two different individuals during reproduction.

But this creates a major difficulty. If each new generation is to be the combination of the DNA copies from two pre-existing individuals, then each new generation will end up having twice the amount of DNA that the previous generation had. This is likely to mess up the control of the cellular apparatus by the DNA. How many ways can we think of for solving this difficulty?

We have seen earlier that as organisms become more complex, the specialisation of tissue increases. One solution that many multi-cellular organisms have found for the problem mentioned above is to have specialised lineages of cells in specialised organs in which only half the number of chromosomes and half the amount of DNA as compared to the non-reproductive body cells. This is achieved by a process of cell division called meiosis. Thus, when these germ-cells from two individuals combine during sexual reproduction to form a new individual, it results in re-establishment of the number of chromosomes and the DNA content in the new generation.

If the zygote is to grow and develop into an organism which has highly specialised tissues and organs, then it has to have sufficient stores of energy for doing this. In very simple organisms, it is seen that the two germ-cells are not very different from one another, or may even be similar. But as the body designs become more complex, the germ-cells also specialise. One germ-cell is large and contains the food-stores while the other is smaller and likely to be motile. Conventionally, the motile germ-cell is called the male gamete and the germ-cell containing the stored food is called the female gamete. We shall see in the next few sections how the need to create these two different types of gametes give rise to differences in the male and female reproductive organs and, in some cases, differences in the bodies of the male and female organisms.

8.3.2 Sexual Reproduction in Flowering Plants

The reproductive parts of angiosperms are located in the flower. You have already studied the different parts of a flower – sepals, petals, stamens and pistil. Stamens and pistil are the reproductive parts of a flower which contain the germ-cells. What possible functions could the petals and sepals serve?

The flower may be unisexual (papaya, watermelon) when it contains either stamens or pistil or bisexual (*Hibiscus*, mustard) when it contains both stamens and pistil. Stamen is the male reproductive part and it produces pollen grains that are yellowish in colour. You must have seen this yellowish powder that often sticks to our hands if we touch the stamen of a flower. Pistil is present in the centre of a flower and is the female reproductive part. It is made of three parts.

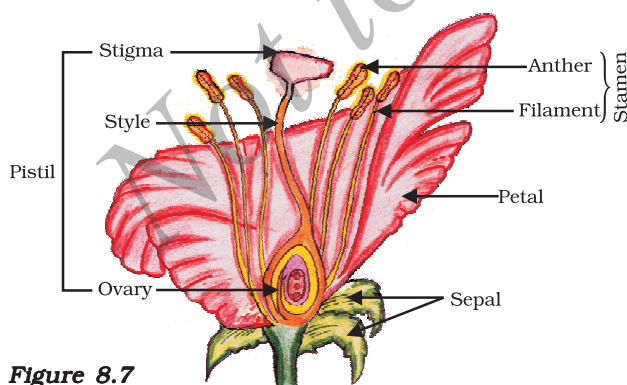

Figure 8.7
Longitudinal section of
flower

The swollen bottom part is the ovary, middle elongated part is the style and the terminal part which may be sticky is the stigma. The ovary contains ovules and each ovule has an egg cell. The male germ-cell produced by pollen grain fuses with the female gamete present in the ovule. This fusion of the germ-cells or fertilisation gives us the zygote which is capable of growing into a new plant.

Thus the pollen needs to be transferred from the stamen to the stigma. If this transfer of pollen occurs in the same flower, it is referred to as self-pollination. On the other hand, if the pollen is transferred from one flower to another, it is known as cross-pollination. This transfer of pollen from one flower to another is achieved by agents like wind, water or animals.

After the pollen lands on a suitable stigma, it has to reach the female germ-cells which are in the ovary. For this, a tube grows out of the pollen grain and travels through the style to reach the ovary.

After fertilisation, the zygote divides several times to form an embryo within the ovule. The ovule develops a tough coat and is gradually converted into a seed. The ovary grows rapidly and ripens to form a fruit. Meanwhile, the petals, sepals, stamens, style and stigma may shrivel and fall off. Have you ever observed any flower part still persisting in the fruit? Try and work out the advantages of seed-formation for the plant. The seed contains the future plant or embryo which develops into a seedling under appropriate conditions. This process is known as germination.

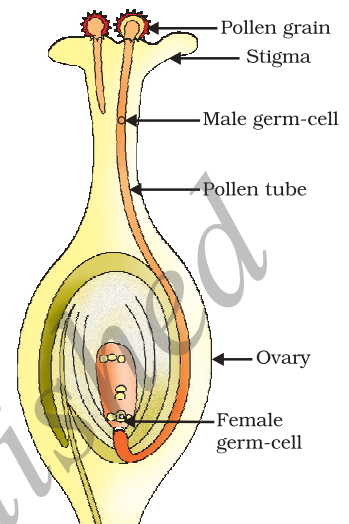

Figure 8.8
Germination of pollen on stigma

Activity 8.7

- Soak a few seeds of Bengal gram (*chana*) and keep them overnight.
- Drain the excess water and cover the seeds with a wet cloth and leave them for a day. Make sure that the seeds do not become dry.
- Cut open the seeds carefully and observe the different parts.
- Compare your observations with the Fig. 8.9 and see if you can identify all the parts.

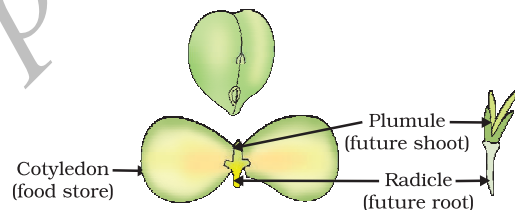

Figure 8.9
Germination

8.3.3 Reproduction in Human Beings

So far, we have been discussing the variety of modes that different species use for reproduction. Let us now look at the species that we are most interested in, namely, humans. Humans use a sexual mode of reproduction. How does this process work?

Let us begin at an apparently unrelated point. All of us know that our bodies change as we become older. You have learnt changes that take place in your body earlier in Class VIII also. We notice that our height has increased continuously from early age till now. We acquire teeth, we even lose the old, so-called milk teeth and acquire new ones.

How do Organisms Reproduce?

All of these are changes that can be grouped under the general process of growth, in which the body becomes larger. But in early teenage years, a whole new set of changes occurs that cannot be explained simply as body enlargement. Instead, the appearance of the body changes. Proportions change, new features appear, and so do new sensations.

Some of these changes are common to both boys and girls. We begin to notice thick hair growing in new parts of the body such as armpits and the genital area between the thighs, which can also become darker in colour. Thinner hair can also appear on legs and arms, as well as on the face. The skin frequently becomes oily and we might begin to develop pimples. We begin to be conscious and aware of both our own bodies and those of others in new ways.

On the other hand, there are also changes taking place that are different between boys and girls. In girls, breast size begins to increase, with darkening of the skin of the nipples at the tips of the breasts. Also, girls begin to menstruate at around this time. Boys begin to have new thick hair growth on the face and their voices begin to crack. Further, the penis occasionally begins to become enlarged and erect, either in daydreams or at night.

All of these changes take place slowly, over a period of months and years. They do not happen all at the same time in one person, nor do they happen at an exact age. In some people, they happen early and quickly, while in others, they can happen slowly. Also, each change does not become complete quickly either. So, for example, thick hair on the face in boys appears as a few scattered hairs first, and only slowly does the growth begin to become uniform. Even so, all these changes show differences between people. Just as we have differently shaped noses or fingers, so also we have different patterns of hair growth, or size and shape of breast or penis. All of these changes are aspects of the sexual maturation of the body.

Why does the body show sexual maturation at this age? We have talked about the need for specialised cell types in multi-cellular bodies to carry out specialised functions. The creation of germ-cells to participate in sexual reproduction is another specialised function, and we have seen that plants develop special cell and tissue types to create them. Human beings also develop special tissues for this purpose. However, while the body of the individual organism is growing to its adult size, the resources of the body are mainly directed at achieving this growth. While that is happening, the maturation of the reproductive tissue is not likely to be a major priority. Thus, as the rate of general body growth begins to slow down, reproductive tissues begin to mature. This period during adolescence is called puberty.

So how do all the changes that we have talked about link to the reproductive process? We must remember that the sexual mode of reproduction means that germ-cells from two individuals have to join together. This can happen by the external release of germ-cells from the bodies of individuals, as happens in flowering plants. Or it can happen by two individuals joining their bodies together for internal transfer of germ-cells for fusion, as happens in many animals. If animals are to

participate in this process of mating, their state of sexual maturity must be identifiable by other individuals. Many changes during puberty, such as new hair-growth patterns, are signals that sexual maturation is taking place.

On the other hand, the actual transfer of germ-cells between two people needs special organs for the sexual act, such as the penis when it is capable of becoming erect. In mammals such as humans, the baby is carried in the mother's body for a long period, and will be breast-fed later. The female reproductive organs and breasts will need to mature to accommodate these possibilities. Let us look at the systems involved in the process of sexual reproduction.

8.3.3 (a) Male Reproductive System

The male reproductive system (Fig. 8.10) consists of portions which produce the germ-cells and other portions that deliver the germ-cells to the site of fertilisation.

The formation of germ-cells or sperms takes place in the testes. These are located outside the abdominal cavity in scrotum because sperm formation requires a lower temperature than the normal body temperature. We have discussed the role of the testes in the secretion of the hormone, testosterone, in the previous chapter. In addition to regulating the formation of sperms, testosterone brings about changes in appearance seen in boys at the time of puberty.

The sperms formed are delivered through the vas deferens which unites with a tube coming from the urinary bladder. The urethra thus forms a common passage for both the sperms and urine. Along the path of the vas deferens, glands like the prostate and the seminal vesicles add their secretions so that the sperms are now in a fluid which makes their transport easier and this fluid also provides nutrition. The sperms are tiny bodies that consist of mainly genetic material and a long tail that helps them to move towards the female germ-cell.

8.3.3 (b) Female Reproductive System

The female germ-cells or eggs are made in the ovaries. They are also responsible for the production of some hormones. Look at Fig. 8.11 and identify the various organs in the female reproductive system.

How do Organisms Reproduce?

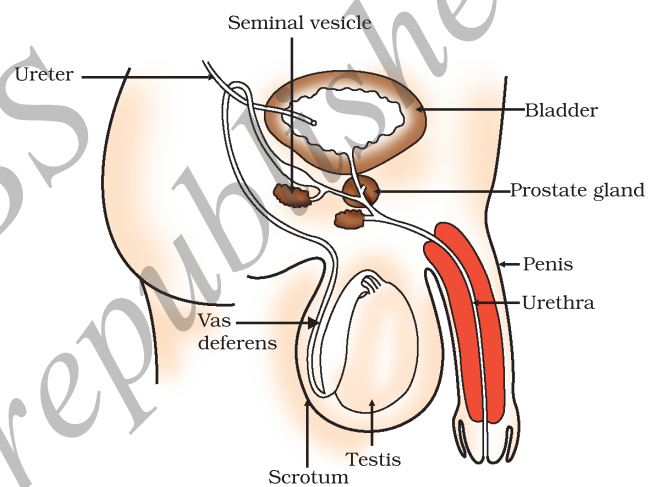

Figure 8.10 Human–male reproductive system

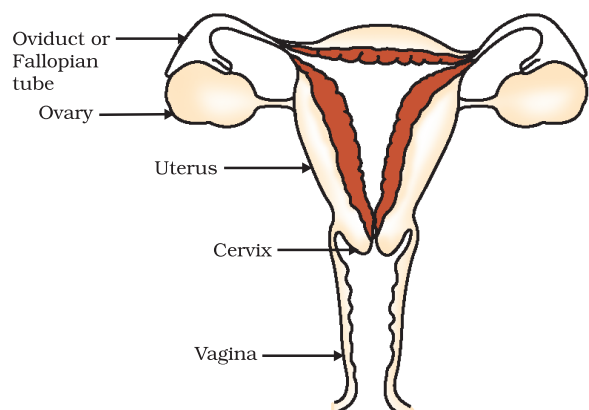

Figure 8.11 Human–female reproductive system

When a girl is born, the ovaries already contain thousands of immature eggs. On reaching puberty, some of these start maturing. One egg is produced every month by one of the ovaries. The egg is carried from the ovary to the womb through a thin oviduct or fallopian tube. The two oviducts unite into an elastic bag-like structure known as the uterus. The uterus opens into the vagina through the cervix.

The sperms enter through the vaginal passage during sexual intercourse. They travel upwards and reach the oviduct where they may encounter the egg. The fertilised egg (zygote) starts dividing and form a ball of cells or embryo. The embryo is implanted in the lining of the uterus where they continue to grow and develop organs to become foetus. We have seen in earlier sections that the mother's body is designed to undertake the development of the child. Hence the uterus prepares itself every month to receive and nurture the growing embryo. The lining thickens and is richly supplied with blood to nourish the growing embryo.

The embryo gets nutrition from the mother's blood with the help of a special tissue called placenta. This is a disc which is embedded in the uterine wall. It contains villi on the embryo's side of the tissue. On the mother's side are blood spaces, which surround the villi. This provides a large surface area for glucose and oxygen to pass from the mother to the embryo. The developing embryo will also generate waste substances which can be removed by transferring them into the mother's blood through the placenta. The development of the child inside the mother's body takes approximately nine months. The child is born as a result of rhythmic contractions of the muscles in the uterus.

8.3.3 (c) What happens when the Egg is not Fertilised?

If the egg is not fertilised, it lives for about one day. Since the ovary releases one egg every month, the uterus also prepares itself every month to receive a fertilised egg. Thus its lining becomes thick and spongy. This would be required for nourishing the embryo if fertilisation had taken place. Now, however, this lining is not needed any longer. So, the lining slowly breaks and comes out through the vagina as blood and mucous. This cycle takes place roughly every month and is known as menstruation. It usually lasts for about two to eight days.

8.3.3 (d) Reproductive Health

As we have seen, the process of sexual maturation is gradual, and takes place while general body growth is still going on. Therefore, some degree of sexual maturation does not necessarily mean that the body or the mind is ready for sexual acts or for having and bringing up children. How do we decide if the body or the mind is ready for this major responsibility? All of us are under many different kinds of pressures about these issues. There can be pressure from our friends for participating in many activities, whether we really want to or not. There can be pressure from families to get married and start having children. There can be pressure from government agencies to avoid having children. In this situation, making choices can become very difficult.

We must also consider the possible health consequences of having sex. We have discussed in Class IX that diseases can be transmitted from person to person in a variety of ways. Since the sexual act is a very intimate connection of bodies, it is not surprising that many diseases can be sexually transmitted. These include bacterial infections such as gonorrhoea and syphilis, and viral infections such as warts and HIV-AIDS. Is it possible to prevent the transmission of such diseases during the sexual act? Using a covering, called a condom, for the penis during sex helps to prevent transmission of many of these infections to some extent.

The sexual act always has the potential to lead to pregnancy. Pregnancy will make major demands on the body and the mind of the woman, and if she is not ready for it, her health will be adversely affected. Therefore, many ways have been devised to avoid pregnancy. These contraceptive methods fall in a number of categories. One category is the creation of a mechanical barrier so that sperm does not reach the egg. Condoms on the penis or similar coverings worn in the vagina can serve this purpose. Another category of contraceptives acts by changing the hormonal balance of the body so that eggs are not released and fertilisation cannot occur. These drugs commonly need to be taken orally as pills. However, since they change hormonal balances, they can cause side-effects too. Other contraceptive devices such as the loop or the copper-T are placed in the uterus to prevent pregnancy. Again, they can cause side effects due to irritation of the uterus. If the vas deferens in the male is blocked, sperm transfer will be prevented. If the fallopian tube in the female is blocked, the egg will not be able to reach the uterus. In both cases fertilisation will not take place. Surgical methods can be used to create such blocks. While surgical methods are safe in the long run, surgery itself can cause infections and other problems if not performed properly. Surgery can also be used for removal of unwanted pregnancies. These may be misused by people who do not want a particular child, as happens in illegal sex-selective abortion of female foetuses. For a healthy society, the female-male sex ratio must be maintained. Because of reckless female foeticides, child sex ratio is declining at an alarming rate in some sections of our society, although prenatal sex determination has been prohibited by law.

We have noted earlier that reproduction is the process by which organisms increase their populations. The rates of birth and death in a given population will determine its size. The size of the human population is a cause for concern for many people. This is because an expanding population makes it harder to improve everybody's standard of living. However, if inequality in society is the main reason for poor standards of living for many people, the size of the population is relatively unimportant. If we look around us, what can we identify as the most important reason(s) for poor living standards?

How do Organisms Reproduce?

Q U E S T I O N S

1. How is the process of pollination different from fertilisation?
2. What is the role of the seminal vesicles and the prostate gland?
3. What are the changes seen in girls at the time of puberty?
4. How does the embryo get nourishment inside the mother's body?
5. If a woman is using a copper-T, will it help in protecting her from sexually transmitted diseases?

What you have learnt

- Reproduction, unlike other life processes, is not essential to maintain the life of an individual organism.
- Reproduction involves creation of a DNA copy and additional cellular apparatus by the cell involved in the process.
- Various organisms use different modes of reproduction depending on their body design.
- In fission, many bacteria and protozoa simply divide into two or more daughter cells.
- Organisms such as hydra can regenerate if they are broken into pieces. They can also give out buds which mature into new individuals.
- Roots, stems and leaves of some plants develop into new plants through vegetative propagation.
- These are examples of asexual reproduction where new generations are created from a single individual.
- Sexual reproduction involves two individuals for the creation of a new individual.
- DNA copying mechanisms creates variations which are useful for ensuring the survival of the species. Modes of sexual reproduction allow for greater variation to be generated.
- Reproduction in flowering plants involves transfer of pollen grains from the anther to the stigma which is referred to as pollination. This is followed by fertilisation.
- Changes in the body at puberty, such as increase in breast size in girls and new facial hair growth in boys, are signs of sexual maturation.
- The male reproductive system in human beings consists of testes which produce sperms, vas deferens, seminal vesicles, prostate gland, urethra and penis.
- The female reproductive system in human beings consists of ovaries, fallopian tubes, uterus and vagina.
- Sexual reproduction in human beings involves the introduction of sperm in the vagina of the female. Fertilisation occurs in the fallopian tube.
- Contraception to avoid pregnancy can be achieved by the use of condoms, oral pills, copper-T and other methods.

E X E R C I S E S

1. Asexual reproduction takes place through budding in
 - (a) *amoeba*.
 - (b) yeast.
 - (c) *plasmodium*.
 - (d) *leishmania*.
2. Which of the following is not a part of the female reproductive system in human beings?
 - (a) Ovary
 - (b) Uterus
 - (c) Vas deferens
 - (d) Fallopian tube
3. The anther contains
 - (a) sepals.
 - (b) ovules.
 - (c) pistil.
 - (d) pollen grains.
4. What are the advantages of sexual reproduction over asexual reproduction?
5. What are the functions performed by the testis in human beings?
6. Why does menstruation occur?
7. Draw a labelled diagram of the longitudinal section of a flower.
8. What are the different methods of contraception?
9. How are the modes for reproduction different in unicellular and multicellular organisms?
10. How does reproduction help in providing stability to populations of species?
11. What could be the reasons for adopting contraceptive methods?

CHAPTER 9

Heredity and Evolution



We have seen that reproductive processes give rise to new individuals that are similar, but subtly different. We have discussed how some amount of variation is produced even during asexual reproduction. And the number of successful variations are maximised by the process of sexual reproduction. If we observe a field of sugarcane we find very little variations among the individual plants. But in a number of animals including human beings, which reproduce sexually, quite distinct variations are visible among different individuals. In this chapter, we shall be studying the mechanism by which variations are created and inherited. The long-term consequences of the accumulation of variations are also an interesting point to be considered. We shall be studying this under evolution.

9.1 ACCUMULATION OF VARIATION DURING REPRODUCTION

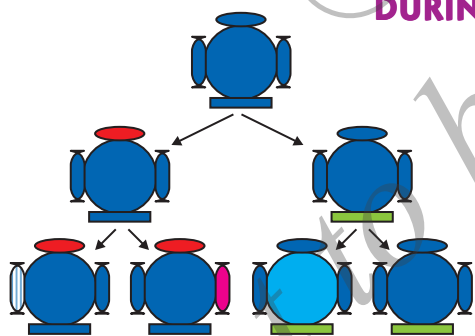

Figure 9.1
Creation of diversity over succeeding generations. The original organism at the top will give rise to, say, two individuals, similar in body design, but with subtle differences. Each of them, in turn, will give rise to two individuals in the next generation. Each of the four individuals in the bottom row will be different from each other. While some of these differences will be unique, others will be inherited from their respective parents, who were different from each other.

Inheritance from the previous generation provides both a common basic body design, and subtle changes in it, for the next generation. Now think about what would happen when this new generation, in its turn, reproduces. The second generation will have differences that they inherit from the first generation, as well as newly created differences (Fig. 9.1).

Figure 9.1 would represent the situation if a single individual reproduces, as happens in asexual reproduction. If one bacterium divides, and then the resultant two bacteria divide again, the four individual bacteria generated would be very similar. There would be only very minor differences between them, generated due to small inaccuracies in DNA copying. However, if sexual reproduction is involved, even greater diversity will be generated, as we will see when we discuss the rules of inheritance.

Do all these variations in a species have equal chances of surviving in the environment in which they find themselves? Obviously not. Depending on the nature of variations, different individuals would have

different kinds of advantages. Bacteria that can withstand heat will survive better in a heat wave, as we have discussed earlier. Selection of variants by environmental factors forms the basis for evolutionary processes, as we will discuss in later sections.

Q U E S T I O N S

1. If a trait A exists in 10% of a population of an asexually reproducing species and a trait B exists in 60% of the same population, which trait is likely to have arisen earlier?
2. How does the creation of variations in a species promote survival?

9.2 HEREDITY

The most obvious outcome of the reproductive process still remains the generation of individuals of similar design. The rules of heredity determine the process by which traits and characteristics are reliably inherited. Let us take a closer look at these rules.

9.2.1 Inherited Traits

What exactly do we mean by similarities and differences? We know that a child bears all the basic features of a human being. However, it does not look exactly like its parents, and human populations show a great deal of variation.

Activity 9.1

- Observe the ears of all the students in the class. Prepare a list of students having free or attached earlobes and calculate the percentage of students having each (Fig. 9.2). Find out about the earlobes of the parents of each student in the class. Correlate the earlobe type of each student with that of their parents. Based on this evidence, suggest a possible rule for the inheritance of earlobe types.



(a)

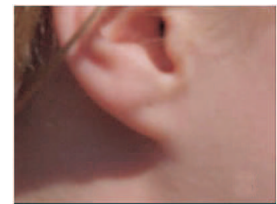

(b)

9.2.2 Rules for the Inheritance of Traits – Mendel's Contributions

The rules for inheritance of such traits in human beings are related to the fact that both the father and the mother contribute practically equal amounts of genetic material to the child. This means that each trait can be influenced by both paternal and maternal DNA. Thus, for each trait there will be two versions in each child. What will, then, the trait seen in the child be? Mendel (see box) worked out the main rules of such inheritance, and it is interesting to look at some of his experiments from more than a century ago.

Figure 9.2
(a) Free and (b) attached earlobes. The lowest part of the ear, called the earlobe, is closely attached to the side of the head in some of us, and not in others. Free and attached earlobes are two variants found in human populations.

Gregor Johann Mendel (1822–1884)



Mendel was educated in a monastery and went on to study science and mathematics at the University of Vienna. Failure in the examinations for a teaching certificate did not suppress his zeal for scientific quest. He went back to his monastery and started growing peas. Many others had studied the inheritance of traits in peas and other organisms earlier, but Mendel blended his knowledge of science and mathematics and was the first one to keep count of individuals exhibiting a particular trait in each generation. This helped him to arrive at the laws of inheritance.

Mendel used a number of contrasting visible characters of garden peas – round/wrinkled seeds, tall/short plants, white/violet flowers and so on. He took pea plants with different characteristics – a tall plant and a short plant, produced progeny by crossing them, and calculated the percentages of tall or short progeny.

In the first place, there were no halfway characteristics in this first-generation, or F1 progeny – no ‘medium-height’ plants. All plants were tall. This meant that only one of the parental traits was seen, not some mixture of the two. So the next question was, were the tall plants in the F1 generation exactly the same as the tall plants of the parent generation?

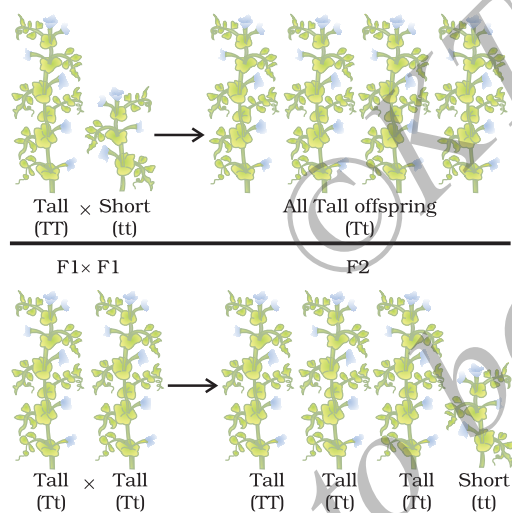

Mendelian experiments test this by getting both the parental plants and these F1 tall plants to reproduce by self-pollination. The progeny of the parental plants are, of course, all tall. However, the second-generation, or F2, progeny of the F1 tall plants are not all tall. Instead, one quarter of them are short. This indicates that both the tallness and shortness traits were inherited in the F1 plants, but only the tallness trait was expressed. This led Mendel to propose that two copies of factor (now called genes) controlling traits are present in sexually reproducing organism. These two may be identical, or may be different, depending on the parentage. A pattern of inheritance can be worked out with this assumption, as shown in Fig. 9.3.

Figure 9.3
Inheritance of traits
over two generations

Activity 9.2

- In Fig. 9.3, what experiment would we do to confirm that the F2 generation did in fact have a 1:2:1 ratio of TT, Tt and tt trait combinations?

In this explanation, both TT and Tt are tall plants, while only tt is a short plant. In other words, a single copy of ‘T’ is enough to make the plant tall, while both copies have to be ‘t’ for the plant to be short. Traits like ‘T’ are called dominant traits, while those that behave like ‘t’ are called recessive traits. Work out which trait would be considered dominant and which one recessive in Fig. 9.4.

What happens when pea plants showing two different characteristics, rather than just one, are bred with each other? What do the progeny of a tall plant with round seeds and a short plant with wrinkled-seeds look like? They are all tall and have round seeds. Tallness and round seeds are thus dominant traits. But what happens when these F1 progeny are used to generate F2 progeny by self-pollination? A Mendelian experiment will find that some F2 progeny are tall plants with round seeds, and some were short plants with wrinkled seeds. However, there would also be some F2 progeny that showed new combinations. Some of them would be tall, but have wrinkled seeds, while others would be short, but have round seeds. You can see as to how new combinations of traits are formed in F2 offspring when factors controlling for seed shape and seed colour recombine to form zygote leading to form F2 offspring (Fig. 9.5). Thus, the tall/short trait and the round seed/wrinkled seed trait are independently inherited.

9.2.3 How do these Traits get Expressed?

How does the mechanism of heredity work? Cellular DNA is the information source for making proteins in the cell. A section of DNA that provides information for one protein is called the gene for that protein. How do proteins control the characteristics that we are discussing here? Let us take the example of tallness as a characteristic. We know that plants have hormones that can trigger growth. Plant height can thus depend on the amount of a particular plant hormone. The amount of the plant hormone made will depend on the efficiency of the process for making it. Consider now an enzyme that is important for this process. If this enzyme works efficiently, a lot of hormone will be made, and the plant will be tall. If the gene for that enzyme has an alteration that makes the enzyme less efficient, the amount of hormone will be less, and the plant will be short. Thus, genes control characteristics, or traits.

If the interpretations of Mendelian experiments we have been discussing are correct, then both parents must be contributing equally to the DNA of the progeny during sexual reproduction. We have discussed this issue in the previous Chapter. If both parents can help determine the trait in the progeny, both parents must be contributing a copy of the same gene. This means that each pea plant must have two sets of all genes, one inherited from each parent. For this mechanism to work, each germ cell must have only one gene set.

How do germ-cells make a single set of genes from the normal two copies that all other cells in the body have? If progeny plants inherited a single whole gene set from each parent, then the experiment explained in Fig. 9.5 cannot work. This is because the two characteristics 'R' and 'y' would then be linked to each other and cannot be independently

Heredity and Evolution

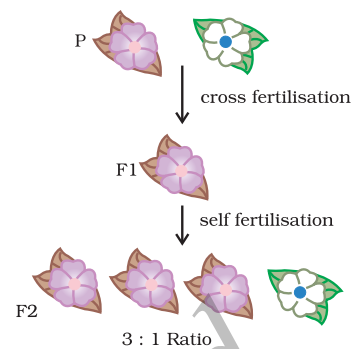

Figure 9.4

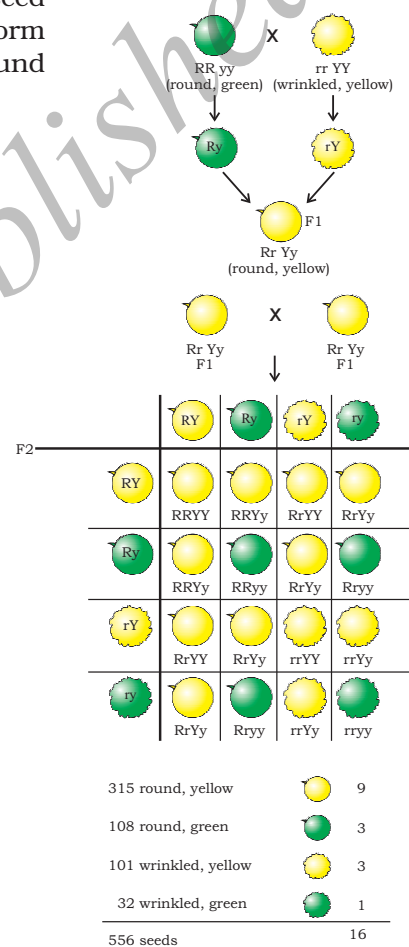

Figure 9.5 Independent inheritance of two separate traits, shape and colour of seeds

inherited. This is explained by the fact that each gene set is present, not as a single long thread of DNA, but as separate independent pieces, each called a chromosome. Thus, each cell will have two copies of each chromosome, one each from the male and female parents. Every germ-cell will take one chromosome from each pair and these may be of either maternal or paternal origin. When two germ cells combine, they will restore the normal number of chromosomes in the progeny, ensuring the stability of the DNA of the species. Such a mechanism of inheritance explains the results of the Mendel experiments, and is used by all sexually reproducing organisms. But asexually reproducing organisms also follow similar rules of inheritance. Can we work out how their inheritance might work?

9.2.4 Sex Determination

We have discussed the idea that the two sexes participating in sexual reproduction must be somewhat different from each other for a number of reasons. How is the sex of a newborn individual determined? Different species use very different strategies for this. Some rely entirely on environmental cues. Thus, in some animals like a few reptiles, the temperature at which fertilised eggs are kept determines whether the animals developing in the eggs will be male or female. In other animals, such as snails, individuals can change sex, indicating that sex is not genetically determined. However, in human beings, the sex of the individual is largely genetically determined. In other words, the genes inherited from our parents decide whether we will be boys or girls. But so far, we have assumed that similar gene sets are inherited from both parents. If that is the case, how can genetic inheritance determine sex?

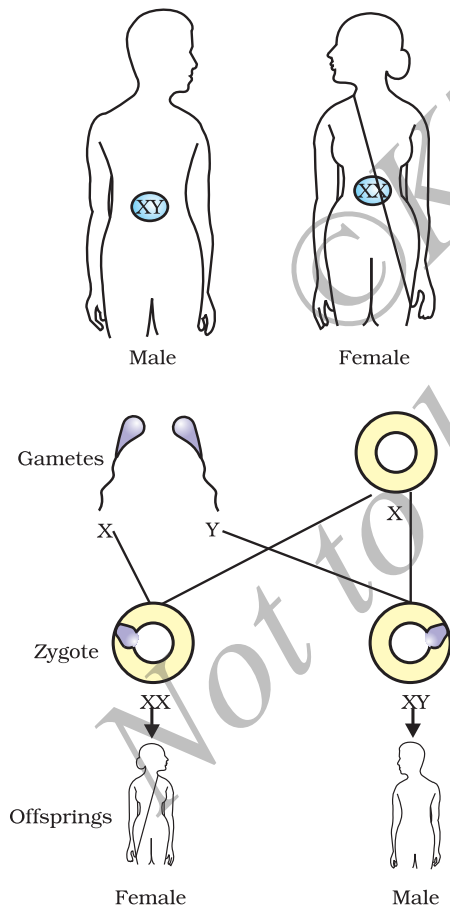

Figure 9.6
Sex determination in human beings

The explanation lies in the fact that all human chromosomes are not paired. Most human chromosomes have a maternal and a paternal copy, and we have 22 such pairs. But one pair, called the sex chromosomes, is odd in not always being a perfect pair. Women have a perfect pair of sex chromosomes, both called X. But men have a mismatched pair in which one is a normal-sized X while the other is a short one called Y. So women are XX, while men are XY. Now, can we work out what the inheritance pattern of X and Y will be?

As Fig. 9.6 shows, half the children will be boys and half will be girls. All children will inherit an X chromosome from their mother regardless of whether they are boys or girls. Thus, the sex of the children will be determined by what they inherit from their father. A child who inherits an X chromosome from her father will be a girl, and one who inherits a Y chromosome from him will be a boy.

Q U E S T I O N S

1. How do Mendel's experiments show that traits may be dominant or recessive?
2. How do Mendel's experiments show that traits are inherited independently?
3. A man with blood group A marries a woman with blood group O and their daughter has blood group O. Is this information enough to tell you which of the traits – blood group A or O – is dominant? Why or why not?
4. How is the sex of the child determined in human beings?

9.3 EVOLUTION

We have noted that there is an inbuilt tendency to variation during reproduction, both because of errors in DNA copying, and as a result of sexual reproduction. Let us now look at some consequences of this tendency.

9.3.1 An Illustration

Consider a group of twelve red beetles. They live, let us assume, in some bushes with green leaves. Their population will grow by sexual reproduction, and therefore, can generate variations. Let us imagine also that crows eat these beetles. The more beetles the crows eat, the fewer beetles are available to reproduce. Now, let us think about some different situations (Fig. 9.7) that can develop in this beetle population.

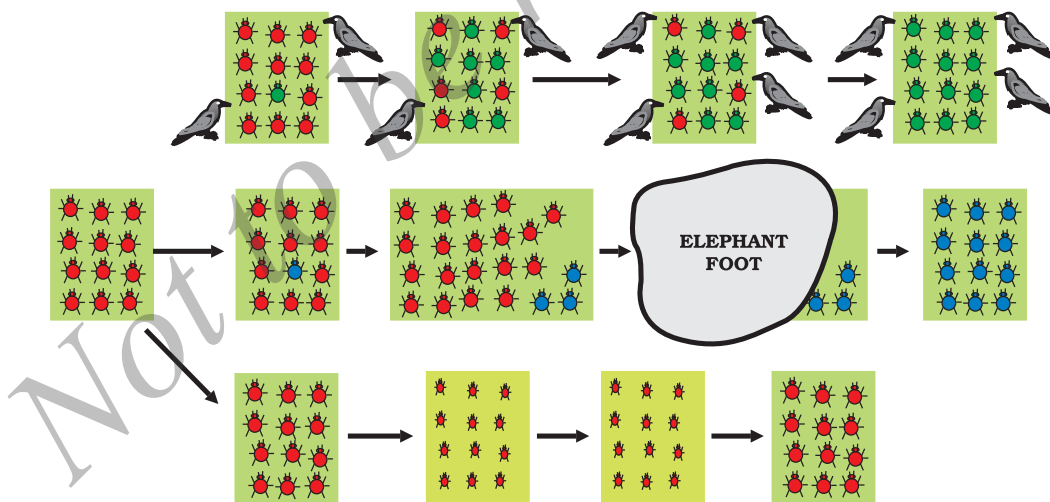

Figure 9.7 Variations in a population – inherited and otherwise

In the first situation, a colour variation arises during reproduction, so that there is one beetle that is green in colour instead of red. This beetle, moreover, can pass the colour on to its progeny, so that all its

progeny beetles are green. Crows cannot see green-coloured beetles on the green leaves of the bushes, and therefore cannot eat them. What happens then? The progeny of green beetles is not eaten, while the progeny of red beetles continues to be eaten. As a result, there are more and more green beetles than red ones in the beetle population.

In a second situation, again, a colour variation arises during reproduction, but now it results in a beetle that is blue in colour instead of red. This beetle can also pass the colour on to its progeny, so that all its progeny beetles are blue. Crows can see blue-coloured beetles in the green leaves of the bushes as well as they can see red ones, and therefore can eat them. What happens initially? In the population, as it expands, there are a few blue beetles, but most are red. But at this point, an elephant comes by, and stamps on the bushes where the beetles live. This kills most of the beetles. By chance, the few beetles that have survived are mostly blue. The beetle population slowly expands again, but now, the beetles in the population are mostly blue.

It is obvious that in both situations, what started out as a rare variation came to be a common characteristic in the population. In other words, the frequency of an inherited trait changed over generations. Since genes control traits, we can say that the frequency of certain genes in a population changed over generations. This is the essence of the idea of evolution.

But there are interesting differences, too, in the two situations. In the first case, the variation became common because it gave a survival advantage. In other words, it was naturally selected. We can see that the natural selection is exerted by the crows. The more crows there are, the more red beetles would be eaten, and the more the proportion of green beetles in the population would be. Thus, natural selection is directing evolution in the beetle population. It results in adaptations in the beetle population to fit their environment better.

In the second situation, the colour change gave no survival advantage. Instead, it was simply a matter of accidental survival of beetles of one colour that changed the common characteristic of the resultant population. The elephant would not have caused such major havoc in the beetle population if the beetle population had been very large. So, accidents in small populations can change the frequency of some genes in a population, even if they give no survival advantage. This is the notion of genetic drift, which provides diversity without any adaptations.

Now consider a third situation. In this, as the beetle population begins to expand, the bushes start suffering from a plant disease. The amount of leaf material for the beetles is reduced. The beetles are poorly nourished as a result. The average weight of adult beetles decreases from what it used to be when leaves were plentiful, but there is no genetic change occurring. After a few years and a few beetle generations of such scarcity, the plant disease is eliminated. There is a lot of leaf food. At this time, what would we expect the weight of the beetles to be?

9.3.2 Acquired and Inherited Traits

We discussed the idea that the germ cells of sexually reproducing populations are made in specialised reproductive tissue. If the weight of the beetle is reduced because of starvation, that will not change the DNA of the germ cells. Therefore, low weight is not a trait that can be inherited by the progeny of a starving beetle. Therefore, even if some generations of beetles are low in weight because of starvation, that is not an example of evolution, since the change is not inherited over generations. Change in non-reproductive tissues cannot be passed on to the DNA of the germ cells. Therefore the experiences of an individual during its lifetime cannot be passed on to its progeny, and cannot direct evolution.

Consider another example of how an individual cannot pass on to its progeny the experiences of its lifetime. If we breed a group of mice, all their progeny will have tails, as expected. Now, if the tails of these mice are removed by surgery in each generation, do these tailless mice have tailless progeny? The answer is no, and it makes sense because removal of the tail cannot change the genes of the germ cells of the mice.

Charles Robert Darwin (1809–1882)

Charles Darwin set out on a voyage when he was 22 years old. The five-year voyage took him to South America and the islands off its coast. The studies that he conducted during this voyage were to change forever the way we look at the variety of life on earth. Interestingly, after he got back to England, he never left its shores again. He stayed at home and conducted various experiments that led him to formulate his hypothesis that evolution took place due to natural selection. He did not know the mechanism whereby variations arose in the species. He would have been enlightened by Mendel's experiments, but these two gentlemen did not know of each other or their work!

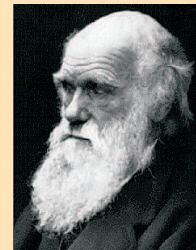

We often associate Darwin solely with the theory of evolution. But he was an accomplished naturalist, and one of the studies he conducted was to do with the role of earthworms in soil fertility.

This is the reason why the ideas of heredity and genetics that we have discussed earlier are so essential for understanding evolution. Even Charles Darwin, who came up with the idea of evolution of species by natural selection in the nineteenth century, could not work out the mechanism. It is ironic that he could have done so if he had seen the significance of the experiments his Austrian contemporary, Gregor Mendel, was doing. But then, Mendel too did not notice Darwin's work as relevant to his!

Origin of life on earth

Darwin's theory of evolution tells us how life evolved from simple to more complex forms and Mendel's experiments give us the mechanism for the inheritance of traits from one generation to the next. But neither tells us anything about how life began on earth in the first place.

Do You Know?

J.B.S. Haldane, a British scientist (who became a citizen of India later), suggested in 1929 that life must have developed from the simple inorganic molecules which were present on earth soon after it was formed. He speculated that the conditions on earth at that time, which were far from the conditions we see today, could have given rise to more complex organic molecules that were necessary for life. The first primitive organisms would arise from further chemical synthesis.

How did these organic molecules arise? An answer was suggested by the experiment conducted by Stanley L. Miller and Harold C. Urey in 1953. They assembled an atmosphere similar to that thought to exist on early earth (this had molecules like ammonia, methane and hydrogen sulphide, but no oxygen) over water. This was maintained at a temperature just below 100 C and sparks were passed through the mixture of gases to simulate lightning. At the end of a week, 15% of the carbon (from methane) had been converted to simple compounds of carbon including amino acids which make up protein molecules. So, can life arise afresh on earth even now?

Q U E S T I O N S

1. What are the different ways in which individuals with a particular trait may increase in a population?
2. Why are traits acquired during the life-time of an individual not inherited?
3. Why are the small numbers of surviving tigers a cause of worry from the point of view of genetics?

9.4 SPECIATION

What we have seen so far is micro-evolution. That means that the changes are small, even though they are significant. Also, they simply change the common characteristics of a particular species. But this does not properly explain as to how new species come into existence. That can be said to have happened only if this group of beetles we are thinking about, splits into two populations that cannot reproduce with each other. When this happens, they can be called two independent species. So, can we extend the reasoning we have used above to explain such speciation?

Consider what would happen if the bushes the beetles feed on are spread widely over a mountain range. The beetle population becomes very large as a result. But individual beetles feed mostly on a few nearby bushes throughout their lifetime. They do not travel far. So, in this huge population of beetles, there will be sub-populations in neighbourhoods. Since male and female beetles have to meet for reproduction to happen, most reproduction will be within these sub-populations. Of course, an occasional adventurous beetle might go from one site to another. Or a beetle is picked up by a crow from one site and dropped in the other site without being eaten. In either case, the migrant beetle will reproduce with the local population. This will result in the genes of the migrant beetle entering a new population. This kind of gene flow is bound to

happen between populations that are partly, but not completely separated. If, however, between two such sub-populations a large river comes into existence, the two populations will be further isolated. The levels of gene flow between them will decrease even further.

Over generations, genetic drift will accumulate different changes in each sub-population. Also, natural selection may also operate differently in these different geographic locations. Thus, for example, in the territory of one sub-population, crows are eliminated by eagles. But this does not happen for the other sub-population, where crow numbers are very high. As a result, the green variation will not be selected at the first site, while it will be strongly selected at the second.

Together, the processes of genetic drift and natural selection will result in these two isolated sub-populations of beetles becoming more and more different from each other. Eventually, members of these two groups will be incapable of reproducing with each other even if they happen to meet.

There can be a number of ways by which this can happen. If the DNA changes are severe enough, such as a change in the number of chromosomes, eventually the germ cells of the two groups cannot fuse with each other. Or a new variation emerges in which green females will not mate with red males, but only with green males. This allows very strong natural selection for greenness. Now, if such a green female beetle meets a red male from the other group, her behaviour will ensure that there is no reproduction between them. Effectively, new species of beetles are being generated.

Q U E S T I O N S

1. What factors could lead to the rise of a new species?
2. Will geographical isolation be a major factor in the speciation of a self-pollinating plant species? Why or why not?
3. Will geographical isolation be a major factor in the speciation of an organism that reproduces asexually? Why or why not?



9.5 EVOLUTION AND CLASSIFICATION

Based on these principles, we can work out the evolutionary relationships of the species we see around us. It is a sort of going backwards in time. We can do this by identifying hierarchies of characteristics between species. In order to understand this process, let us think back to our discussion on the classification of organisms in Class IX.

Similarities among organisms will allow us to group them and then study the groups. For this, which characteristics decide more fundamental differences among organisms, and which ones decide less basic differences? What is meant by 'characteristics', anyway? Characteristics are details of appearance or behaviour; in other words, a particular form or a particular function. That we have four limbs is thus a characteristic. That plants can do photosynthesis is also a characteristic.

Some basic characteristics will be shared by most organisms. The cell is the basic unit of life in all organisms. The characteristics in the next level of classification would be shared by most, but not all organisms. A basic characteristic of cell design that differs among different organisms is whether the cell has a nucleus. Bacterial cells do not, while the cells of most other organisms do. Among organisms with nucleated cells, which ones are unicellular and which ones multi-cellular? That property marks a very basic difference in body design, because of specialisation of cell types and tissues. Among multi-cellular organisms, whether they can undertake photosynthesis or not will provide the next level of classification. Among the multi-cellular organisms that cannot do photosynthesis, whether the skeleton is inside the body or around the body will mark another fundamental design difference. We can see that, even in these few questions that we have asked, a hierarchy is developing that allows us to make classification groups.

The more characteristics two species will have in common, the more closely they are related. And the more closely they are related, the more recently they will have had a common ancestor. An example will help. A brother and a sister are closely related. They have common ancestors in the first generation before them, namely, their parents. A girl and her first cousin are also related, but less than the girl and her brother. This is because cousins have common ancestors, their grandparents, in the second generation before them, not in the first one. We can now appreciate that classification of species is in fact a reflection of their evolutionary relationship.

We can thus build up small groups of species with recent common ancestors, then super-groups of these groups with more distant common ancestors, and so on. In theory, we can keep going backwards like this until we come to the notion of a single species at the very beginning of evolutionary time. If that is the case, then at some point in the history of the earth, non-living material must have given rise to life. There are many theories about how this might have happened. It would be interesting to come up with theories of our own!

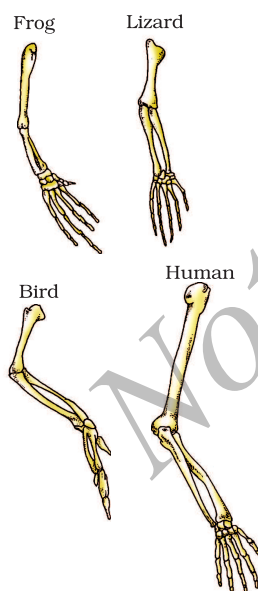

Figure 9.8
Homologous organs

9.5.1 Tracing Evolutionary Relationships

When we try to follow evolutionary relationships, how do we identify characteristics as common? These characteristics in different organisms would be similar because they are inherited from a common ancestor. As an example, consider the fact that mammals have four limbs, as do birds, reptiles and amphibians (Fig. 9.8). The basic structure of the limbs is similar though it has been modified to perform different functions in various vertebrates. Such a homologous characteristic helps to identify an evolutionary relationship between apparently different species.

However, all similarities simply in organ shape are not necessarily because of common ancestry. What would we think about the wings of

birds and bats, for example (Fig. 9.9)? Birds and bats have wings, but squirrels and lizards do not. So are birds and bats more closely related to each other than to squirrels or lizards?

Before we jump to this conclusion, let us look at the wings of birds and bats more closely. When we do that, we find that the wings of bats are skin folds stretched mainly between elongated fingers. But the wings of birds are a feathery covering all along the arm. The designs of the two wings, their structure and components, are thus very different. They look similar because they have a common use for flying, but their origins are not common. This makes them analogous characteristics, rather than homologous characteristics. It would now be interesting to think about whether bird arms and bat arms should be considered homologous or analogous!

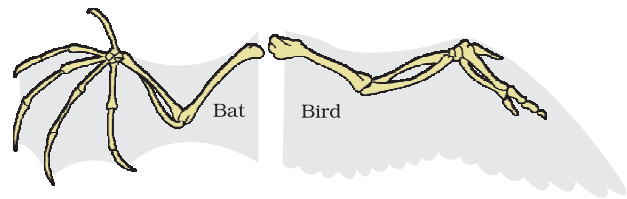

Figure 9.9
Analogous organs – The wing of a bat and the wing of a bird

9.5.2 Fossils

Such studies of organ structure can be done not only on current species, but also on species that are no longer alive. How do we know that these extinct species ever existed? We know this from finding fossils (Fig. 9.10). What are fossils? Usually, when organisms die, their bodies will decompose and be lost. But every once in a while, the body or at least some parts may be in an environment that does not let it decompose completely. If a dead insect gets caught in hot mud, for example, it will not decompose quickly, and the mud will eventually harden and retain the impression of the body parts of the insect. All such preserved traces of living organisms are called fossils.



Fossil – tree trunk



Fossil – invertebrate (Ammonite)



Fossil – invertebrate (Trilobite)



Fossil – fish (Knightia)



Fossil – dinosaur skull (Rajasaurus)

Figure 9.10 Various kind of fossils. Note the different appearances and degrees of detail and preservation. The dinosaur skull fossil shown was found only a few years ago in the Narmada valley.

How do we know how old the fossils are? There are two components to this estimation. One is relative. If we dig into the earth and start finding fossils, it is reasonable to suppose that the fossils we find closer to the surface are more recent than the fossils we find in deeper layers. The second way of dating fossils is by detecting the ratios of different isotopes of the same element in the fossil material. It would be interesting to find out exactly how this method works!

How do fossils form layer by layer?



Let us start 100 million years ago. Some invertebrates on the sea-bed die, and are buried in the sand. More sand accumulates, and sandstone forms under pressure.

Millions of years later, dinosaurs living in the area die, and their bodies, too, are buried in mud. This mud is also compressed into rock, above the rock containing the earlier invertebrate fossils.

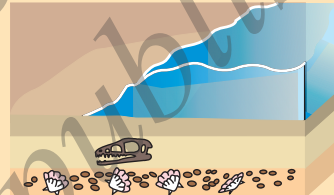

Again millions of years later, the bodies of horse-like creatures dying in the area are fossilised in rocks above these earlier rocks.

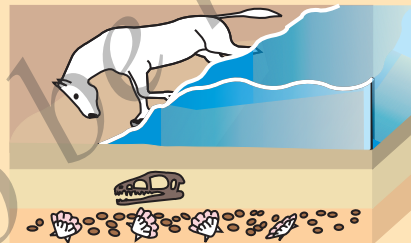

Much later, by erosion or water flow wears away some of the rock and exposes the horse-like fossils. As we dig deeper, we will find older and older fossils.

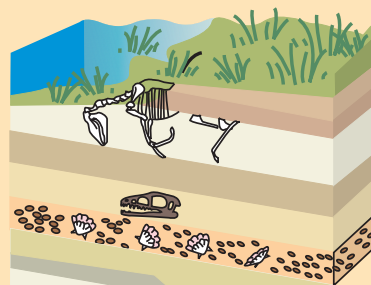

Do You Know?

9.5.3 Evolution by Stages

A question that arises here is – if complicated organs, such as the eye, are selected for the advantage they provide, how can they be generated by a single DNA change? Surely such complex organs will be created bit-by-bit over generations? But how can each intermediate change be selected for? There are a number of possible explanations. Even an intermediate stage (Fig. 9.11), such as a rudimentary eye, can be useful to some extent. This might be enough to give a fitness advantage. In fact, the eye – like the wing – seems to be a very popular adaptation. Insects have them, so does an octopus, and so do vertebrates. And the structure of the eye in each of these organisms is different – enough for them to have separate evolutionary origins.

Also, a change that is useful for one property to start with can become useful later for quite a different function. Feathers, for example, can start out as providing insulation in cold weather (Fig. 9.12). But later, they might become useful for flight. In fact, some dinosaurs had feathers, although they could not fly using the feathers. Birds seem to have later adapted the feathers to flight. This, of course, means that birds are very closely related to reptiles, since dinosaurs were reptiles!

It is all very well to say that very dissimilar-looking structures evolve from a common ancestral design. It is true that analysis of the organ structure in fossils allows us to make estimates of how far back evolutionary relationships go. But those are guesses about what happened in history. Are there any current examples of such a process? The wild cabbage plant is a good example. Humans have, over more than two thousand years, cultivated wild cabbage as a food plant, and generated different vegetables from it by selection (see Fig. 9.13). This is, of course, artificial selection rather than natural selection. So some farmers have wanted to select for very short distances between leaves, and have bred the cabbage we eat. Some have wanted to select for arrested flower development, and have bred broccoli, or for sterile flowers, and have made the cauliflower. Some have selected for swollen parts, and come up with kohlrabi. Some have simply looked for slightly larger leaves, and come up with a leafy vegetable called kale. Would we have thought that all these structures are descended from the same ancestor if we had not done it ourselves?

Heredity and Evolution

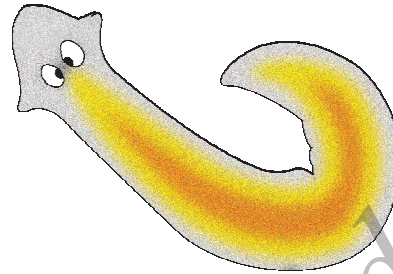
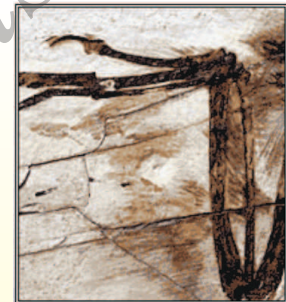

Figure 9.11
A flatworm named *Planaria* has very simple 'eyes' that are really just eye-spots which detect light.



This is a small dinosaur from the Dromaeosaur family.



Feather imprints were preserved along this dinosaur's bones. Here we can see feathers on the forearm.

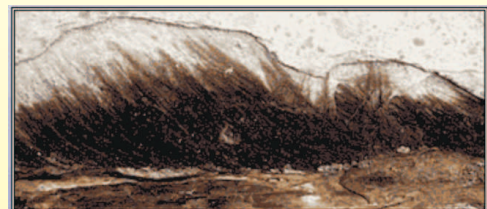

Here's a close-up of the fossil's head feathers.

This dinosaur could not fly, and it is possible that the evolution of feathers had nothing to do with flight.

Figure 9.12
Dinosaurs and the evolution of feathers

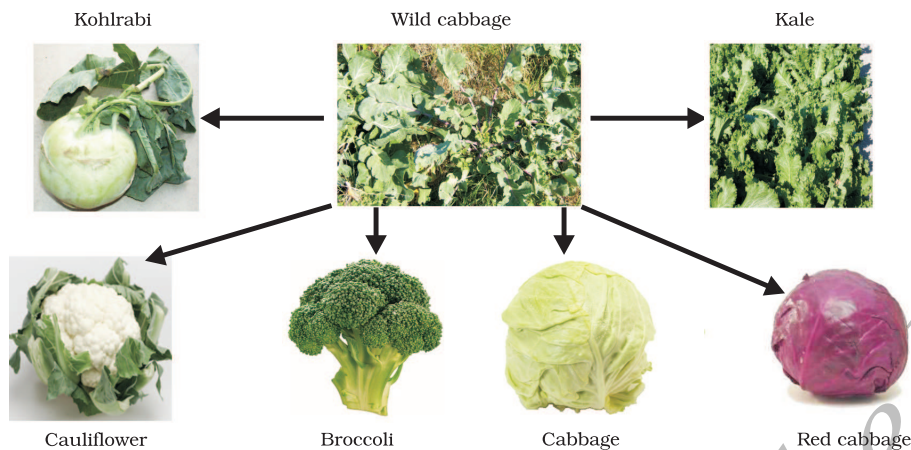

Figure 9.13 Evolution of wild cabbage!

Another way of tracing evolutionary relationships depends on the original idea that we started with. That idea was that changes in DNA during reproduction are the basic events in evolution. If that is the case, then comparing the DNA of different species should give us a direct estimate of how much the DNA has changed during the formation of these species. This method is now extensively used to define evolutionary relationships.

More to Know!

Molecular phylogeny

We have been discussing how changes in the DNA during cell division would lead to changes in the proteins that are made from this new DNA. Another point that has been made is that these changes would accumulate from one generation to the next. Could this be used to trace the changes in DNA backwards in time and find out where each change diverged from the other? Molecular phylogeny does exactly this. This approach is based on the idea that organisms which are more distantly related will accumulate a greater number of differences in their DNA. Such studies trace the evolutionary relationships and it has been highly gratifying to find that the relationships among different organisms shown by molecular phylogeny match the classification scheme that we learnt in Class IX.

Q U E S T I O N S

1. Give an example of characteristics being used to determine how close two species are in evolutionary terms.
2. Can the wing of a butterfly and the wing of a bat be considered homologous organs? Why or why not?
3. What are fossils? What do they tell us about the process of evolution?



9.6 EVOLUTION SHOULD NOT BE EQUATED WITH 'PROGRESS'

In an exercise of tracing the family trees of species, we need to remember certain things. Firstly, there are multiple branches possible at each and

every stage of this process. So it is not as if one species is eliminated to give rise to a new one. A new species has emerged. But that does not necessarily mean, like the beetle example we have been thinking about, that the old species will disappear. It will all depend on the environment. Also, it is not as if the newly generated species are in any way 'better' than the older one. It is just that natural selection and genetic drift have together led to the formation of a population that cannot reproduce with the original one. So, for example, it is not true that human beings have evolved from chimpanzees. Rather, both human beings and chimpanzees have a common ancestor a long time ago. That common ancestor is likely to have been neither human or chimpanzee. Also, the first step of separation from that ancestor is unlikely to have resulted in modern chimpanzees and human beings. Instead, the two resultant species have probably evolved in their own separate ways to give rise to the current forms.

In fact, there is no real 'progress' in the idea of evolution. Evolution is simply the generation of diversity and the shaping of the diversity by environmental selection. The only progressive trend in evolution seems to be that more and more complex body designs have emerged over time. However, again, it is not as if the older designs are inefficient! So many of the older and simpler designs still survive. In fact, one of the simplest life forms – bacteria – inhabit the most inhospitable habitats like hot springs, deep-sea thermal vents and the ice in Antarctica. In other words, human beings are not the pinnacle of evolution, but simply yet another species in the teeming spectrum of evolving life.

9.6.1 Human Evolution

The same tools for tracing evolutionary relationships – excavating, time-dating and studying fossils, as well as determining DNA sequences – have been used for studying human evolution. There is a great diversity of human forms and features across the planet. So much so that, for a long time, people used to talk about human 'races'. Skin colour used to be the commonest way of identifying these so-called races. Some were called yellow, some black, white or brown. A major question debated for a long time was, have these apparent groups evolved differently? Over recent years, the evidence has become very clear. The answer is that there is no biological basis to the notion of human races. All humans are a single species.

Not only that, regardless of where we have lived for the past few thousand years, we all come from Africa. The earliest members of the human species, *Homo sapiens*, can be traced there. Our genetic footprints can be traced back to our African roots. A couple of hundred thousand years ago, some of our ancestors left Africa while others stayed on. While

Heredity and Evolution

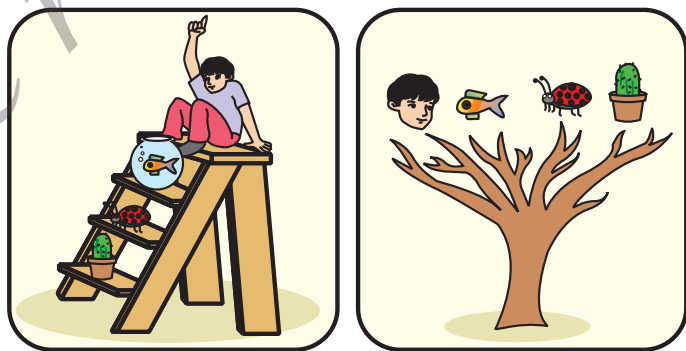

Figure 9.14
Evolution —
Ladder versus Tree

the residents spread across Africa, the migrants slowly spread across the planet – from Africa to West Asia, then to Central Asia, Eurasia, South Asia, East Asia. They travelled down the islands of Indonesia and the Philippines to Australia, and they crossed the Bering land bridge to the Americas. They did not go in a single line, so they were not travelling for the sake of travelling, obviously. They went forwards and backwards, with groups sometimes separating from each other, sometimes coming back to mix with each other, even moving in and out of Africa. Like all other species on the planet, they had come into being as an accident of evolution, and were trying to live their lives the best they could.

Q U E S T I O N S

1. Why are human beings who look so different from each other in terms of size, colour and looks said to belong to the same species?
2. In evolutionary terms, can we say which among bacteria, spiders, fish and chimpanzees have a 'better' body design? Why or why not?

What you have learnt

- Variations arising during the process of reproduction can be inherited.
- These variations may lead to increased survival of the individuals.
- Sexually reproducing individuals have two copies of genes for the same trait. If the copies are not identical, the trait that gets expressed is called the dominant trait and the other is called the recessive trait.
- Traits in one individual may be inherited separately, giving rise to new combinations of traits in the offspring of sexual reproduction.
- Sex is determined by different factors in various species. In human beings, the sex of the child depends on whether the paternal chromosome is X (for girls) or Y (for boys).
- Variations in the species may confer survival advantages or merely contribute to the genetic drift.
- Changes in the non-reproductive tissues caused by environmental factors are not inheritable.
- Speciation may take place when variation is combined with geographical isolation.
- Evolutionary relationships are traced in the classification of organisms.
- Tracing common ancestors back in time leads us to the idea that at some point of time, non-living material must have given rise to life.
- Evolution can be worked out by the study of not just living species, but also fossils.
- Complex organs may have evolved because of the survival advantage of even the intermediate stages.
- Organs or features may be adapted to new functions during the course of evolution. For example, feathers are thought to have been initially evolved for warmth and later adapted for flight.

- Evolution cannot be said to 'progress' from 'lower' forms to 'higher' forms. Rather, evolution seems to have given rise to more complex body designs even while the simpler body designs continue to flourish.
- Study of the evolution of human beings indicates that all of us belong to a single species that evolved in Africa and spread across the world in stages.

E X E R C I S E S

1. A Mendelian experiment consisted of breeding tall pea plants bearing violet flowers with short pea plants bearing white flowers. The progeny all bore violet flowers, but almost half of them were short. This suggests that the genetic make-up of the tall parent can be depicted as
 - (a) TTWW
 - (b) TTww
 - (c) TtWW
 - (d) TtWw
2. An example of homologous organs is
 - (a) our arm and a dog's fore-leg.
 - (b) our teeth and an elephant's tusks.
 - (c) potato and runners of grass.
 - (d) all of the above.
3. In evolutionary terms, we have more in common with
 - (a) a Chinese school-boy.
 - (b) a chimpanzee.
 - (c) a spider.
 - (d) a bacterium.
4. A study found that children with light-coloured eyes are likely to have parents with light-coloured eyes. On this basis, can we say anything about whether the light eye colour trait is dominant or recessive? Why or why not?
5. How are the areas of study – evolution and classification – interlinked?
6. Explain the terms analogous and homologous organs with examples.
7. Outline a project which aims to find the dominant coat colour in dogs.
8. Explain the importance of fossils in deciding evolutionary relationships.
9. What evidence do we have for the origin of life from inanimate matter?
10. Explain how sexual reproduction gives rise to more viable variations than asexual reproduction. How does this affect the evolution of those organisms that reproduce sexually?
11. How is the equal genetic contribution of male and female parents ensured in the progeny?
12. Only variations that confer an advantage to an individual organism will survive in a population. Do you agree with this statement? Why or why not?



CHAPTER 10

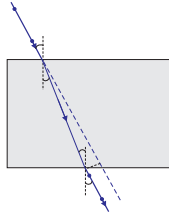

Light – Reflection and Refraction

We see a variety of objects in the world around us. However, we are unable to see anything in a dark room. On lighting up the room, things become visible. What makes things visible? During the day, the sunlight helps us to see objects. An object reflects light that falls on it. This reflected light, when received by our eyes, enables us to see things. We are able to see through a transparent medium as light is transmitted through it. There are a number of common wonderful phenomena associated with light such as image formation by mirrors, the twinkling of stars, the beautiful colours of a rainbow, bending of light by a medium and so on. A study of the properties of light helps us to explore them.

By observing the common optical phenomena around us, we may conclude that light seems to travel in straight lines. The fact that a small source of light casts a *sharp* shadow of an opaque object points to this straight-line path of light, usually indicated as a ray of light.

More to Know!

If an opaque object on the path of light becomes *very small*, light has a tendency to bend around it and not walk in a straight line – an effect known as the diffraction of light. Then the straight-line treatment of optics using rays fails. To explain phenomena such as diffraction, light is thought of as a wave, the details of which you will study in higher classes. Again, at the beginning of the 20th century, it became known that the wave theory of light often becomes inadequate for treatment of the interaction of light with matter, and light often behaves somewhat like a *stream of particles*. This confusion about the true nature of light continued for some years till a modern quantum theory of light emerged in which light is neither a 'wave' nor a 'particle' – the new theory reconciles the particle properties of light with the wave nature.

In this Chapter, we shall study the phenomena of reflection and refraction of light using the straight-line propagation of light. These basic concepts will help us in the study of some of the optical phenomena in nature. We shall try to understand in this Chapter the reflection of light by spherical mirrors and refraction of light and their application in real life situations.

10.1 REFLECTION OF LIGHT

A highly polished surface, such as a mirror, reflects most of the light falling on it. You are already familiar with the laws of reflection of light.

Let us recall these laws –

- (i) The angle of incidence is equal to the angle of reflection, and
- (ii) The incident ray, the normal to the mirror at the point of incidence and the reflected ray, all lie in the same plane.

These laws of reflection are applicable to all types of reflecting surfaces including spherical surfaces. You are familiar with the formation of image by a plane mirror. What are the properties of the image? Image formed by a plane mirror is always virtual and erect. The size of the image is equal to that of the object. The image formed is as far behind the mirror as the object is in front of it. Further, the image is laterally inverted. How would the images be when the reflecting surfaces are curved? Let us explore.

Activity 10.1

- Take a large shining spoon. Try to view your face in its curved surface.
- Do you get the image? Is it smaller or larger?
- Move the spoon slowly away from your face. Observe the image. How does it change?
- Reverse the spoon and repeat the Activity. How does the image look like now?
- Compare the characteristics of the image on the two surfaces.

The curved surface of a shining spoon could be considered as a curved mirror. The most commonly used type of curved mirror is the spherical mirror. The reflecting surface of such mirrors can be considered to form a part of the surface of a sphere. Such mirrors, whose reflecting surfaces are spherical, are called spherical mirrors. We shall now study about spherical mirrors in some detail.

10.2 SPHERICAL MIRRORS

The reflecting surface of a spherical mirror may be curved inwards or outwards. A spherical mirror, whose reflecting surface is curved inwards, that is, faces towards the centre of the sphere, is called a concave mirror. A spherical mirror whose reflecting surface is curved outwards, is called a convex mirror. The schematic representation of these mirrors is shown in Fig. 10.1. You may note in these diagrams that the back of the mirror is shaded.

You may now understand that the surface of the spoon curved inwards can be approximated to a concave mirror and the surface of the spoon bulged outwards can be approximated to a convex mirror.

Before we move further on spherical mirrors, we need to recognise and understand the meaning of a few terms. These terms are commonly used in discussions about spherical mirrors. The centre of the reflecting surface of a spherical mirror is a point called the pole. It lies on the surface of the mirror. The pole is usually represented by the letter P.



(a) Concave mirror (b) Convex mirror

Figure 10.1
Schematic representation of spherical mirrors; the shaded side is non-reflecting.

The reflecting surface of a spherical mirror forms a part of a sphere. This sphere has a centre. This point is called the centre of curvature of the spherical mirror. It is represented by the letter C . Please note that the centre of curvature is not a part of the mirror. It lies outside its reflecting surface. The centre of curvature of a concave mirror lies in front of it. However, it lies behind the mirror in case of a convex mirror. You may note this in Fig. 10.2 (a) and (b). The radius of the sphere of which the reflecting surface of a spherical mirror forms a part, is called the radius of curvature of the mirror. It is represented by the letter R . You may note that the distance PC is equal to the radius of curvature. Imagine a straight line passing through the pole and the centre of curvature of a spherical mirror. This line is called the principal axis. Remember that principal axis is normal to the mirror at its pole. Let us understand an important term related to mirrors, through an Activity.

Activity 10.2

CAUTION: Do not look at the Sun directly or even into a mirror reflecting sunlight. It may damage your eyes.

- Hold a concave mirror in your hand and direct its reflecting surface towards the Sun.
- Direct the light reflected by the mirror on to a sheet of paper held close to the mirror.
- Move the sheet of paper back and forth gradually until you find on the paper sheet a bright, sharp spot of light.
- Hold the mirror and the paper in the same position for a few minutes. What do you observe? Why?

The paper at first begins to burn producing smoke. Eventually it may even catch fire. Why does it burn? The light from the Sun is converged at a point, as a sharp, bright spot by the mirror. In fact, this spot of light is the image of the Sun on the sheet of paper. This point is the focus of the concave mirror. The heat produced due to the concentration of sunlight ignites the paper. The distance of this image from the position of the mirror gives the approximate value of focal length of the mirror.

Let us try to understand this observation with the help of a ray diagram.

Observe Fig. 10.2 (a) closely. A number of rays parallel to the principal axis are falling on a concave mirror. Observe the reflected rays. They are all meeting/intersecting at a point on the principal axis of the mirror. This point is called the principal focus of the concave mirror. Similarly, observe Fig. 10.2 (b). How are the rays parallel to the principal axis, reflected by a convex mirror? The reflected rays appear to come from a point on the principal axis. This point is called the principal focus of the convex mirror. The principal focus is represented by the letter F . The distance between the pole and the principal focus of a spherical mirror is called the focal length. It is represented by the letter f .

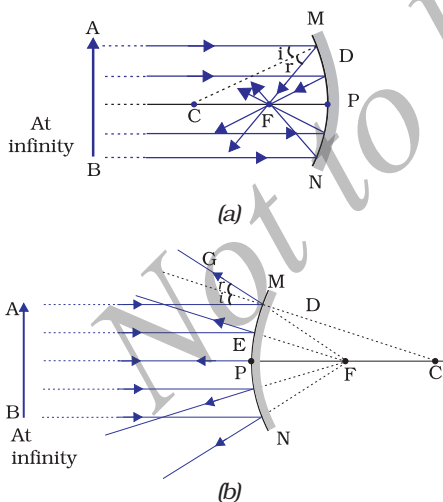

Figure 10.2
(a) Concave mirror
(b) Convex mirror

The reflecting surface of a spherical mirror is by and large spherical. The surface, then, has a circular outline. The diameter of the reflecting surface of spherical mirror is called its aperture. In Fig. 10.2, distance MN represents the aperture. We shall consider in our discussion only such spherical mirrors whose aperture is much smaller than its radius of curvature.

Is there a relationship between the radius of curvature R , and focal length f , of a spherical mirror? For spherical mirrors of small apertures, the radius of curvature is found to be equal to twice the focal length. We put this as $R = 2f$. This implies that the principal focus of a spherical mirror lies midway between the pole and centre of curvature.

10.2.1 Image Formation by Spherical Mirrors

You have studied about the image formation by plane mirrors. You also know the nature, position and relative size of the images formed by them. How about the images formed by spherical mirrors? How can we locate the image formed by a concave mirror for different positions of the object? Are the images real or virtual? Are they enlarged, diminished or have the same size? We shall explore this with an Activity.

Activity 10.3

You have already learnt a way of determining the focal length of a concave mirror. In Activity 10.2, you have seen that the sharp bright spot of light you got on the paper is, in fact, the image of the Sun. It was a tiny, real, inverted image. You got the approximate focal length of the concave mirror by measuring the distance of the image from the mirror.

- Take a concave mirror. Find out its approximate focal length in the way described above. Note down the value of focal length. (You can also find it out by obtaining image of a distant object on a sheet of paper.)
- Mark a line on a Table with a chalk. Place the concave mirror on a stand. Place the stand over the line such that its pole lies over the line.
- Draw with a chalk two more lines parallel to the previous line such that the distance between any two successive lines is equal to the focal length of the mirror. These lines will now correspond to the positions of the points P, F and C, respectively. *Remember – For a spherical mirror of small aperture, the principal focus F lies mid-way between the pole P and the centre of curvature C.*
- Keep a bright object, say a burning candle, at a position far beyond C. Place a paper screen and move it in front of the mirror till you obtain a sharp bright image of the candle flame on it.
- Observe the image carefully. Note down its nature, position and relative size with respect to the object size.
- Repeat the activity by placing the candle – (a) just beyond C, (b) at C, (c) between F and C, (d) at F, and (e) between P and F.
- In one of the cases, you may not get the image on the screen. Identify the position of the object in such a case. Then, look for its virtual image in the mirror itself.
- Note down and tabulate your observations.

You will see in the above Activity that the nature, position and size of the image formed by a concave mirror depends on the position of the object in relation to points P, F and C. The image formed is real for some positions of the object. It is found to be a virtual image for a certain other position. The image is either magnified, reduced or has the same size, depending on the position of the object. A summary of these observations is given for your reference in Table 10.1.

Table 10.1 Image formation by a concave mirror for different positions of the object

Position of the object	Position of the image	Size of the image	Nature of the image
At infinity	At the focus F	Highly diminished, point-sized	Real and inverted
Beyond C	Between F and C	Diminished	Real and inverted
At C	At C	Same size	Real and inverted
Between C and F	Beyond C	Enlarged	Real and inverted
At F	At infinity	Highly enlarged	Real and inverted
Between P and F	Behind the mirror	Enlarged	Virtual and erect

10.2.2 Representation of Images Formed by Spherical Mirrors Using Ray Diagrams

We can also study the formation of images by spherical mirrors by drawing ray diagrams. Consider an extended object, of finite size, placed in front of a spherical mirror. Each small portion of the extended object acts like a point source. An infinite number of rays originate from each of these points. To construct the ray diagrams, in order to locate the image of an object, an arbitrarily large number of rays emanating from a point could be considered. However, it is more convenient to consider only two rays, for the sake of clarity of the ray diagram. These rays are so chosen that it is easy to know their directions after reflection from the mirror.

The intersection of at least two reflected rays give the position of image of the point object. Any two of the following rays can be considered for locating the image.

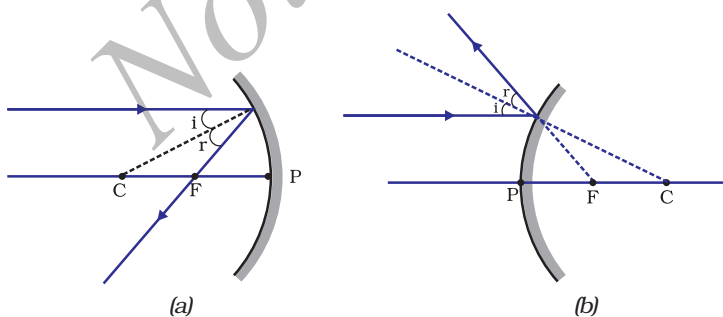

Figure 10.3

- (i) A ray parallel to the principal axis, after reflection, will pass through the principal focus in case of a concave mirror or appear to diverge from the principal focus in case of a convex mirror. This is illustrated in Fig. 10.3 (a) and (b).

- (ii) A ray passing through the principal focus of a concave mirror or a ray which is directed towards the principal focus of a convex mirror, after reflection, will emerge parallel to the principal axis. This is illustrated in Fig.10.4 (a) and (b).

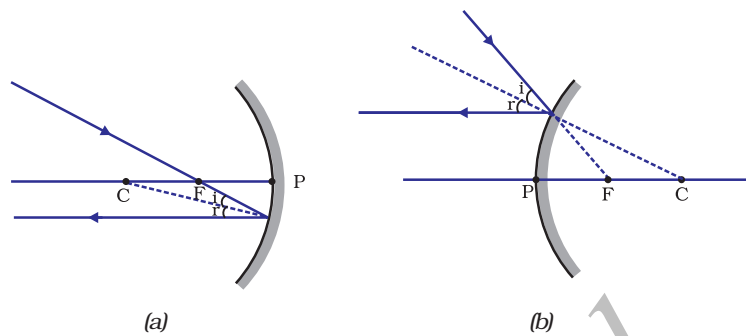

Figure 10.4

- (iii) A ray passing through the centre of curvature of a concave mirror or directed in the direction of the centre of curvature of a convex mirror, after reflection, is reflected back along the same path. This is illustrated in Fig.10.5 (a) and (b). The light rays come back along the same path because the incident rays fall on the mirror along the normal to the reflecting surface.

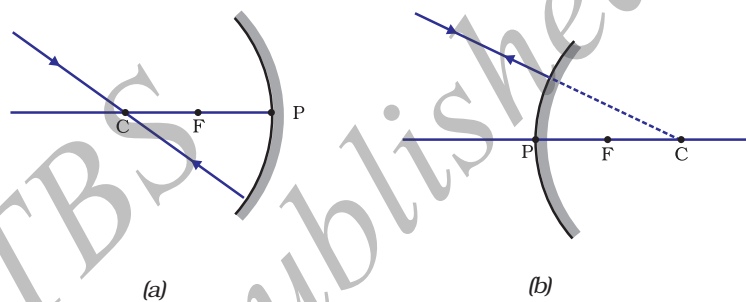

Figure 10.5

- (iv) A ray incident obliquely to the principal axis, towards a point P (pole of the mirror), on the concave mirror [Fig. 10.6 (a)] or a convex mirror [Fig. 10.6 (b)], is reflected obliquely. The incident and reflected rays follow the laws of reflection at the point of incidence (point P), making equal angles with the principal axis.

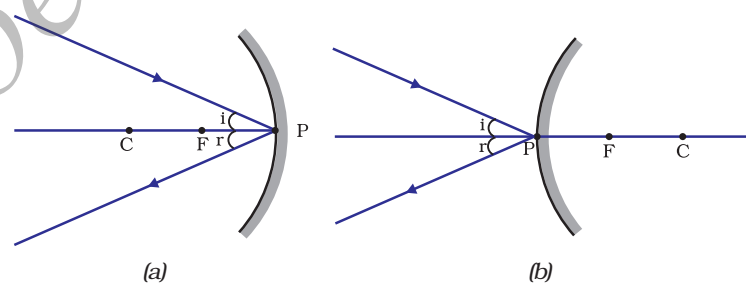

Figure 10.6

Remember that in all the above cases the laws of reflection are followed. At the point of incidence, the incident ray is reflected in such a way that the angle of reflection equals the angle of incidence.

(a) **Image formation by Concave Mirror**

Figure 10.7 illustrates the ray diagrams for the formation of image by a concave mirror for various positions of the object.

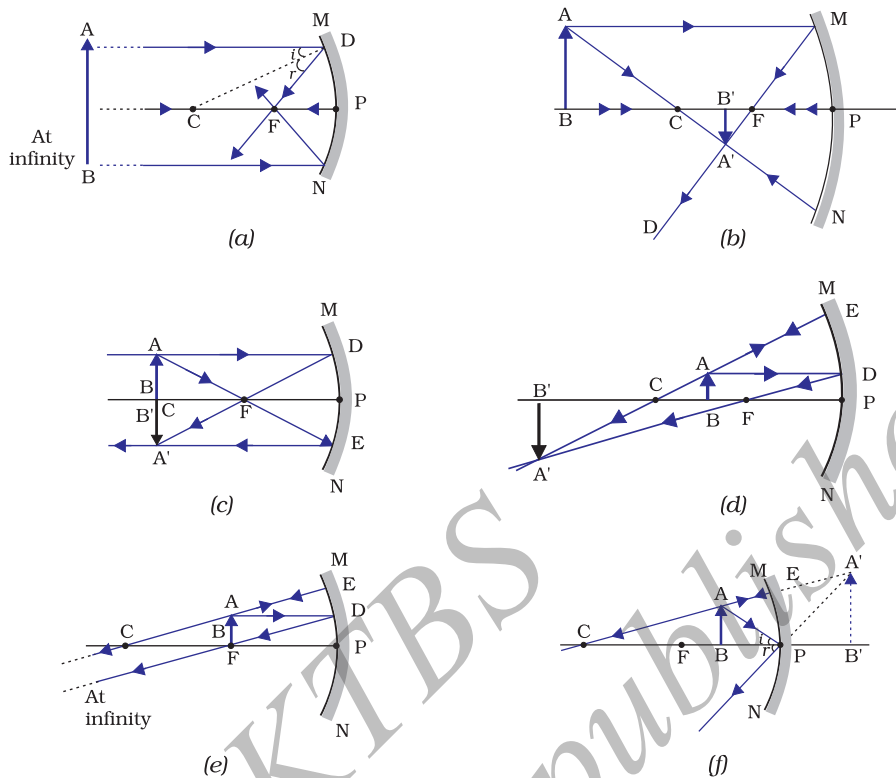

Figure 10.7 Ray diagrams for the image formation by a concave mirror

Activity 10.4

- Draw neat ray diagrams for each position of the object shown in Table 10.1.
- You may take any two of the rays mentioned in the previous section for locating the image.
- Compare your diagram with those given in Fig. 10.7.
- Describe the nature, position and relative size of the image formed in each case.
- Tabulate the results in a convenient format.

Uses of concave mirrors

Concave mirrors are commonly used in torches, search-lights and vehicles headlights to get powerful parallel beams of light. They are often used as shaving mirrors to see a larger image of the face. The dentists use concave mirrors to see large images of the teeth of patients. Large concave mirrors are used to concentrate sunlight to produce heat in solar furnaces.

(b) Image formation by a Convex Mirror

We studied the image formation by a concave mirror. Now we shall study the formation of image by a convex mirror.

Activity 10.5

- Take a convex mirror. Hold it in one hand.
- Hold a pencil in the upright position in the other hand.
- Observe the image of the pencil in the mirror. Is the image erect or inverted? Is it diminished or enlarged?
- Move the pencil away from the mirror slowly. Does the image become smaller or larger?
- Repeat this Activity carefully. State whether the image will move closer to or farther away from the focus as the object is moved away from the mirror?

We consider two positions of the object for studying the image formed by a convex mirror. First is when the object is at infinity and the second position is when the object is at a finite distance from the mirror. The ray diagrams for the formation of image by a convex mirror for these two positions of the object are shown in Fig. 10.8 (a) and (b), respectively. The results are summarised in Table 10.2.

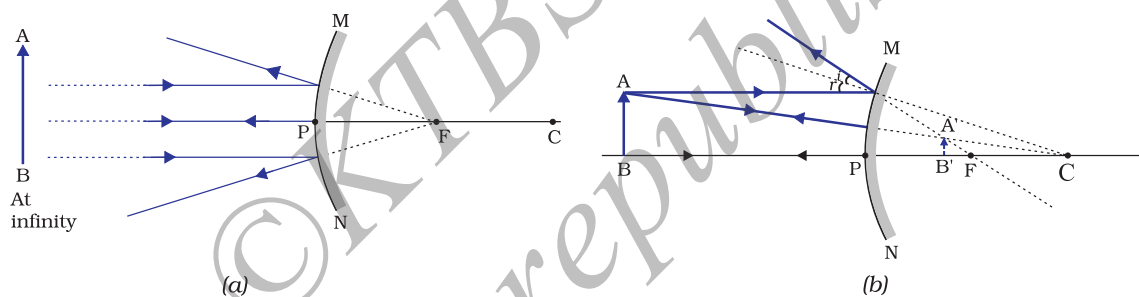

Figure 10.8 Formation of image by a convex mirror

Table 10.2 Nature, position and relative size of the image formed by a convex mirror

Position of the object	Position of the image	Size of the image	Nature of the image
At infinity	At the focus F, behind the mirror	Highly diminished, point-sized	Virtual and erect
Between infinity and the pole P of the mirror	Between P and F, behind the mirror	Diminished	Virtual and erect

You have so far studied the image formation by a plane mirror, a concave mirror and a convex mirror. Which of these mirrors will give the full image of a large object? Let us explore through an Activity.

Activity 10.6

- Observe the image of a distant object, say a distant tree, in a plane mirror.
- Could you see a full-length image?

- Try with plane mirrors of different sizes. Did you see the entire object in the image?
- Repeat this Activity with a concave mirror. Did the mirror show full length image of the object?
- Now try using a convex mirror. Did you succeed? Explain your observations with reason.

You can see a full-length image of a tall building/tree in a small convex mirror. One such mirror is fitted in a wall of Agra Fort facing Taj Mahal. If you visit the Agra Fort, try to observe the full image of Taj Mahal. To view distinctly, you should stand suitably at the terrace adjoining the wall.

Uses of convex mirrors

Convex mirrors are commonly used as rear-view (wing) mirrors in vehicles. These mirrors are fitted on the sides of the vehicle, enabling the driver to see traffic behind him/her to facilitate safe driving. Convex mirrors are preferred because they always give an erect, though diminished, image. Also, they have a wider field of view as they are curved outwards. Thus, convex mirrors enable the driver to view much larger area than would be possible with a plane mirror.

Q U E S T I O N S

1. Define the principal focus of a concave mirror.
2. The radius of curvature of a spherical mirror is 20 cm. What is its focal length?
3. Name a mirror that can give an erect and enlarged image of an object.
4. Why do we prefer a convex mirror as a rear-view mirror in vehicles?

10.2.3 Sign Convention for Reflection by Spherical Mirrors

While dealing with the reflection of light by spherical mirrors, we shall follow a set of sign conventions called the *New Cartesian Sign Convention*. In this convention, the pole (P) of the mirror is taken as the origin (Fig. 10.9). The principal axis of the mirror is taken as the x-axis (XX) of the coordinate system. The conventions are as follows –

- (i) The object is always placed to the left of the mirror. This implies that the light from the object falls on the mirror from the left-hand side.
- (ii) All distances parallel to the principal axis are measured from the pole of the mirror.
- (iii) All the distances measured to the right of the origin (along + x-axis) are taken as positive while those measured to the left of the origin (along – x-axis) are taken as negative.
- (iv) Distances measured perpendicular to and above the principal axis (along + y-axis) are taken as positive.
- (v) Distances measured perpendicular to and below the principal axis (along –y-axis) are taken as negative.

The New Cartesian Sign Convention described above is illustrated in Fig. 10.9 for your reference. These sign conventions are applied to obtain the mirror formula and solve related numerical problems.

10.2.4 Mirror Formula and Magnification

In a spherical mirror, the distance of the object from its pole is called the object distance (u). The distance of the image from the pole of the mirror is called the image distance (v). You already know that the distance of the principal focus from the pole is called the focal length (f). There is a relationship between these three quantities given by the *mirror formula* which is expressed as

$$\frac{1}{v} + \frac{1}{u} = \frac{1}{f} \quad (10.1)$$

This formula is valid in all situations for all spherical mirrors for all positions of the object. You must use the New Cartesian Sign Convention while substituting numerical values for u , v , f , and R in the mirror formula for solving problems.

Magnification

Magnification produced by a spherical mirror gives the relative extent to which the image of an object is magnified with respect to the object size. It is expressed as the ratio of the height of the image to the height of the object. It is usually represented by the letter m .

If h is the height of the object and h' is the height of the image, then the magnification m produced by a spherical mirror is given by

$$m = \frac{\text{Height of the image } (h')}{\text{Height of the object } (h)}$$

$$m = \frac{h'}{h} \quad (10.2)$$

The magnification m is also related to the object distance (u) and image distance (v). It can be expressed as:

$$\text{Magnification } (m) = \frac{h'}{h} = -\frac{v}{u} \quad (10.3)$$

You may note that the height of the object is taken to be positive as the object is usually placed above the principal axis. The height of the image should be taken as positive for virtual images. However, it is to be taken as negative for real images. A negative sign in the value of the magnification indicates that the image is real. A positive sign in the value of the magnification indicates that the image is virtual.

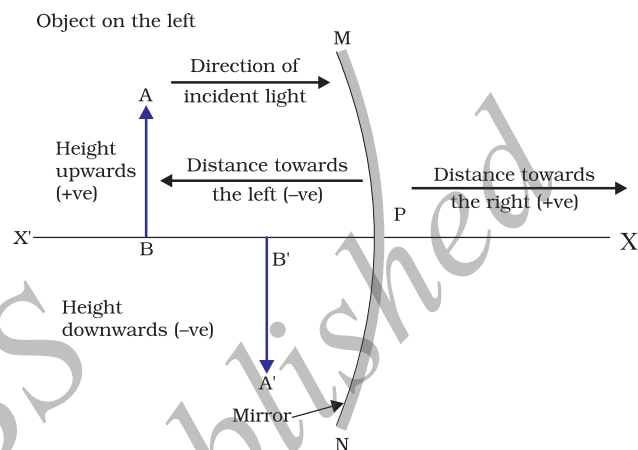

Figure 10.9
The New Cartesian Sign Convention for spherical mirrors

Example 10.1

A convex mirror used for rear-view on an automobile has a radius of curvature of 3.00 m. If a bus is located at 5.00 m from this mirror, find the position, nature and size of the image.

Solution

Radius of curvature, $R = + 3.00$ m;

Object-distance, $u = - 5.00$ m;

Image-distance, $v = ?$

Height of the image, $h' = ?$

Focal length, $f = R/2 = + \frac{3.00 \text{ m}}{2} = + 1.50$ m (as the principal focus of a convex mirror is behind the mirror)

$$\text{Since } \frac{1}{v} + \frac{1}{u} = \frac{1}{f}$$

$$\text{or, } \frac{1}{v} + \frac{1}{u} = \frac{1}{f} = + \frac{1}{1.50} - \frac{1}{(-5.00)} = \frac{1}{1.50} + \frac{1}{5.00}$$
$$= \frac{5.00 + 1.50}{7.50}$$

$$v = \frac{+7.50}{6.50} = +1.15 \text{ m}$$

The image is 1.15 m at the back of the mirror.

$$\text{Magnification, } m = \frac{h'}{h} = - \frac{h'}{h} = - \frac{1.15 \text{ m}}{-5.00 \text{ m}}$$
$$= + 0.23$$

The image is virtual, erect and smaller in size by a factor of 0.23.

Example 10.2

An object, 4.0 cm in size, is placed at 25.0 cm in front of a concave mirror of focal length 15.0 cm. At what distance from the mirror should a screen be placed in order to obtain a sharp image? Find the nature and the size of the image.

Solution

Object-size, $h = + 4.0$ cm;

Object-distance, $u = - 25.0$ cm;

Focal length, $f = - 15.0$ cm;

Image-distance, $v = ?$

Image-size, $h' = ?$

From Eq. (10.1):

$$\text{Since } \frac{1}{v} + \frac{1}{u} = \frac{1}{f}$$

$$\text{or, } \frac{1}{v} + \frac{1}{f} = \frac{1}{u} = \frac{1}{-15.0} - \frac{1}{-25.0} = - \frac{1}{15.0} + \frac{1}{25.0}$$

$$\text{or, } \frac{1}{v} = \frac{-5.0 + 3.0}{75.0} = \frac{-2.0}{75.0} \text{ or, } v = -37.5 \text{ cm}$$

The screen should be placed at 37.5 cm in front of the mirror. The image is real.

$$\text{Also, magnification, } m = \frac{h'}{h} = -\frac{v}{u}$$

$$\text{or, } h' = -\frac{vh}{u} = -\frac{(-37.5 \text{ cm})(+4.0 \text{ cm})}{(-25.0 \text{ cm})}$$

Height of the image, $h' = -6.0 \text{ cm}$
The image is inverted and enlarged.

Q U E S T I O N S

1. Find the focal length of a convex mirror whose radius of curvature is 32 cm.
2. A concave mirror produces three times magnified (enlarged) real image of an object placed at 10 cm in front of it. Where is the image located?

10.3 REFRACTION OF LIGHT

Light seems to travel along straight-line paths in a transparent medium. What happens when light enters from one transparent medium to another? Does it still move along a straight-line path or change its direction? We shall recall some of our day-to-day experiences.

You might have observed that the bottom of a tank or a pond containing water appears to be raised. Similarly, when a thick glass slab is placed over some printed matter, the letters appear raised when viewed through the glass slab. Why does it happen? Have you seen a pencil partly immersed in water in a glass tumbler? It appears to be displaced at the interface of air and water. You might have observed that a lemon kept in water in a glass tumbler appears to be bigger than its actual size, when viewed from the sides. How can you account for such experiences?

Let us consider the case of the apparent displacement of a pencil, partly immersed in water. The light reaching you from the portion of the pencil inside water seems to come from a different direction, compared to the part above water. This makes the pencil appear to be displaced at the interface. For similar reasons, the letters appear to be raised, when seen through a glass slab placed over it.

Does a pencil appear to be displaced to the same extent, if instead of water, we use liquids like kerosene or turpentine? Will the letters appear to rise to the same height if we replace a glass slab with a transparent plastic slab? You will find that the extent of the effect is different for different pair of media. These observations indicate that light does not

travel in the same direction in all media. It appears that when travelling obliquely from one medium to another, the direction of propagation of light in the second medium changes. This phenomenon is known as refraction of light. Let us understand this phenomenon further by doing a few activities.

Activity 10.7

- Place a coin at the bottom of a bucket filled with water.
- With your eye to a side above water, try to pick up the coin in one go. Did you succeed in picking up the coin?
- Repeat the Activity. Why did you not succeed in doing it in one go?
- Ask your friends to do this. Compare your experience with theirs.

Activity 10.8

- Place a large shallow bowl on a Table and put a coin in it.
- Move away slowly from the bowl. Stop when the coin just disappears from your sight.
- Ask a friend to pour water gently into the bowl without disturbing the coin.
- Keep looking for the coin from your position. Does the coin becomes visible again from your position? How could this happen?

The coin becomes visible again on pouring water into the bowl. The coin appears slightly raised above its actual position due to refraction of light.

Activity 10.9

- Draw a thick straight line in ink, over a sheet of white paper placed on a Table.
- Place a glass slab over the line in such a way that one of its edges makes an angle with the line.
- Look at the portion of the line under the slab from the sides. What do you observe? Does the line under the glass slab appear to be bent at the edges?
- Next, place the glass slab such that it is normal to the line. What do you observe now? Does the part of the line under the glass slab appear bent?
- Look at the line from the top of the glass slab. Does the part of the line, beneath the slab, appear to be raised? Why does this happen?

10.3.1 Refraction through a Rectangular Glass Slab

To understand the phenomenon of refraction of light through a glass slab, let us do an Activity.

Activity 10.10

- Fix a sheet of white paper on a drawing board using drawing pins.
- Place a rectangular glass slab over the sheet in the middle.
- Draw the outline of the slab with a pencil. Let us name the outline as ABCD.
- Take four identical pins.
- Fix two pins, say E and F, vertically such that the line joining the pins is inclined to the edge AB.
- Look for the images of the pins E and F through the opposite edge. Fix two other pins, say G and H, such that these pins and the images of E and F lie on a straight line.
- Remove the pins and the slab.
- Join the positions of tip of the pins E and F and produce the line up to AB. Let EF meet AB at O. Similarly, join the positions of tip of the pins G and H and produce it up to the edge CD. Let HG meet CD at O'.
- Join O and O'. Also produce EF up to P, as shown by a dotted line in Fig. 10.10.

In this Activity, you will note, the light ray has changed its direction at points O and O'. Note that both the points O and O' lie on surfaces separating two transparent media. Draw a perpendicular NN' to AB at O and another perpendicular MM' to CD at O'. The light ray at point O has entered from a rarer medium to a denser medium, that is, from air to glass. Note that the light ray has bent towards the normal. At O', the light ray has entered from a denser medium to a rarer medium, that is, from a denser medium to a rarer medium. The light here has bent away from the normal. Compare the angle of incidence with the angle of refraction at both refracting surfaces AB and CD.

In Fig. 10.10, a ray EO is obliquely incident on surface AB, called incident ray. OO' is the refracted ray and O'H is the emergent ray. You may observe that the emergent ray is parallel to the direction of the incident ray. Why does it happen so? The extent of bending of the ray of light at the opposite parallel faces AB (air-glass interface) and CD (glass-air interface) of the rectangular glass slab is equal and opposite. This is why the ray emerges parallel to the incident ray. However, the light ray is shifted sideward slightly. What happens when a light ray is incident normally to the interface of two media? Try and find out.

Now you are familiar with the refraction of light. Refraction is due to change in the speed of light as it enters from one transparent medium to another. Experiments show that refraction of light occurs according to certain laws.

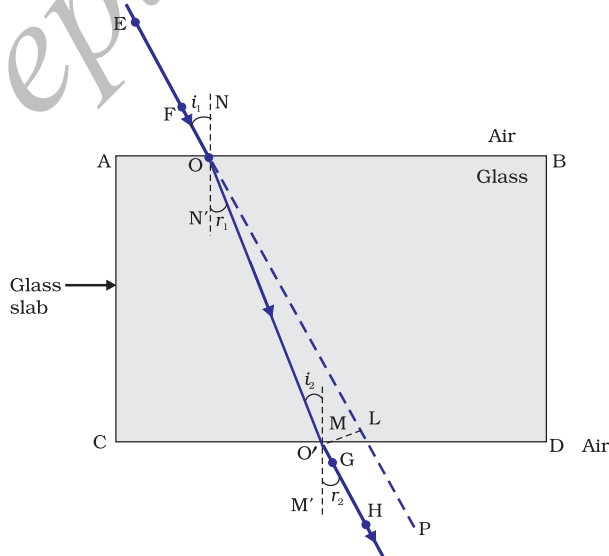

Figure 10.10
Refraction of light through a rectangular glass slab

The following are the laws of refraction of light.

- (i) The incident ray, the refracted ray and the normal to the interface of two transparent media at the point of incidence, all lie in the same plane.
- (ii) The ratio of sine of angle of incidence to the sine of angle of refraction is a constant, for the light of a given colour and for the given pair of media. This law is also known as Snell's law of refraction. (This is true for angle $0 < i < 90^\circ$)

If i is the angle of incidence and r is the angle of refraction, then,

$$\frac{\sin i}{\sin r} = \text{constant} \quad (10.4)$$

This constant value is called the refractive index of the second medium with respect to the first. Let us study about refractive index in some detail.

10.3.2 The Refractive Index

You have already studied that a ray of light that travels obliquely from one transparent medium into another will change its direction in the second medium. The extent of the change in direction that takes place in a given pair of media may be expressed in terms of the refractive index, the "constant" appearing on the right-hand side of Eq.(10.4).

The refractive index can be linked to an important physical quantity, the relative speed of propagation of light in different media. It turns out that light propagates with different speeds in different media. Light travels fastest in vacuum with speed of $3 \times 10^8 \text{ m s}^{-1}$. In air, the speed of light is only marginally less, compared to that in vacuum. It reduces considerably in glass or water. The value of the refractive index for a given pair of media depends upon the speed of light in the two media, as given below.

Consider a ray of light travelling from medium 1 into medium 2, as shown in Fig.10.11. Let v_1 be the speed of light in medium 1 and v_2 be the speed of light in medium 2. The refractive index of medium 2 with respect to medium 1 is given by the ratio of the speed of light in medium 1 and the speed of light in medium 2. This is usually represented by the symbol n_{21} . This can be expressed in an equation form as

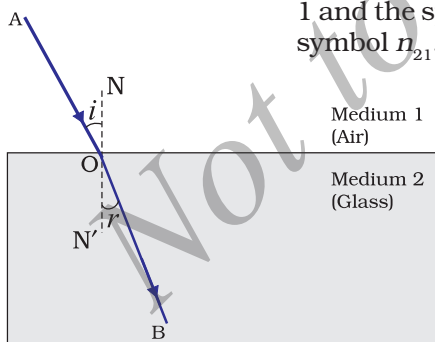

Figure 10.11

$$n_{21} = \frac{\text{Speed of light in medium 1}}{\text{Speed of light in medium 2}} = \frac{v_1}{v_2} \quad (10.5)$$

By the same argument, the refractive index of medium 1 with respect to medium 2 is represented as n_{12} . It is given by

$$n_{12} = \frac{\text{Speed of light in medium 2}}{\text{Speed of light in medium 1}} = \frac{v_2}{v_1} \quad (10.6)$$

If medium 1 is vacuum or air, then the refractive index of medium 2 is considered with respect to vacuum. This is called the absolute refractive index of the medium. It is simply represented as n_2 . If c is the speed of

light in air and v is the speed of light in the medium, then, the refractive index of the medium n_m is given by

$$n_m = \frac{\text{Speed of light in air}}{\text{Speed of light in the medium}} = \frac{c}{v} \quad (10.7)$$

The absolute refractive index of a medium is simply called its refractive index. The refractive index of several media is given in Table 10.3. From the Table you can know that the refractive index of water, $n_w = 1.33$. This means that the ratio of the speed of light in air and the speed of light in water is equal to 1.33. Similarly, the refractive index of crown glass, $n_g = 1.52$. Such data are helpful in many places. However, you need not memorise the data.

Table 10.3 Absolute refractive index of some material media

Material medium	Refractive index	Material medium	Refractive index
Air	1.0003	Canada Balsam	1.53
Ice	1.31	Rock salt	1.54
Water	1.33	Carbon disulphide	1.63
Alcohol	1.36	Dense flint glass	1.65
Kerosene	1.44	Ruby	1.71
Fused quartz	1.46	Sapphire	1.77
Turpentine oil	1.47	Diamond	2.42
Benzene	1.50		
Crown glass	1.52		

Note from Table 10.3 that an optically denser medium may not possess greater mass density. For example, kerosene having higher refractive index, is optically denser than water, although its mass density is less than water.

More to Know!

The ability of a medium to refract light is also expressed in terms of its optical density. Optical density has a definite connotation. It is not the same as mass density. We have been using the terms 'rarer medium' and 'denser medium' in this Chapter. It actually means 'optically rarer medium' and 'optically denser medium', respectively. When can we say that a medium is optically denser than the other? In comparing two media, the one with the larger refractive index is optically denser medium than the other. The other medium of lower refractive index is optically rarer. The speed of light is higher in a rarer medium than a denser medium. Thus, a ray of light travelling from a rarer medium to a denser medium slows down and bends towards the normal. When it travels from a denser medium to a rarer medium, it speeds up and bends away from the normal.

Q U E S T I O N S

1. A ray of light travelling in air enters obliquely into water. Does the light ray bend towards the normal or away from the normal? Why?
2. Light enters from air to glass having refractive index 1.50. What is the speed of light in the glass? The speed of light in vacuum is $3 \times 10^8 \text{ m s}^{-1}$.
3. Find out, from Table 10.3, the medium having highest optical density. Also find the medium with lowest optical density.
4. You are given kerosene, turpentine and water. In which of these does the light travel fastest? Use the information given in Table 10.3.
5. The refractive index of diamond is 2.42. What is the meaning of this statement?

10.3.3 Refraction by Spherical Lenses

You might have seen watchmakers using a small magnifying glass to see tiny parts. Have you ever touched the surface of a magnifying glass with your hand? Is it plane surface or curved? Is it thicker in the middle or at the edges? The glasses used in spectacles and that by a watchmaker are examples of lenses. What is a lens? How does it bend light rays? We shall discuss these in this section.

A transparent material bound by two surfaces, of which one or both surfaces are spherical, forms a lens. This means that a lens is bound by at least one spherical surface. In such lenses, the other surface would be plane. A lens may have two spherical surfaces, bulging outwards. Such a lens is called a double convex lens. It is simply called a convex lens. It is thicker at the middle as compared to the edges. Convex lens converges light rays as shown in Fig. 10.12 (a). Hence convex lenses are also called converging lenses. Similarly, a double concave lens is bounded by two spherical surfaces, curved inwards. It is thicker at the edges than at the middle. Such lenses diverge light rays as shown in Fig. 10.12 (b). Such lenses are also called diverging lenses. A double concave lens is simply called a concave lens.

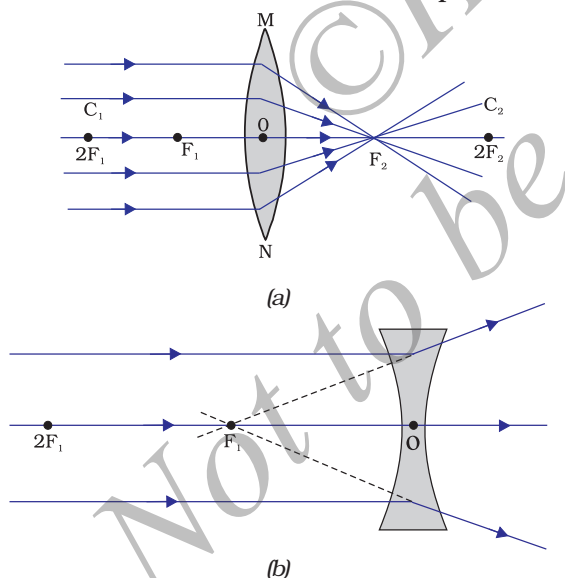

Figure 10.12

(a) Converging action of a convex lens, (b) diverging action of a concave lens

A lens, either a convex lens or a concave lens, has two spherical surfaces. Each of these surfaces forms a part of a sphere. The centres of these spheres are called centres of curvature of the lens. The centre of curvature of a lens is usually represented by the letter C. Since there are two centres of curvature, we may represent them as C_1 and C_2 . An imaginary straight line passing through the two centres of curvature of a lens is called its principal axis. The central point of a lens is its optical centre. It is

usually represented by the letter O. A ray of light through the optical centre of a lens passes without suffering any deviation. The effective diameter of the circular outline of a spherical lens is called its aperture. We shall confine our discussion in this Chapter to such lenses whose aperture is much less than its radius of curvature and the two centres of curvatures are equidistant from the optical centre O. Such lenses are called thin lenses with small apertures. What happens when parallel rays of light are incident on a lens? Let us do an Activity to understand this.

Activity 10.11

CAUTION: Do not look at the Sun directly or through a lens while doing this Activity or otherwise. You may damage your eyes if you do so.

- Hold a convex lens in your hand. Direct it towards the Sun.
- Focus the light from the Sun on a sheet of paper. Obtain a sharp bright image of the Sun.
- Hold the paper and the lens in the same position for a while. Keep observing the paper. What happened? Why? Recall your experience in Activity 10.2.

The paper begins to burn producing smoke. It may even catch fire after a while. Why does this happen? The light from the Sun constitutes parallel rays of light. These rays were converged by the lens at the sharp bright spot formed on the paper. In fact, the bright spot you got on the paper is a real image of the Sun. The concentration of the sunlight at a point generated heat. This caused the paper to burn.

Now, we shall consider rays of light parallel to the principal axis of a lens. What happens when you pass such rays of light through a lens? This is illustrated for a convex lens in Fig.10.12 (a) and for a concave lens in Fig.10.12 (b).

Observe Fig.10.12 (a) carefully. Several rays of light parallel to the principal axis are falling on a convex lens. These rays, after refraction from the lens, are converging to a point on the principal axis. This point on the principal axis is called the principal focus of the lens. Let us see now the action of a concave lens.

Observe Fig.10.12 (b) carefully. Several rays of light parallel to the principal axis are falling on a concave lens. These rays, after refraction from the lens, are appearing to diverge from a point on the principal axis. This point on the principal axis is called the principal focus of the concave lens.

If you pass parallel rays from the opposite surface of the lens, you get another principal focus on the opposite side. Letter F is usually used to represent principal focus. However, a lens has two principal foci. They are represented by F_1 and F_2 . The distance of the principal focus from the optical centre of a lens is called its focal length. The letter f is used to represent the focal length. How can you find the focal length of a convex lens? Recall the Activity 10.11. In this Activity, the distance between the position of the lens and the position of the image of the Sun gives the approximate focal length of the lens.

10.3.4 Image Formation by Lenses

Lenses form images by refracting light. How do lenses form images? What is their nature? Let us study this for a convex lens first.

Activity 10.12

- Take a convex lens. Find its approximate focal length in a way described in Activity 10.11.
- Draw five parallel straight lines, using chalk, on a long Table such that the distance between the successive lines is equal to the focal length of the lens.
- Place the lens on a lens stand. Place it on the central line such that the optical centre of the lens lies just over the line.
- The two lines on either side of the lens correspond to F and $2F$ of the lens respectively. Mark them with appropriate letters such as $2F_1$, F_1 , F_2 and $2F_2$, respectively.
- Place a burning candle, far beyond $2F_1$ to the left. Obtain a clear sharp image on a screen on the opposite side of the lens.
- Note down the nature, position and relative size of the image.
- Repeat this Activity by placing object just behind $2F_1$, between F_1 and $2F_1$ at F_1 , between F_1 and O . Note down and tabulate your observations.

The nature, position and relative size of the image formed by convex lens for various positions of the object is summarised in Table 10.4.

Table 10.4 Nature, position and relative size of the image formed by a convex lens for various positions of the object

Position of the object	Position of the image	Relative size of the image	Nature of the image
At infinity	At focus F_2	Highly diminished, point-sized	Real and inverted
Beyond $2F_1$	Between F_2 and $2F_2$	Diminished	Real and inverted
At $2F_1$	At $2F_2$	Same size	Real and inverted
Between F_1 and $2F_1$	Beyond $2F_2$	Enlarged	Real and inverted
At focus F_1	At infinity	Infinitely large or highly enlarged	Real and inverted
Between focus F_1 and optical centre O	On the same side of the lens as the object	Enlarged	Virtual and erect

Let us now do an Activity to study the nature, position and relative size of the image formed by a concave lens.

Activity 10.13

- Take a concave lens. Place it on a lens stand.
- Place a burning candle on one side of the lens.
- Look through the lens from the other side and observe the image. Try to get the image on a screen, if possible. If not, observe the image directly through the lens.
- Note down the nature, relative size and approximate position of the image.
- Move the candle away from the lens. Note the change in the size of the image. What happens to the size of the image when the candle is placed too far away from the lens.

The summary of the above Activity is given in Table 10.5 below.

Table 10.5 Nature, position and relative size of the image formed by a concave lens for various positions of the object

Position of the object	Position of the image	Relative size of the image	Nature of the image
At infinity	At focus F_1	Highly diminished, point-sized	Virtual and erect
Between infinity and optical centre O of the lens	Between focus F_1 and optical centre O	Diminished	Virtual and erect

What conclusion can you draw from this Activity? A concave lens will always give a virtual, erect and diminished image, irrespective of the position of the object.

10.3.5 Image Formation in Lenses Using Ray Diagrams

We can represent image formation by lenses using ray diagrams. Ray diagrams will also help us to study the nature, position and relative size of the image formed by lenses. For drawing ray diagrams in lenses, alike of spherical mirrors, we consider any two of the following rays –

- (i) A ray of light from the object, parallel to the principal axis, after refraction from a convex lens, passes through the principal focus on the other side of the lens, as shown in Fig. 10.13 (a). In case of a concave lens, the ray appears to diverge from the principal focus located on the same side of the lens, as shown in Fig. 10.13 (b).

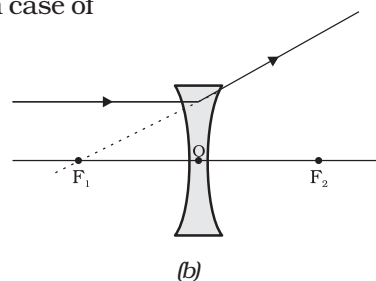
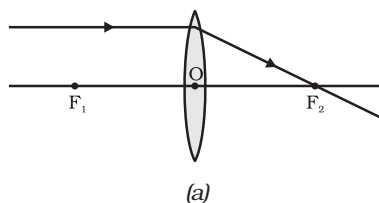

Figure 10.13

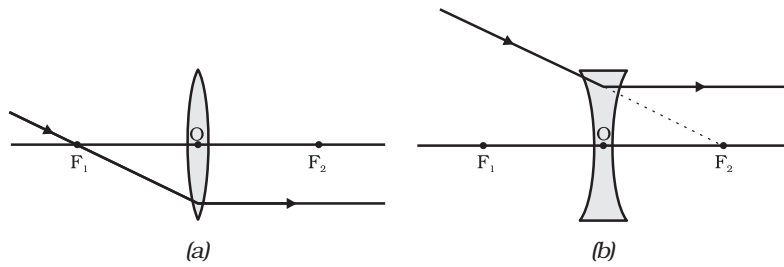

Figure 10.14

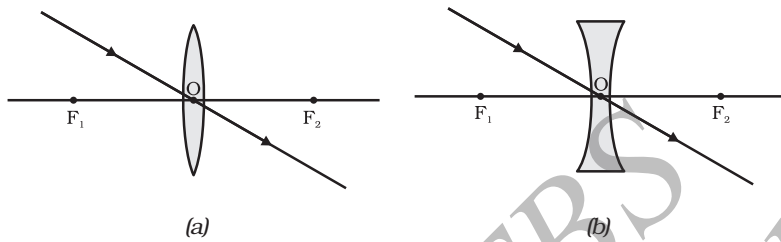
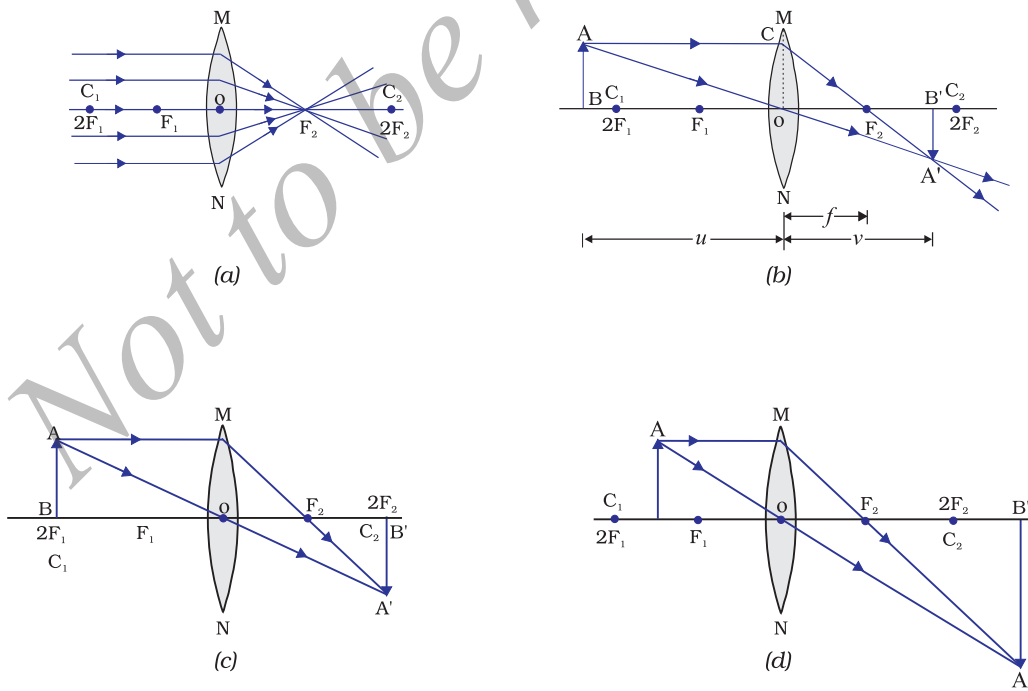

Figure 10.15

- (ii) A ray of light passing through a principal focus, after refraction from a convex lens, will emerge parallel to the principal axis. This is shown in Fig. 10.14 (a). A ray of light appearing to meet at the principal focus of a concave lens, after refraction, will emerge parallel to the principal axis. This is shown in Fig. 10.14 (b).
- (iii) A ray of light passing through the optical centre of a lens will emerge without any deviation. This is illustrated in Fig. 10.15 (a) and Fig. 10.15 (b).

The ray diagrams for the image formation in a convex lens for a few positions of the object are shown in Fig. 10.16. The ray diagrams representing the image formation in a concave lens for various positions of the object are shown in Fig. 10.17.



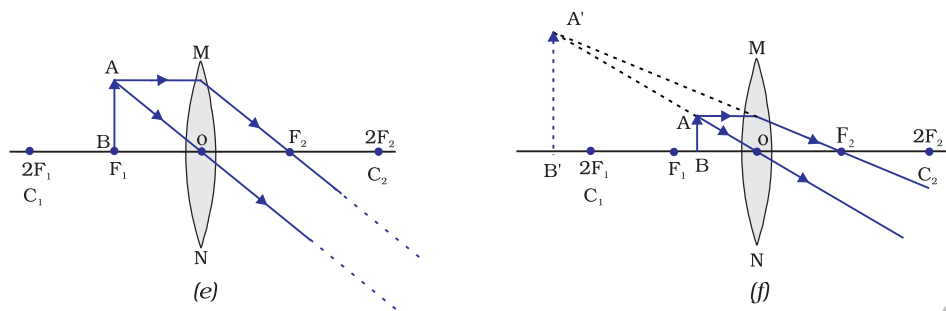

Figure 10.16 The position, size and the nature of the image formed by a convex lens for various positions of the object

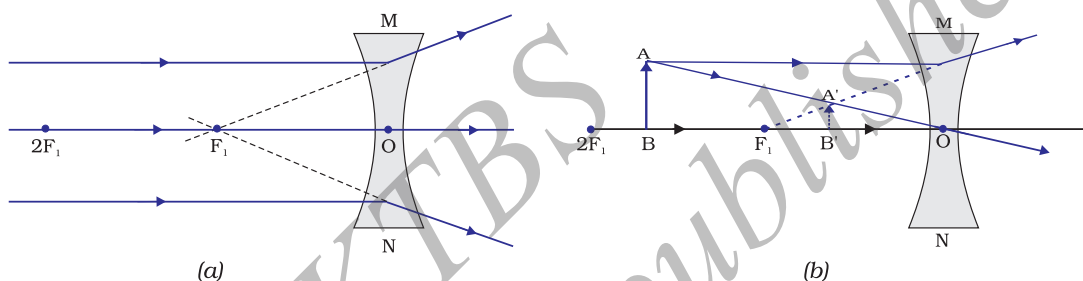

Figure 10.17 Nature, position and relative size of the image formed by a concave lens

10.3.6 Sign Convention for Spherical Lenses

For lenses, we follow sign convention, similar to the one used for spherical mirrors. We apply the rules for signs of distances, except that all measurements are taken from the optical centre of the lens. According to the convention, the focal length of a convex lens is positive and that of a concave lens is negative. You must take care to apply appropriate signs for the values of u , v , f , object height h and image height h' .

10.3.7 Lens Formula and Magnification

As we have a formula for spherical mirrors, we also have formula for spherical lenses. This formula gives the relationship between object-distance (u), image-distance (v) and the focal length (f). The lens formula is expressed as

$$\frac{1}{v} - \frac{1}{u} = \frac{1}{f} \quad (10.8)$$

The lens formula given above is general and is valid in all situations for any spherical lens. Take proper care of the signs of different quantities, while putting numerical values for solving problems relating to lenses.

Magnification

The magnification produced by a lens, similar to that for spherical mirrors, is defined as the ratio of the height of the image and the height of the object. Magnification is represented by the letter m . If h is the height of the object and h' is the height of the image given by a lens, then the magnification produced by the lens is given by,

$$m = \frac{\text{Height of the Image}}{\text{Height of the object}} = \frac{h'}{h} \quad (10.9)$$

Magnification produced by a lens is also related to the object-distance u , and the image-distance v . This relationship is given by

$$\text{Magnification } (m) = h'/h = v/u \quad (10.10)$$

Example 10.3

A concave lens has focal length of 15 cm. At what distance should the object from the lens be placed so that it forms an image at 10 cm from the lens? Also, find the magnification produced by the lens.

Solution

A concave lens always forms a virtual, erect image on the same side of the object.

Image-distance v = -10 cm;

Focal length f = -15 cm;

Object-distance u = ?

$$\text{Since } \frac{1}{v} - \frac{1}{u} = \frac{1}{f}$$

$$\text{or, } \frac{1}{u} = \frac{1}{v} - \frac{1}{f}$$

$$\frac{1}{u} = \frac{1}{-10} - \frac{1}{(-15)} = -\frac{1}{10} + \frac{1}{15}$$

$$\frac{1}{u} = \frac{-3 + 2}{30} = \frac{1}{-30}$$

or, $u = -30$ cm

Thus, the object-distance is 30 cm.

Magnification $m = v/u$

$$m = \frac{-10 \text{ cm}}{-20 \text{ cm}} = \frac{1}{3} = +0.33$$

The positive sign shows that the image is erect and virtual. The image is one-third of the size of the object.

Example 10.4

A 2.0 cm tall object is placed perpendicular to the principal axis of a convex lens of focal length 10 cm. The distance of the object from the lens is 15 cm. Find the nature, position and size of the image. Also find its magnification.

Solution

Height of the object $h = +2.0$ cm;
Focal length $f = +10$ cm;
object-distance $u = -15$ cm;
Image-distance $v = ?$
Height of the image $h' = ?$

$$\text{Since } \frac{1}{v} - \frac{1}{u} = \frac{1}{f}$$

$$\text{or, } \frac{1}{v} = \frac{1}{u} + \frac{1}{f}$$

$$\frac{1}{v} = \frac{1}{(-15)} + \frac{1}{10} = -\frac{1}{15} + \frac{1}{10}$$

$$\frac{1}{v} = \frac{-2 + 3}{30} = \frac{1}{30}$$

$$\text{or, } v = +30 \text{ cm}$$

The positive sign of v shows that the image is formed at a distance of 30 cm on the other side of the optical centre. The image is real and inverted.

$$\text{Magnification } m = \frac{h'}{h} = \frac{v}{u}$$

$$\text{or, } h' = h (v/u)$$

$$\text{Height of the image, } h' = (2.0) (+30/-15) = -4.0 \text{ cm}$$

$$\text{Magnification } m = v/u$$

$$\text{or, } m = -\frac{+30 \text{ cm}}{-15 \text{ cm}} = -2$$

The negative signs of m and h' show that the image is inverted and real. It is formed below the principal axis. Thus, a real, inverted image, 4 cm tall, is formed at a distance of 30 cm on the other side of the lens. The image is two times enlarged.

10.3.8 Power of a Lens

You have already learnt that the ability of a lens to converge or diverge light rays depends on its focal length. For example, a convex lens of short focal length bends the light rays through large angles, by focussing them closer to the optical centre. Similarly, concave lens of very short focal length causes higher divergence than the one with longer focal length. The degree of convergence or divergence of light rays achieved by a lens is expressed in terms of its power. The power of a lens is defined as the reciprocal of its focal length. It is represented by the letter P . The power P of a lens of focal length f is given by

$$P = \frac{1}{f} \quad (10.11)$$

The SI unit of power of a lens is 'diopetre'. It is denoted by the letter D. If f is expressed in metres, then, power is expressed in dioptries. Thus, 1 diopetre is the power of a lens whose focal length is 1 metre. $1D = 1\text{m}^{-1}$. You may note that the *power of a convex lens is positive and that of a concave lens is negative*.

Opticians prescribe corrective lenses indicating their powers. Let us say the lens prescribed has power equal to + 2.0 D. This means the lens prescribed is convex. The focal length of the lens is + 0.50 m. Similarly, a lens of power – 2.5 D has a focal length of – 0.40 m. The lens is concave.

More to Know!

Many optical instruments consist of a number of lenses. They are combined to increase the magnification and sharpness of the image. The net power (P) of the lenses placed in contact is given by the algebraic sum of the individual powers P_1, P_2, P_3, \dots as $P = P_1 + P_2 + P_3 + \dots$

The use of powers, instead of focal lengths, for lenses is quite convenient for opticians. During eye-testing, an optician puts several different combinations of corrective lenses of known power, in contact, inside the testing spectacles' frame. The optician calculates the power of the lens required by simple algebraic addition. For example, a combination of two lenses of power + 2.0 D and + 0.25 D is equivalent to a single lens of power + 2.25 D. The simple additive property of the powers of lenses can be used to design lens systems to minimise certain defects in images produced by a single lens. Such a lens system, consisting of several lenses, in contact, is commonly used in the design of lenses of camera, microscopes and telescopes.

QUESTIONS

1. Define 1 diopetre of power of a lens.
2. A convex lens forms a real and inverted image of a needle at a distance of 50 cm from it. Where is the needle placed in front of the convex lens if the image is equal to the size of the object? Also, find the power of the lens.
3. Find the power of a concave lens of focal length 2 m.

What you have learnt

- Light seems to travel in straight lines.
- Mirrors and lenses form images of objects. Images can be either real or virtual, depending on the position of the object.
- The reflecting surfaces, of all types, obey the laws of reflection. The refracting surfaces obey the laws of refraction.
- New Cartesian Sign Conventions are followed for spherical mirrors and lenses.

- Mirror formula, $\frac{1}{v} + \frac{1}{u} = \frac{1}{f}$, gives the relationship between the object-distance (u), image-distance (v), and focal length (f) of a spherical mirror.
- The focal length of a spherical mirror is equal to half its radius of curvature.
- The magnification produced by a spherical mirror is the ratio of the height of the image to the height of the object.
- A light ray travelling obliquely from a denser medium to a rarer medium bends away from the normal. A light ray bends towards the normal when it travels obliquely from a rarer to a denser medium.
- Light travels in vacuum with an enormous speed of $3 \times 10^8 \text{ m s}^{-1}$. The speed of light is different in different media.
- The refractive index of a transparent medium is the ratio of the speed of light in vacuum to that in the medium.
- In case of a rectangular glass slab, the refraction takes place at both air-glass interface and glass-air interface. The emergent ray is parallel to the direction of incident ray.
- Lens formula, $\frac{1}{v} - \frac{1}{u} = \frac{1}{f}$, gives the relationship between the object-distance (u), image-distance (v), and the focal length (f) of a spherical lens.
- Power of a lens is the reciprocal of its focal length. The SI unit of power of a lens is *dioptr*.

E X E R C I S E S

1. Which one of the following materials cannot be used to make a lens?
 (a) Water (b) Glass (c) Plastic (d) Clay
2. The image formed by a concave mirror is observed to be virtual, erect and larger than the object. Where should be the position of the object?
 (a) Between the principal focus and the centre of curvature
 (b) At the centre of curvature
 (c) Beyond the centre of curvature
 (d) Between the pole of the mirror and its principal focus.
3. Where should an object be placed in front of a convex lens to get a real image of the size of the object?
 (a) At the principal focus of the lens
 (b) At twice the focal length
 (c) At infinity
 (d) Between the optical centre of the lens and its principal focus.
4. A spherical mirror and a thin spherical lens have each a focal length of -15 cm . The mirror and the lens are likely to be
 (a) both concave.
 (b) both convex.

- (c) the mirror is concave and the lens is convex.
(d) the mirror is convex, but the lens is concave.
5. No matter how far you stand from a mirror, your image appears erect. The mirror is likely to be
- (a) only plane.
(b) only concave.
(c) only convex.
(d) either plane or convex.
6. Which of the following lenses would you prefer to use while reading small letters found in a dictionary?
- (a) A convex lens of focal length 50 cm.
(b) A concave lens of focal length 50 cm.
(c) A convex lens of focal length 5 cm.
(d) A concave lens of focal length 5 cm.
7. We wish to obtain an erect image of an object, using a concave mirror of focal length 15 cm. What should be the range of distance of the object from the mirror? What is the nature of the image? Is the image larger or smaller than the object? Draw a ray diagram to show the image formation in this case.
8. Name the type of mirror used in the following situations.
- (a) Headlights of a car.
(b) Side/rear-view mirror of a vehicle.
(c) Solar furnace.
Support your answer with reason.
9. One-half of a convex lens is covered with a black paper. Will this lens produce a complete image of the object? Verify your answer experimentally. Explain your observations.
10. An object 5 cm in length is held 25 cm away from a converging lens of focal length 10 cm. Draw the ray diagram and find the position, size and the nature of the image formed.
11. A concave lens of focal length 15 cm forms an image 10 cm from the lens. How far is the object placed from the lens? Draw the ray diagram.
12. An object is placed at a distance of 10 cm from a convex mirror of focal length 15 cm. Find the position and nature of the image.
13. The magnification produced by a plane mirror is +1. What does this mean?
14. An object 5.0 cm in length is placed at a distance of 20 cm in front of a convex mirror of radius of curvature 30 cm. Find the position of the image, its nature and size.
15. An object of size 7.0 cm is placed at 27 cm in front of a concave mirror of focal length 18 cm. At what distance from the mirror should a screen be placed, so that a sharp focussed image can be obtained? Find the size and the nature of the image.
16. Find the focal length of a lens of power -2.0 D. What type of lens is this?
17. A doctor has prescribed a corrective lens of power $+1.5$ D. Find the focal length of the lens. Is the prescribed lens diverging or converging?

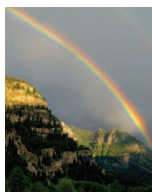

CHAPTER 11

The Human Eye and the Colourful World



You have studied in the previous chapter about refraction of light by lenses. You also studied the nature, position and relative size of images formed by lenses. How can these ideas help us in the study of the human eye? The human eye uses light and enables us to see objects around us. It has a lens in its structure. What is the function of the lens in a human eye? How do the lenses used in spectacles correct defects of vision? Let us consider these questions in this chapter.

We have learnt in the previous chapter about light and some of its properties. In this chapter, we shall use these ideas to study some of the optical phenomena in nature. We shall also discuss about rainbow formation, splitting of white light and blue colour of the sky.

11.1 THE HUMAN EYE

The human eye is one of the most valuable and sensitive sense organs. It enables us to see the wonderful world and the colours around us. On closing the eyes, we can identify objects to some extent by their smell, taste, sound they make or by touch. It is, however, impossible to identify colours while closing the eyes. Thus, of all the sense organs, the human eye is the most significant one as it enables us to see the beautiful, colourful world around us.

The human eye is like a camera. Its lens system forms an image on a light-sensitive screen called the retina. Light enters the eye through a thin membrane called the cornea. It forms the transparent bulge on the front surface of the eyeball as shown in Fig. 11.1. The eyeball is approximately spherical in shape with a diameter of about 2.3 cm. Most of the refraction for the light rays entering the eye occurs at the outer surface of the cornea. The crystalline lens merely provides the finer adjustment of focal length required to focus objects at different distances on the retina. We find a structure called *iris* behind the cornea. Iris is a dark muscular diaphragm that controls the size of the pupil. The pupil regulates and controls the amount of light

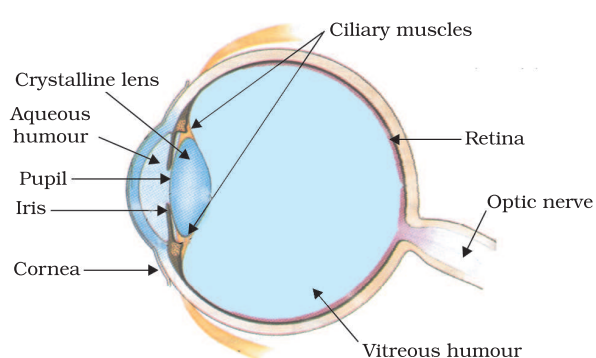

Figure 11.1
The human eye

entering the eye. The eye lens forms an inverted real image of the object on the retina. The retina is a delicate membrane having enormous number of light-sensitive cells. The light-sensitive cells get activated upon illumination and generate electrical signals. These signals are sent to the brain via the optic nerves. The brain interprets these signals, and finally, processes the information so that we perceive objects as they are.

Do You Know?

Damage to or malfunction of any part of the visual system can lead to significant loss of visual functioning. For example, if any of the structures involved in the transmission of light, like the cornea, pupil, eye lens, aqueous humour and vitreous humour or those responsible for conversion of light to electrical impulse, like the retina or even the optic nerve that transmits these impulses to the brain, is damaged, it will result in visual impairment. You might have experienced that you are not able to see objects clearly for some time when you enter from bright light to a room with dim light. After sometime, however, you may be able to see things in the dim-lit room. The pupil of an eye acts like a variable aperture whose size can be varied with the help of the iris. When the light is very bright, the iris contracts the pupil to allow less light to enter the eye. However, in dim light the iris expands the pupil to allow more light to enter the eye. Thus, the pupil opens completely through the relaxation of the iris.

11.1.1 Power of Accommodation

The eye lens is composed of a fibrous, jelly-like material. Its curvature can be modified to some extent by the ciliary muscles. The change in the curvature of the eye lens can thus change its focal length. When the muscles are relaxed, the lens becomes thin. Thus, its focal length increases. This enables us to see distant objects clearly. When you are looking at objects closer to the eye, the ciliary muscles contract. This increases the curvature of the eye lens. The eye lens then becomes thicker. Consequently, the focal length of the eye lens decreases. This enables us to see nearby objects clearly.

The ability of the eye lens to adjust its focal length is called accommodation. However, the focal length of the eye lens cannot be decreased below a certain minimum limit. Try to read a printed page by holding it very close to your eyes. You may see the image being blurred or feel strain in the eye. To see an object comfortably and distinctly, you must hold it at about 25 cm from the eyes. The minimum distance, at which objects can be seen most distinctly without strain, is called the least distance of distinct vision. It is also called the near point of the eye. For a young adult with normal vision, the near point is about 25 cm. The farthest point upto which the eye can see objects clearly is called the far point of the eye. It is infinity for a normal eye. You may note here a normal eye can see objects clearly that are between 25 cm and infinity.

Sometimes, the crystalline lens of people at old age becomes milky and cloudy. This condition is called cataract. This causes partial or complete loss of vision. It is possible to restore vision through a cataract surgery.

Why do we have two eyes for vision and not just one?

There are several advantages of our having two eyes instead of one. It gives a wider field of view. A human being has a horizontal field of view of about 150° with one eye and of about 180° with two eyes. The ability to detect faint objects is, of course, enhanced with two detectors instead of one.

Some animals, usually prey animals, have their two eyes positioned on opposite sides of their heads to give the widest possible field of view. But our two eyes are positioned on the front of our heads, and it thus reduces our field of view in favour of what is called stereopsis. Shut one eye and the world looks flat – two-dimensional. Keep both eyes open and the world takes on the third dimension of depth. Because our eyes are separated by a few centimetres, each eye sees a slightly different image. Our brain combines the two images into one, using the extra information to tell us how close or far away things are.

11.2 DEFECTS OF VISION AND THEIR CORRECTION

Sometimes, the eye may gradually lose its power of accommodation. In such conditions, the person cannot see the objects distinctly and comfortably. The vision becomes blurred due to the refractive defects of the eye.

There are mainly three common refractive defects of vision. These are (i) myopia or near-sightedness, (ii) Hypermetropia or far-sightedness, and (iii) Presbyopia. These defects can be corrected by the use of suitable spherical lenses. We discuss below these defects and their correction.

(a) Myopia

Myopia is also known as near-sightedness. A person with myopia can see nearby objects clearly but cannot see distant objects distinctly. A person with this defect has the far point nearer than infinity. Such a person may see clearly upto a distance of a few metres. In a myopic eye, the image of a distant object is formed in front of the retina [Fig. 11.2 (b)] and not at the retina itself. This defect may arise due to (i) excessive curvature of the eye lens, or (ii) elongation of the eyeball. This defect can be corrected by using a concave lens of suitable power. This is illustrated in Fig. 11.2 (c). A concave lens of suitable power will bring the image back on to the retina and thus the defect is corrected.

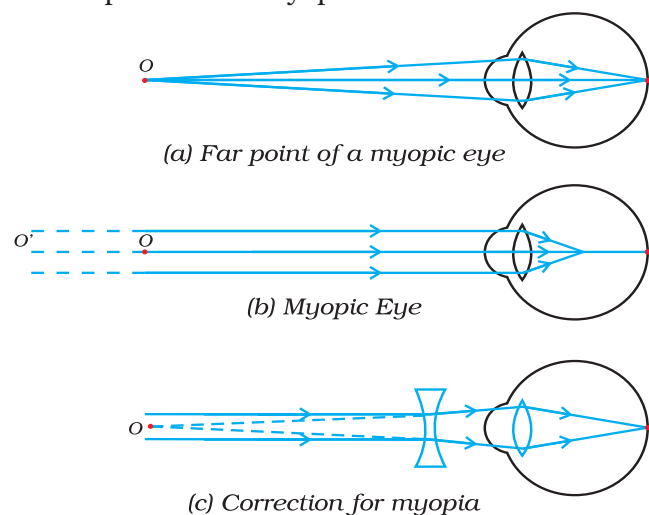

Figure 11.2

(a), (b) The myopic eye, and (c) correction for myopia with a concave lens

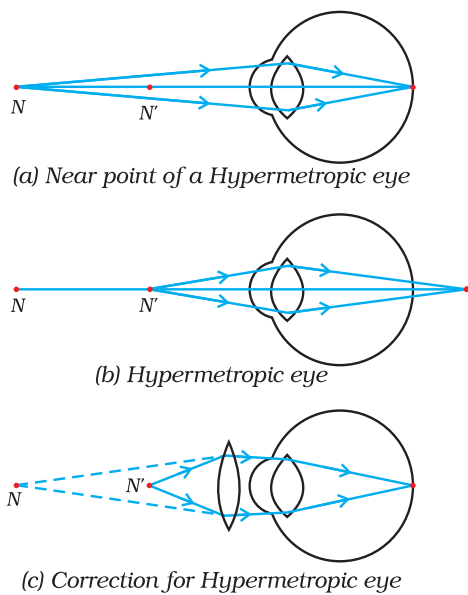

Figure 11.3

(a), (b) The hypermetropic eye, and (c) correction for hypermetropia

N = Near point of a hypermetropic eye.

N' = Near point of a normal eye.

(b) Hypermetropia

Hypermetropia is also known as far-sightedness. A person with hypermetropia can see distant objects clearly but cannot see nearby objects distinctly. The near point, for the person, is farther away from the normal near point (25 cm). Such a person has to keep a reading material much beyond 25 cm from the eye for comfortable reading. This is because the light rays from a closeby object are focussed at a point behind the retina as shown in Fig. 11.3 (b). This defect arises either because (i) the focal length of the eye lens is too long, or (ii) the eyeball has become too small. This defect can be corrected by using a convex lens of appropriate power. This is illustrated in Fig. 11.3 (c). Eye-glasses with converging lenses provide the additional focussing power required for forming the image on the retina.

(c) Presbyopia

The power of accommodation of the eye usually decreases with ageing. For most people, the near point gradually recedes away. They find it difficult to see nearby objects comfortably and distinctly without corrective eye-glasses. This defect is called Presbyopia. It arises due to the gradual weakening of the ciliary muscles and diminishing flexibility of the eye lens.

Sometimes, a person may suffer from both myopia and hypermetropia. Such people often require bi-focal lenses. A common type of bi-focal lenses consists of both concave and convex lenses. The upper portion consists of a concave lens. It facilitates distant vision. The lower part is a convex lens. It facilitates near vision.

These days, it is possible to correct the refractive defects with contact lenses or through surgical interventions.

Q U E S T I O N S

1. What is meant by power of accommodation of the eye?
2. A person with a myopic eye cannot see objects beyond 1.2 m distinctly. What should be the type of the corrective lens used to restore proper vision?
3. What is the far point and near point of the human eye with normal vision?
4. A student has difficulty reading the blackboard while sitting in the last row. What could be the defect the child is suffering from? How can it be corrected?



Think it over



*You talk of wondrous things you see,
You say the sun shines bright;
I feel him warm, but how can he
Or make it day or night?*

— C. CIBBER

Do you know that our eyes can live even after our death? By donating our eyes after we die, we can light the life of a blind person.

About 35 million people in the developing world are blind and most of them can be cured. About 4.5 million people with corneal blindness can be cured through corneal transplantation of donated eyes. Out of these 4.5 million, 60% are children below the age of 12. So, if we have got the gift of vision, why not pass it on to somebody who does not have it? What do we have to keep in mind when eyes have to be donated?

- Eye donors can belong to any age group or sex. People who use spectacles, or those operated for cataract, can still donate the eyes. People who are diabetic, have hypertension, asthma patients and those without communicable diseases can also donate eyes.
- Eyes must be removed within 4-6 hours after death. Inform the nearest eye bank immediately.
- The eye bank team will remove the eyes at the home of the deceased or at a hospital.
- Eye removal takes only 10-15 minutes. It is a simple process and does not lead to any disfigurement.
- Persons who were infected with or died because of AIDS, Hepatitis B or C, rabies, acute leukaemia, tetanus, cholera, meningitis or encephalitis cannot donate eyes.

An eye bank collects, evaluates and distributes the donated eyes. All eyes donated are evaluated using strict medical standards. Those donated eyes found unsuitable for transplantation are used for valuable research and medical education. The identities of both the donor and the recipient remain confidential.

One pair of eyes gives vision to up to FOUR CORNEAL BLIND PEOPLE.

11.3 REFRACTION OF LIGHT THROUGH A PRISM

You have learnt how light gets refracted through a rectangular glass slab. For parallel refracting surfaces, as in a glass slab, the emergent ray is parallel to the incident ray. However, it is slightly displaced laterally. How would light get refracted through a transparent prism? Consider a triangular glass prism. It has two triangular bases and three rectangular lateral surfaces. These surfaces are inclined to each other. The angle between its two lateral faces is called the angle of the prism. Let us now do an activity to study the refraction of light through a triangular glass prism.

Activity 11.1

- Fix a sheet of white paper on a drawing board using drawing pins.
- Place a glass prism on it in such a way that it rests on its triangular base. Trace the outline of the prism using a pencil.
- Draw a straight line PE inclined to one of the refracting surfaces, say AB, of the prism.
- Fix two pins, say at points P and Q, on the line PE as shown in Fig. 11.4.
- Look for the images of the pins, fixed at P and Q, through the other face AC.
- Fix two more pins, at points R and S, such that the pins at R and S and the images of the pins at P and Q lie on the same straight line.
- Remove the pins and the glass prism.
- The line PE meets the boundary of the prism at point E (see Fig. 11.4). Similarly, join and produce the points R and S. Let these lines meet the boundary of the prism at E and F, respectively. Join E and F.
- Draw perpendiculars to the refracting surfaces AB and AC of the prism at points E and F, respectively.
- Mark the angle of incidence ($\angle i$), the angle of refraction ($\angle r$) and the angle of emergence ($\angle e$) as shown in Fig. 11.4.

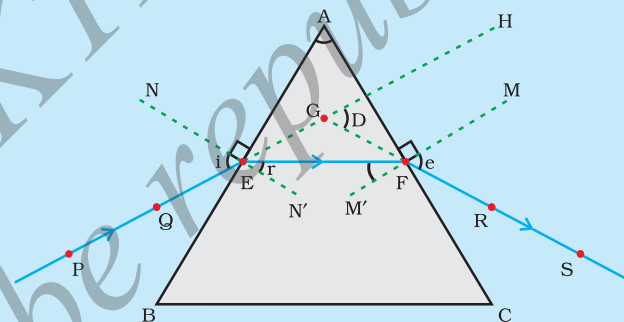

PE - Incident ray	$\angle i$ - Angle of incidence
EF - Refracted ray	$\angle r$ - Angle of refraction
FS - Emergent ray	$\angle e$ - Angle of emergence
$\angle A$ - Angle of the prism	$\angle D$ - Angle of deviation

Figure 11.4 Refraction of light through a triangular glass prism

Here PE is the incident ray, EF is the refracted ray and FS is the emergent ray. You may note that a ray of light is entering from air to glass at the first surface AB. The light ray on refraction has bent towards the normal. At the second surface AC, the light ray has entered from glass to air. Hence it has bent away from normal. Compare the angle of incidence and the angle of refraction at each refracting surface of the prism. Is this similar to the kind of bending that occurs in a glass slab? The peculiar shape of the prism makes the emergent ray bend at an angle to the direction of the incident ray. This angle is called the angle of deviation. In this case $\angle D$ is the angle of deviation. Mark the angle of deviation in the above activity and measure it.

11.4 DISPERSION OF WHITE LIGHT BY A GLASS PRISM

You must have seen and appreciated the spectacular colours in a rainbow. How could the white light of the Sun give us various colours of the rainbow? Before we take up this question, we shall first go back to the refraction of light through a prism. The inclined refracting surfaces of a glass prism show exciting phenomenon. Let us find it out through an activity.

Activity 11.2

- Take a thick sheet of cardboard and make a small hole or narrow slit in its middle.
- Allow sunlight to fall on the narrow slit. This gives a narrow beam of white light.
- Now, take a glass prism and allow the light from the slit to fall on one of its faces as shown in Fig. 11.5.
- Turn the prism slowly until the light that comes out of it appears on a nearby screen.
- What do you observe? You will find a beautiful band of colours. Why does this happen?

The prism has probably split the incident white light into a band of colours. Note the colours that appear at the two ends of the colour band. What is the sequence of colours that you see on the screen? The various colours seen are Violet, Indigo, Blue, Green, Yellow, Orange and Red, as shown in Fig. 11.5. The acronym VIBGYOR will help you to remember the sequence of colours. The band of the coloured components of a light beam is called its spectrum. You might not be able to see all the colours separately.

Yet something makes each colour distinct from the other. The splitting of light into its component colours is called dispersion.

You have seen that white light is dispersed into its seven-colour components by a prism. Why do we get these colours? Different colours of light bend through different angles with respect to the incident ray, as they pass through a prism. The red light bends the least while the violet the most. Thus the rays of each colour emerge along different paths and thus become distinct. It is the band of distinct colours that we see in a spectrum.

Isaac Newton was the first to use a glass prism to obtain the spectrum of sunlight. He tried to split the colours of the spectrum of white light further by using another similar prism. However, he could not get any more colours. He then placed a second identical prism in an inverted position with respect to the first prism, as shown in Fig. 11.6. This

The Human Eye and the Colourful World

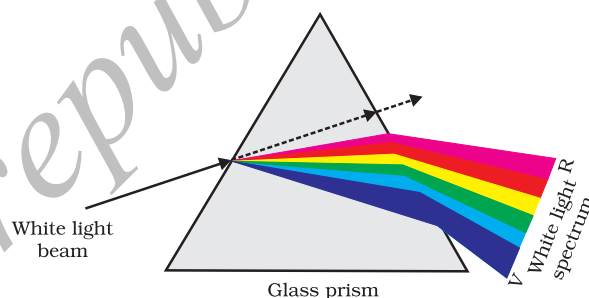

Figure 11.5 Dispersion of white light by the glass prism

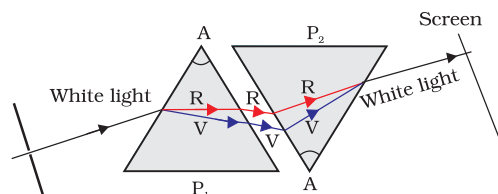

Figure 11.6 Recombination of the spectrum of white light



Figure 11.7
Rainbow in the sky

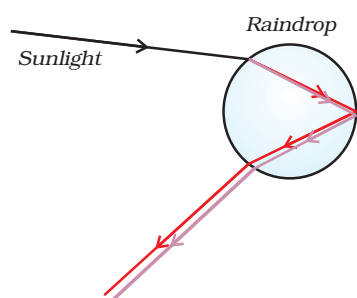

Figure 11.8
Rainbow formation

allowed all the colours of the spectrum to pass through the second prism. He found a beam of white light emerging from the other side of the second prism. This observation gave Newton the idea that the sunlight is made up of seven colours.

Any light that gives a spectrum similar to that of sunlight is often referred to as white light.

A rainbow is a natural spectrum appearing in the sky after a rain shower (Fig. 11.7). It is caused by dispersion of sunlight by tiny water droplets, present in the atmosphere. A rainbow is always formed in a direction opposite to that of the Sun. The water droplets act like small prisms. They refract and disperse the incident sunlight, then reflect it internally, and finally refract it again when it comes out of the raindrop (Fig. 11.8). Due to the dispersion of light and internal reflection, different colours reach the observer's eye.

You can also see a rainbow on a sunny day when you look at the sky through a waterfall or through a water fountain, with the Sun behind you.

11.5 ATMOSPHERIC REFRACTION

You might have observed the apparent random wavering or flickering of objects seen through a turbulent stream of hot air rising above a fire or a radiator. The air just above the fire becomes hotter than the air further up. The hotter air is lighter (less dense) than the cooler air above it, and has a refractive index slightly less than that of the cooler air. Since the physical conditions of the refracting medium (air) are not stationary, the apparent position of the object, as seen through the hot air, fluctuates. This wavering is thus an effect of atmospheric refraction (refraction of light by the earth's atmosphere) on a small scale in our local environment. The twinkling of stars is a similar phenomenon on a much larger scale. Let us see how we can explain it.

Twinkling of stars

The twinkling of a star is due to atmospheric refraction of starlight. The starlight, on entering the earth's atmosphere, undergoes refraction continuously before it reaches the earth. The atmospheric refraction occurs in a medium of gradually changing refractive index. Since the atmosphere bends starlight towards the normal, the apparent position of the star is slightly different from its actual position. The star appears slightly higher (above) than its actual position when viewed near the horizon (Fig. 11.9). Further, this apparent position of the star is not stationary, but keeps on changing slightly, since the physical conditions of the earth's atmosphere are not stationary, as was the case in the previous paragraph. Since the stars are very distant, they approximate point-sized sources of light. As the path of rays of light coming from the star goes on varying slightly, the apparent position of the star fluctuates and the amount of

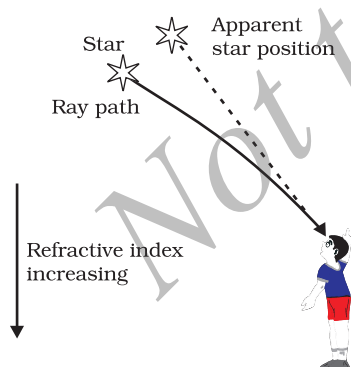

Figure 11.9
Apparent star position due to atmospheric refraction

starlight entering the eye flickers – the star sometimes appears brighter, and at some other time, fainter, which is the twinkling effect.

Why don't the planets twinkle? The planets are much closer to the earth, and are thus seen as extended sources. If we consider a planet as a collection of a large number of point-sized sources of light, the total variation in the amount of light entering our eye from all the individual point-sized sources will average out to zero, thereby nullifying the twinkling effect.

Advance sunrise and delayed sunset

The Sun is visible to us about 2 minutes before the actual sunrise, and about 2 minutes after the actual sunset because of atmospheric refraction. By actual sunrise, we mean the actual crossing of the horizon by the Sun. Fig. 11.10 shows the actual and apparent positions of the Sun with respect to the horizon. The time difference between actual sunset and the apparent sunset is about 2 minutes. The apparent flattening of the Sun's disc at sunrise and sunset is also due to the same phenomenon.

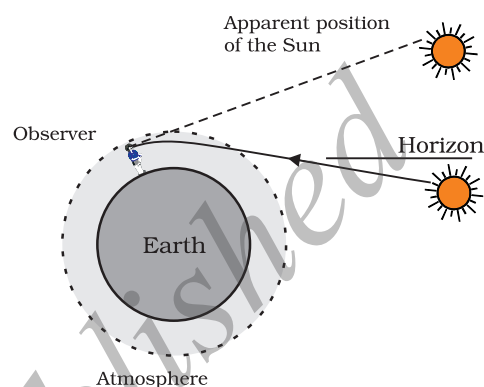

Figure 11.10
Atmospheric refraction effects at sunrise and sunset

11.6 SCATTERING OF LIGHT

The interplay of light with objects around us gives rise to several spectacular phenomena in nature. The blue colour of the sky, colour of water in deep sea, the reddening of the sun at sunrise and the sunset are some of the wonderful phenomena we are familiar with. In the previous class, you have learnt about the scattering of light by colloidal particles. The path of a beam of light passing through a true solution is not visible. However, its path becomes visible through a colloidal solution where the size of the particles is relatively larger.

11.6.1 Tyndall Effect

The earth's atmosphere is a heterogeneous mixture of minute particles. These particles include smoke, tiny water droplets, suspended particles of dust and molecules of air. When a beam of light strikes such fine particles, the path of the beam becomes visible. The light reaches us, after being reflected diffusely by these particles. The phenomenon of scattering of light by the colloidal particles gives rise to Tyndall effect which you have studied in Class IX. This phenomenon is seen when a fine beam of sunlight enters a smoke-filled room through a small hole. Thus, scattering of light makes the particles visible. Tyndall effect can also be observed when sunlight passes through a canopy of a dense forest. Here, tiny water droplets in the mist scatter light.

The colour of the scattered light depends on the size of the scattering particles. Very fine particles scatter mainly blue light while particles of larger size scatter light of longer wavelengths. If the size of the scattering particles is large enough, then, the scattered light may even appear white.

11.6.2 Why is the colour of the clear Sky Blue?

The molecules of air and other fine particles in the atmosphere have size smaller than the wavelength of visible light. These are more effective in scattering light of shorter wavelengths at the blue end than light of longer wavelengths at the red end. The red light has a wavelength about 1.8 times greater than blue light. Thus, when sunlight passes through the atmosphere, the fine particles in air scatter the blue colour (shorter wavelengths) more strongly than red. The scattered blue light enters our eyes. If the earth had no atmosphere, there would not have been any scattering. Then, the sky would have looked dark. The sky appears dark to passengers flying at very high altitudes, as scattering is not prominent at such heights.

You might have observed that 'danger' signal lights are red in colour. Do you know why? The red is least scattered by fog or smoke. Therefore, it can be seen in the same colour at a distance.

11.6.3 Colour of the Sun at Sunrise and Sunset

Have you seen the sky and the Sun at sunset or sunrise? Have you wondered as to why the Sun and the surrounding sky appear red? Let us do an activity to understand the blue colour of the sky and the reddish appearance of the Sun at the sunrise or sunset.

Activity 11.3

- Place a strong source (S) of white light at the focus of a converging lens (L_1). This lens provides a parallel beam of light.
- Allow the light beam to pass through a transparent glass tank (T) containing clear water.
- Allow the beam of light to pass through a circular hole (c) made in a cardboard. Obtain a sharp image of the circular hole on a screen (MN) using a second converging lens (L_2), as shown in Fig. 11.11.
- Dissolve about 200 g of sodium thiosulphate (hypo) in about 2 L of clean water taken in the tank. Add about 1 to 2 mL of concentrated sulphuric acid to the water. What do you observe?

You will find fine microscopic sulphur particles precipitating in about 2 to 3 minutes. As the sulphur particles begin to form, you can observe

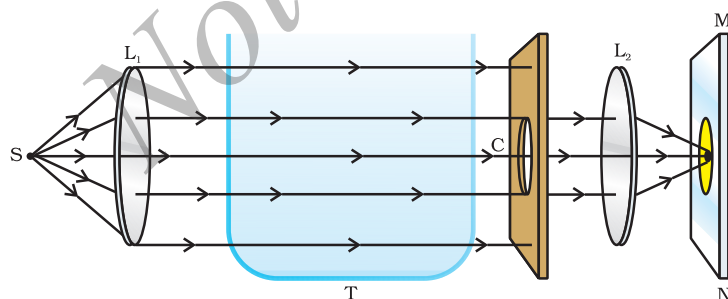

Figure 11.11
An arrangement for observing scattering of light in colloidal solution

the blue light from the three sides of the glass tank. This is due to scattering of short wavelengths by minute colloidal sulphur particles. Observe the colour of the transmitted light from the fourth side of the glass tank facing the circular hole. It is interesting to observe at first the orange red colour and then bright crimson red colour on the screen.

This activity demonstrates the scattering of light that helps you to understand the bluish colour of the sky and the reddish appearance of the Sun at the sunrise or the sunset.

Light from the Sun near the horizon passes through thicker layers of air and larger distance in the earth's atmosphere before reaching our eyes (Fig. 11.12).

However, light from the Sun overhead would travel relatively shorter distance. At noon, the Sun appears white as only a little of the blue and violet colours are scattered. Near the horizon, most of the blue light and shorter wavelengths are scattered away by the particles. Therefore, the light that reaches our eyes is of longer wavelengths. This gives rise to the reddish appearance of the Sun.

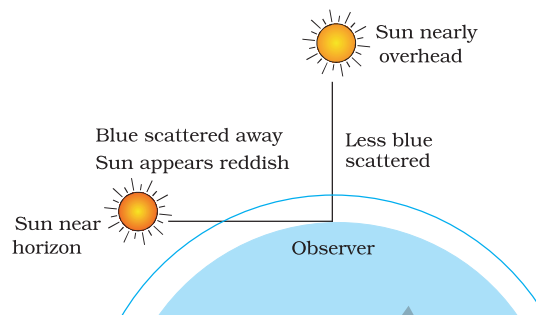

Figure 11.12
Reddening of the Sun at sunrise and sunset

What you have learnt

- The ability of the eye to focus on both near and distant objects, by adjusting its focal length, is called the accommodation of the eye.
- The smallest distance, at which the eye can see objects clearly without strain, is called the near point of the eye or the least distance of distinct vision. For a young adult with normal vision, it is about 25 cm.
- The common refractive defects of vision include myopia, hypermetropia and presbyopia. Myopia (short-sightedness – the image of distant objects is focussed before the retina) is corrected by using a concave lens of suitable power. Hypermetropia (far-sightedness – the image of nearby objects is focussed beyond the retina) is corrected by using a convex lens of suitable power. The eye loses its power of accommodation at old age.
- The splitting of white light into its component colours is called dispersion.
- Scattering of light causes the blue colour of sky and the reddening of the Sun at sunrise and sunset.

EXERCISES

1. The human eye can focus on objects at different distances by adjusting the focal length of the eye lens. This is due to
 - (a) presbyopia.
 - (b) accommodation.
 - (c) near-sightedness.
 - (d) far-sightedness.

2. The human eye forms the image of an object at its
(a) cornea. (b) iris. (c) pupil. (d) retina.
3. The least distance of distinct vision for a young adult with normal vision is about
(a) 25 m. (b) 2.5 cm. (c) 25 cm. (d) 2.5 m.
4. The change in focal length of an eye lens is caused by the action of the
(a) pupil. (b) retina.
(c) ciliary muscles. (d) iris.
5. A person needs a lens of power -5.5 dioptres for correcting his distant vision. For correcting his near vision he needs a lens of power $+1.5$ dioptre. What is the focal length of the lens required for correcting (i) distant vision, and (ii) near vision?
6. The far point of a myopic person is 80 cm in front of the eye. What is the nature and power of the lens required to correct the problem?
7. Make a diagram to show how hypermetropia is corrected. The near point of a hypermetropic eye is 1 m. What is the power of the lens required to correct this defect? Assume that the near point of the normal eye is 25 cm.
8. Why is a normal eye not able to see clearly the objects placed closer than 25 cm?
9. What happens to the image distance in the eye when we increase the distance of an object from the eye?
10. Why do stars twinkle?
11. Explain why the planets do not twinkle.
12. Why does the Sun appear reddish early in the morning?
13. Why does the sky appear dark instead of blue to an astronaut?

CHAPTER 14

Sources of Energy

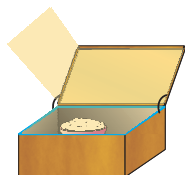

In Class IX, we learnt that the total energy during a physical or chemical process is conserved. Why, then, do we hear so much about the energy crisis? If energy can neither be created nor destroyed, we should have no worries! We should be able to perform endless activities without thinking about energy resources!

This riddle can be solved if we recall what else we learnt about energy. Energy comes in different forms and one form can be converted to another. For example, if we drop a plate from a height, the potential energy of the plate is converted mostly to sound energy when it hits the ground. If we light a candle, the process is highly exothermic so that the chemical energy in the wax is converted to heat energy and light energy on burning. What other products are obtained when we burn a candle?

The total energy during a physical or chemical process remains the same but suppose we consider the burning candle again – can we somehow put together the heat and light generated along with the products of the reaction to get back the chemical energy in the form of wax?

Let us consider another example. Suppose we take 100 mL of water which has a temperature of 348 K (75 C) and leave it in a room where the temperature is 298 K (25 C). What will happen? Is there any way of collecting all the heat lost to the environment and making the water hot once it has cooled down?

In any example that we consider, we will see that energy, in the usable form, is dissipated to the surroundings in less usable forms. Hence, any source of energy we use, to do work, is consumed and cannot be used again.

14.1 WHAT IS A GOOD SOURCE OF ENERGY?

What can then be considered a good source of energy? We, in our daily lives, use energy from various sources for doing work. We use diesel to run our trains. We use electricity to light our street-lamps. Or we use energy in our muscles to cycle to school.

Activity 14.1

- List four forms of energy that you use from morning, when you wake up, till you reach the school.
- From where do we get these different forms of energy?
- Can we call these 'sources' of energy? Why or why not?

The muscular energy for carrying out physical work, electrical energy for running various appliances, chemical energy for cooking food or running a vehicle all come from some source. We need to know how do we select the source needed for obtaining the energy in its usable form.

Activity 14.2

- Consider the various options we have when we choose a fuel for cooking our food.
- What are the criteria you would consider when trying to categorise something as a good fuel?
- Would your choice be different if you lived
 - (a) in a forest?
 - (b) in a remote mountain village or small island?
 - (c) in New Delhi?
 - (d) lived five centuries ago?
- How are the factors different in each case?

After going through the two activities above, we can see that the particular source of energy, or fuel, we select for performing some work depends on many different factors. For example, while selecting a fuel, we would ask ourselves the following questions.

- (i) How much heat does it release on burning?
- (ii) Does it produce a lot of smoke?
- (iii) Is it easily available?

Can you think of three more relevant questions to ask about a fuel?

Given the range of fuels we have today, what are the factors which would limit our choices when it comes to a particular task like cooking our food? Would the fuel selected also depend on the work to be done? For example, would we choose one fuel for cooking and another for heating the room in winter?

We could then say that a good source of energy would be one

- which would do a large amount of work per unit volume or mass,
- be easily accessible,
- be easy to store and transport, and
- perhaps most importantly, be economical.

Q U E S T I O N S

1. What is a good source of energy?
2. What is a good fuel?
3. If you could use any source of energy for heating your food, which one would you use and why?



14.2 CONVENTIONAL SOURCES OF ENERGY

14.2.1 Fossil Fuels

In ancient times, wood was the most common source of heat energy. The energy of flowing water and wind was also used for limited activities. Can you think of some of these uses? The exploitation of coal as a source of energy made the industrial revolution possible. Increasing industrialisation has led to a better quality of life all over the world. It has also caused the global demand for energy to grow at a tremendous rate. The growing demand for energy was largely met by the fossil fuels – coal and petroleum. Our technologies were also developed for using these energy sources. But these fuels were formed over millions of years ago and there are only limited reserves. The fossil fuels are non-renewable sources of energy, so we need to conserve them. If we were to continue consuming these sources at such alarming rates, we would soon run out of energy! In order to avoid this, alternate sources of energy were explored. But we continue to be largely dependent on fossil fuels for most of our energy requirements (Fig. 14.1).

Burning fossil fuels has other disadvantages too. We learnt in Class IX about the air pollution caused by burning of coal or petroleum products. The oxides of carbon, nitrogen and sulphur that are released on burning fossil fuels are acidic oxides. These lead to acid rain which affects our water and soil resources. In addition to the problem of air pollution, recall the green-house effect of gases like carbon dioxide.

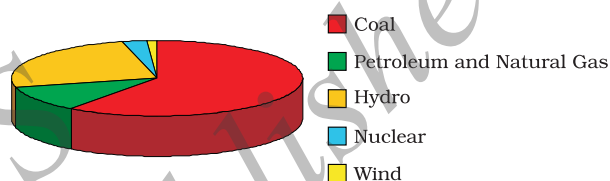

Figure 14.1
Pie-chart showing the major sources of energy for our requirements in India

Think it over

How would our lives change if we could no longer get electricity supply? The availability of electrical energy to each individual in a country is one of the parameters to measure the growth of the country.

The pollution caused by burning fossil fuels can be somewhat reduced by increasing the efficiency of the combustion process and using various techniques to reduce the escape of harmful gases and ashes into the surroundings. Besides being used directly for various purposes – in gas stoves and vehicles, do you know fossil fuels are the major fuels used for generating electricity? Let us produce some electricity at our own small plant in the class and see what goes into producing our favourite form of energy.

Activity 14.3

- Take a table-tennis ball and make three slits into it.
- Put semicircular (\frown) fins cut out of a metal sheet into these slits.
- Pivot the tennis ball on an axle through its centre with a straight metal wire fixed to a rigid support. Ensure that the tennis ball rotates freely about the axle.

- Now connect a cycle dynamo to this.
- Connect a bulb in series.
- Direct a jet of water or steam produced in a pressure cooker at the fins (Fig. 14.2). What do you observe?

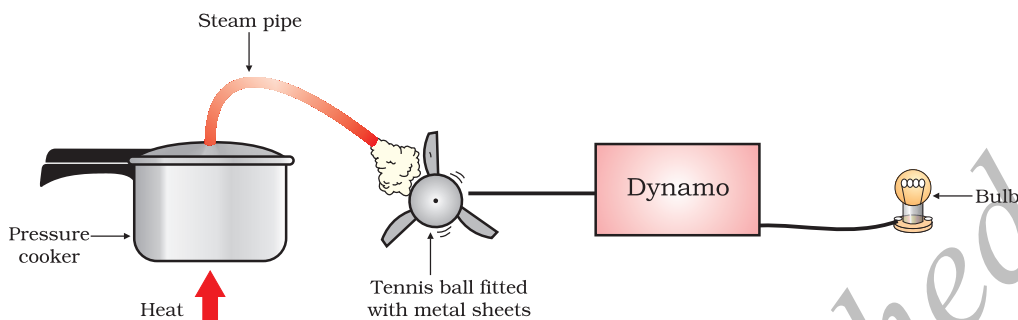

Figure 14.2 A model to demonstrate the process of thermoelectric production

This is our turbine for generating electricity. The simplest turbines have one moving part, a rotor-blade assembly. The moving fluid acts on the blades to spin them and impart energy to the rotor. Thus, we see that basically we need to move the fan, the rotor blade, with speed which would turn the shaft of the dynamo and convert the mechanical energy into electrical energy — the form of energy which has become a necessity in today's scenario. The various ways in which this can be done depends upon availability of the resources. We will see how various sources of energy can be harnessed to run the turbine and generate electricity in the following sections.

14.2.2 Thermal Power Plant

Large amount of fossil fuels are burnt every day in power stations to heat up water to produce steam which further runs the turbine to generate electricity. The transmission of electricity is more efficient than transporting coal or petroleum over the same distance. Therefore, many thermal power plants are set up near coal or oil fields. The term thermal power plant is used since fuel is burnt to produce heat energy which is converted into electrical energy.

14.2.3 Hydro Power Plants

Another traditional source of energy was the kinetic energy of flowing water or the potential energy of water at a height. Hydro power plants convert the potential energy of falling water into electricity. Since there are very few water-falls which could be used as a source of potential energy, hydro power plants are associated with dams. In the last century, a large number of dams were built all over the world. As we can see from Fig. 14.1, a quarter of our energy requirement in India is met by hydro power plants.

In order to produce hydel electricity, high-rise dams are constructed on the river to obstruct the flow of water and thereby collect water in larger reservoirs. The water level rises and in this process the kinetic energy of flowing water gets transformed into potential energy. The water from the high level in the dam is carried through pipes, to the turbine, at the bottom of the dam (Fig. 14.3). Since the water in the reservoir would be refilled each time it rains (hydro power is a renewable source of energy) we would not have to worry about hydro electricity sources getting used up the way fossil fuels would get finished one day.

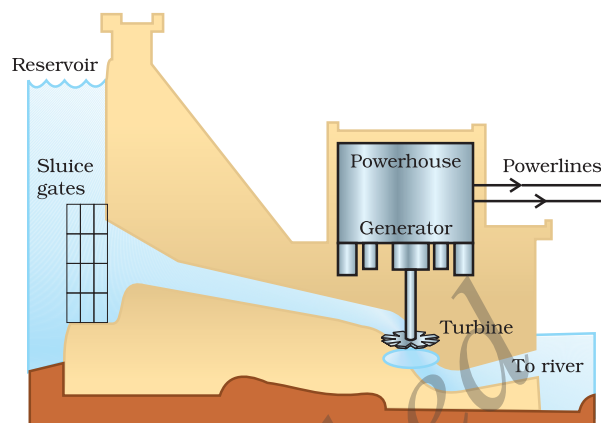

Figure 14.3
A schematic view of a hydro power plant

But, constructions of big dams have certain problems associated with it. The dams can be constructed only in a limited number of places, preferably in hilly terrains. Large areas of agricultural land and human habitation are to be sacrificed as they get submerged. Large eco-systems are destroyed when submerged under the water in dams. The vegetation which is submerged rots under anaerobic conditions and gives rise to large amounts of methane which is also a green-house gas. It creates the problem of satisfactory rehabilitation of displaced people. Opposition to the construction of Tehri Dam on the river Ganga and Sardar Sarovar project on the river Narmada are due to such problems.

14.2.4 Improvements in the Technology for using Conventional Sources of Energy

Bio-Mass

We mentioned earlier that wood has been used as a fuel for a long time. If we can ensure that enough trees are planted, a continuous supply of fire-wood can be assured. You must also be familiar with the use of cow-dung cakes as a fuel. Given the large live-stock population in India, this can also assure us a steady source of fuel. Since these fuels are plant and animal products, the source of these fuels is said to be bio-mass. These fuels, however, do not produce much heat on burning and a lot of smoke is given out when they are burnt. Therefore, technological inputs to improve the efficiency of these fuels are necessary. When wood is burnt in a limited supply of oxygen, water and volatile materials present in it get removed and charcoal is left behind as the residue. Charcoal burns without flames, is comparatively smokeless and has a higher heat generation efficiency.

Similarly, cow-dung, various plant materials like the residue after harvesting the crops, vegetable waste and sewage are decomposed in the absence of oxygen to give bio-gas. Since the starting material is mainly cow-dung, it is popularly known as 'gobar-gas'. Bio-gas is produced in a plant as shown in Fig. 14.4.

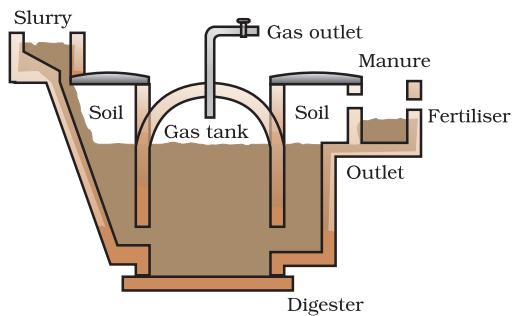

Figure 14.4
Schematic diagram of a bio-gas plant

The plant has a dome-like structure built with bricks. A slurry of cow-dung and water is made in the mixing tank from where it is fed into the digester. The digester is a sealed chamber in which there is no oxygen. Anaerobic micro-organisms that do not require oxygen decompose or break down complex compounds of the cow-dung slurry. It takes a few days for the decomposition process to be complete and generate gases like methane, carbon dioxide, hydrogen and hydrogen sulphide. The bio-gas is stored in the gas tank above the digester from which they are drawn through pipes for use.

Bio-gas is an excellent fuel as it contains up to 75% methane. It burns without smoke, leaves no residue like ash in wood, charcoal and coal burning. Its heating capacity is high. Bio-gas is also used for lighting. The slurry left behind is removed periodically and used as excellent manure, rich in nitrogen and phosphorous. The large-scale utilisation of bio-waste and sewage material provides a safe and efficient method of waste-disposal besides supplying energy and manure. Do you think that bio-mass is a renewable source of energy?



Figure 14.5 A windmill

Wind Energy

We saw in Class IX how unequal heating of the landmass and water bodies by solar radiation generates air movement and causes winds to blow. This kinetic energy of the wind can be used to do work. This energy was harnessed by windmills in the past to do mechanical work. For example, in a water-lifting pump, the rotatory motion of windmill is utilised to lift water from a well. Today, wind energy is also used to generate electricity. A windmill essentially consists of a structure similar to a large electric fan that is erected at some height on a rigid support (Fig. 14.5).

To generate electricity, the rotatory motion of the windmill is used to turn the turbine of the electric generator. The output of a single windmill is quite small and cannot be used for commercial purposes. Therefore, a number of windmills are erected over a large area, which is known as wind energy farm. The energy output of each windmill in a farm is coupled together to get electricity on a commercial scale.

Denmark is called the country of 'winds'. More than 25% of their electricity needs are generated through a vast network of windmills. In terms of total output, Germany is the leader, while India is ranked fifth in harnessing wind energy for the production of electricity. It is estimated that nearly 45,000 MW of electrical power can be generated if India's wind potential is fully exploited. The largest wind energy farm has been established near Kanyakumari in Tamil Nadu and it generates 380 MW of electricity.

Do You Know?

Wind energy is an environment-friendly and efficient source of renewable energy. It requires no recurring expenses for the production of electricity. But there are many limitations in harnessing wind energy. Firstly, wind energy farms can be established only at those places where wind blows for the greater part of a year. The wind speed should also be higher than 15 km/h to maintain the required speed of the turbine. Furthermore, there should be some back-up facilities (like storage cells) to take care of the energy needs during a period when there is no wind. Establishment of wind energy farms requires large area of land. For a 1 MW generator, the farm needs about 2 hectares of land. The initial cost of establishment of the farm is quite high. Moreover, since the tower and blades are exposed to the vagaries of nature like rain, Sun, storm and cyclone, they need a high level of maintenance.

Q U E S T I O N S

1. What are the disadvantages of fossil fuels?
2. Why are we looking at alternate sources of energy?
3. How has the traditional use of wind and water energy been modified for our convenience?

14.3 ALTERNATIVE OR NON-CONVENTIONAL SOURCES OF ENERGY

With technological progress, our demand for energy increases day by day. Our life-styles are also changing, we use machines to do more and more of our tasks. Our basic requirements are also increasing as industrialisation improves our living standards.

Activity 14.4

- Find out from your grand-parents or other elders –
 - (a) how did they go to school?
 - (b) how did they get water for their daily needs when they were young?
 - (c) what means of entertainment did they use?
- Compare the above answers with how you do these tasks now.
- Is there a difference? If yes, in which case more energy from external sources is consumed?

As our demand for energy increases, we need to look for more and more sources of energy. We could develop the technology to use the available or known sources of energy more efficiently and also look to new sources of energy. Any new source of energy we seek to exploit would need specific devices developed with that source in mind. We shall now look at some of the latest sources of energy that we seek to tap, and the technology designed to capture and store energy from that source.

Think it over!

Some people say that if we start living as our ancestors, this would conserve energy and our ecosystem. Do you think this idea is feasible?

14.3.1 Solar Energy

The Sun has been radiating an enormous amount of energy at the present rate for nearly 5 billion years and will continue radiating at that rate for about 5 billion years more. Only a small part of solar energy reaches the outer layer of the earth's atmosphere. Nearly half of it is absorbed while passing through the atmosphere and the rest reaches the earth's surface.

India is lucky to receive solar energy for greater part of the year. It is estimated that during a year India receives the energy equivalent to more than 5,000 trillion kWh. Under clear (cloudless) sky conditions, the daily average varies from 4 to 7 kWh/m². The solar energy reaching unit area at outer edge of the earth's atmosphere exposed perpendicularly to the rays of the Sun at the average distance between the Sun and earth is known as the solar constant. It is estimated to be approximately 1.4 kJ per second per square metre or 1.4 kW/m².

Do You Know?

Activity 14.5

- Take two conical flasks and paint one white and the other black. Fill both with water.
- Place the conical flasks in direct sunlight for half an hour to one hour.
- Touch the conical flasks. Which one is hotter? You could also measure the temperature of the water in the two conical flasks with a thermometer.
- Can you think of ways in which this finding could be used in your daily life?

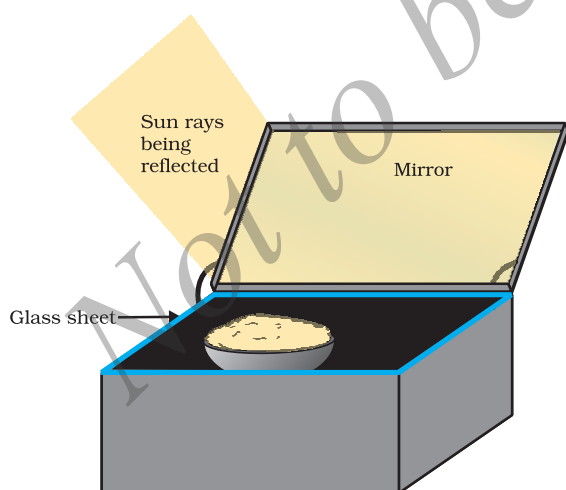

Figure 14.6 A solar cooker

A black surface absorbs more heat as compared to a white or a reflecting surface under identical conditions. Solar cookers (Fig. 14.6) and solar water heaters use this property in their working. Some solar cookers achieve a higher temperature by using mirrors to focus the rays of the Sun. Solar cookers are covered with a glass plate. Recall what we have learnt about the green-house effect. Does this explain why a glass plate is used?

Activity 14.6

- Study the structure and working of a solar cooker and/or a solar water-heater, particularly with regard to how it is insulated and maximum heat absorption is ensured.

- Design and build a solar cooker or water-heater using low-cost material available and check what temperatures are achieved in your system.
- Discuss what would be the advantages and limitations of using the solar cooker or water-heater.

It is easy to see that these devices are useful only at certain times during the day. This limitation of using solar energy is overcome by using solar cells that convert solar energy into electricity. A typical cell develops a voltage of 0.5–1 V and can produce about 0.7 W of electricity when exposed to the Sun. A large number of solar cells are, combined in an arrangement called solar cell panel (Fig. 14.7) that can deliver enough electricity for practical use.

The principal advantages associated with solar cells are that they have no moving parts, require little maintenance and work quite satisfactorily without the use of any focussing device. Another advantage is that they can be set up in remote and inaccessible hamlets or very sparsely inhabited areas in which laying of a power transmission line may be expensive and not commercially viable.

Silicon, which is used for making solar cells, is abundant in nature but availability of the special grade silicon for making solar cells is limited. The entire process of manufacture is still very expensive, silver used for interconnection of the cells in the panel further adds to the cost. In spite of the high cost and low efficiency, solar cells are used for many scientific and technological applications. Artificial satellites and space probes like Mars orbiters use solar cells as the main source of energy. Radio or wireless transmission systems or TV relay stations in remote locations use solar cell panels. Traffic signals, calculators and many toys are fitted with solar cells. The solar cell panels are mounted on specially designed inclined roof tops so that more solar energy is incident over it. The domestic use of solar cells is, however, limited due to its high cost.



Figure 14.7
A solar cell panel

14.3.2 Energy from the Sea

Tidal Energy

Due to the gravitational pull of mainly the moon on the spinning earth, the level of water in the sea rises and falls. If you live near the sea or ever travel to some place near the sea, try and observe how the sea-level changes during the day. This phenomenon is called high and low tides and the difference in sea-levels gives us tidal energy. Tidal energy is harnessed by constructing a dam across a narrow opening to the sea. A turbine fixed at the opening of the dam converts tidal energy to electricity. As you can guess, the locations where such dams can be built are limited.

Wave Energy

Similarly, the kinetic energy possessed by huge waves near the sea-shore can be trapped in a similar manner to generate electricity. The waves are generated by strong winds blowing across the sea. Wave energy would be a viable proposition only where waves are very strong. A wide variety of devices have been developed to trap wave energy for rotation of turbine and production of electricity.

Ocean Thermal Energy

The water at the surface of the sea or ocean is heated by the Sun while the water in deeper sections is relatively cold. This difference in temperature is exploited to obtain energy in ocean-thermal-energy conversion plants. These plants can operate if the temperature difference between the water at the surface and water at depths up to 2 km is 20 K (20 C) or more. The warm surface-water is used to boil a volatile liquid like ammonia. The vapours of the liquid are then used to run the turbine of generator. The cold water from the depth of the ocean is pumped up and condense vapour again to liquid.

The energy potential from the sea (tidal energy, wave energy and ocean thermal energy) is quite large, but efficient commercial exploitation is difficult.

14.3.3 Geothermal Energy

Due to geological changes, molten rocks formed in the deeper hot regions of earth's crust are pushed upward and trapped in certain regions called 'hot spots'. When underground water comes in contact with the hot spot, steam is generated. Sometimes hot water from that region finds outlets at the surface. Such outlets are known as hot springs. The steam trapped in rocks is routed through a pipe to a turbine and used to generate electricity. The cost of production would not be much, but there are very few commercially viable sites where such energy can be exploited. There are number of power plants based on geothermal energy operational in New Zealand and United States of America.

14.3.4 Nuclear Energy

How is nuclear energy generated? In a process called nuclear fission, the nucleus of a heavy atom (such as uranium, plutonium or thorium), when bombarded with low-energy neutrons, can be split apart into lighter nuclei. When this is done, a tremendous amount of energy is released if the mass of the original nucleus is just a little more than the sum of the masses of the individual products. The fission of an atom of uranium, for example, produces 10 million times the energy produced by the combustion of an atom of carbon from coal. In a nuclear reactor designed for electric power generation, such nuclear 'fuel' can be part of a self-sustaining fission chain reaction that releases energy at a controlled rate. The released energy can be used to produce steam and further generate electricity.

In a nuclear fission, the difference in mass, Δm , between the original nucleus and the product nuclei gets converted to energy E at a rate governed by the famous equation,

$$E = \Delta m c^2,$$

first derived by Albert Einstein in 1905, where c is the speed of light in vacuum. In nuclear science, energy is often expressed in units of electron volts (eV): $1 \text{ eV} = 1.602 \times 10^{-19}$ joules. It is easy to check from the above equation that 1 atomic mass unit (u) is equivalent to about 931 mega electron volts (MeV) of energy.

Do You Know?

Nuclear power reactors located at Tarapur (Maharashtra), Rana Pratap Sagar (Rajasthan), Kalpakkam (Tamil Nadu), Narora (UP), Kakrapar (Gujarat) and Kaiga (Karnataka) have the installed capacity of less than 3% of the total electricity generation capacity of our country. However, many industrialised countries are meeting more than 30% of their electrical power needs from nuclear reactors.

The major hazard of nuclear power generation is the storage and disposal of spent or used fuels – the uranium still decaying into harmful subatomic particles (radiations). Improper nuclear-waste storage and disposal result in environmental contamination. Further, there is a risk of accidental leakage of nuclear radiation. The high cost of installation of a nuclear power plant, high risk of environmental contamination and limited availability of uranium makes large-scale use of nuclear energy prohibitive.

Nuclear energy was first used for destructive purposes before nuclear power stations were designed. The fundamental physics of the fission chain reaction in a nuclear weapon is similar to the physics of a controlled nuclear reactor, but the two types of device are engineered quite differently.

Nuclear fusion

Currently all commercial nuclear reactors are based on nuclear fission. But there is another possibility of nuclear energy generation by a safer process called nuclear fusion. Fusion means joining lighter nuclei to make a heavier nucleus, most commonly hydrogen or hydrogen isotopes to create helium, such as



It releases a tremendous amount of energy, according to the Einstein equation, as the mass of the product is little less than the sum of the masses of the original individual nuclei.

Such nuclear fusion reactions are the source of energy in the Sun and other stars. It takes considerable energy to force the nuclei to fuse. The conditions needed for this process are extreme – millions of degrees of temperature and millions of pascals of pressure.

The hydrogen bomb is based on thermonuclear fusion reaction. A nuclear bomb based on the fission of uranium or plutonium is placed at the core of the hydrogen bomb. This nuclear bomb is embedded in a substance which contains deuterium and lithium. When the nuclear bomb (based on fission) is detonated, the temperature of this substance is raised to 10^7 K in a few microseconds. The high temperature generates sufficient energy for the light nuclei to fuse and a devastating amount of energy is released.

Do You Know?

Activity 14.7

- Discuss in class the question of what is the ultimate source of energy for bio-mass, wind and ocean thermal energy.
- Is geothermal energy and nuclear energy different in this respect? Why?
- Where would you place hydro electricity and wave energy?

Q U E S T I O N S

1. What kind of mirror – concave, convex or plain – would be best suited for use in a solar cooker? Why?
2. What are the limitations of the energy that can be obtained from the oceans?
3. What is geothermal energy?
4. What are the advantages of nuclear energy?

14.4 ENVIRONMENTAL CONSEQUENCES

We have studied various sources of energy in the previous sections. Exploiting any source of energy disturbs the environment in some way or the other. In any given situation, the source we would choose depends on factors such as the ease of extracting energy from that source, the economics of extracting energy from the source, the efficiency of the technology available and the environmental damage that will be caused by using that source. Though we talk of 'clean' fuels like CNG, it would be more exact to say that a particular source is cleaner than the other. We have already seen that burning fossil fuels causes air pollution. In some cases, the actual operation of a device like the solar cell may be pollution-free, but the assembly of the device would have caused some environmental damage. Research continues in these areas to produce longer lasting devices that will cause less damage throughout their life.

Activity 14.8

- Gather information about various energy sources and how each one affects the environment.
- Debate the merits and demerits of each source and select the best source of energy on this basis.

Q U E S T I O N S

1. Can any source of energy be pollution-free? Why or why not?
2. Hydrogen has been used as a rocket fuel. Would you consider it a cleaner fuel than CNG? Why or why not?

14.5 HOW LONG WILL AN ENERGY SOURCE LAST US?

We saw earlier that we cannot depend on the fossil fuels for much longer. Such sources that will get depleted some day are said to be exhaustible sources or non-renewable sources of energy. On the other hand, if we manage bio-mass by replacing the trees we cut down for fire-wood, we can be assured of a constant supply of energy at a particular rate. Such energy sources that can be regenerated are called renewable sources of energy.

Renewable energy is available in our natural environment, in the form of some continuing or repetitive currents of energy, or is stored in such large underground reservoirs that the rate of depletion of the reservoir because of extraction of usable energy is practically negligible.

Activity 14.9

- Debate the following two issues in class.
 - (a) The estimated coal reserves are said to be enough to last us for another two hundred years. Do you think we need to worry about coal getting depleted in this case? Why or why not?
 - (b) It is estimated that the Sun will last for another five billion years. Do we have to worry about solar energy getting exhausted? Why or why not?
- On the basis of the debate, decide which energy sources can be considered (i) exhaustible, (ii) inexhaustible, (iii) renewable and (iv) non-renewable. Give your reasons for each choice.

Q U E S T I O N S

1. Name two energy sources that you would consider to be renewable. Give reasons for your choices.
2. Give the names of two energy sources that you would consider to be exhaustible. Give reasons for your choices.

What you have learnt

- Our energy requirements increase with our standard of living.
- In order to fulfil our energy requirements, we try to improve the efficiency of energy usage and also try and exploit new sources of energy.
- We also need to look for new sources of energy because the conventional sources of energy like fossil fuels are in danger of getting exhausted soon.
- The energy source we select would depend on factors like the ease and cost of extracting energy from the source, the efficiency of the technology available for using that source of energy and the environmental impact of using that source.
- Many of the sources ultimately derive their energy from the Sun.

E X E R C I S E S

1. A solar water heater cannot be used to get hot water on
 - (a) a sunny day.
 - (b) a cloudy day.
 - (c) a hot day.
 - (d) a windy day.

2. Which of the following is not an example of a bio-mass energy source?
(a) wood (b) *gobar-gas*
(c) nuclear energy (d) coal
3. Most of the sources of energy we use represent stored solar energy. Which of the following is not ultimately derived from the Sun's energy?
(a) geothermal energy (b) wind energy
(c) nuclear energy (d) bio-mass.
4. Compare and contrast fossil fuels and the Sun as direct sources of energy.
5. Compare and contrast bio-mass and hydro electricity as sources of energy.
6. What are the limitations of extracting energy from—
(a) the wind? (b) waves? (c) tides?
7. On what basis would you classify energy sources as
(a) renewable and non-renewable?
(b) exhaustible and inexhaustible?
Are the options given in (a) and (b) the same?
8. What are the qualities of an ideal source of energy?
9. What are the advantages and disadvantages of using a solar cooker? Are there places where solar cookers would have limited utility?
10. What are the environmental consequences of the increasing demand for energy? What steps would you suggest to reduce energy consumption?

CHAPTER 16

Sustainable Management of Natural Resources



'Living in harmony with nature' is not new to us. Sustainable living has always been an integral part of India's tradition and culture. It has been integrated with our long-lasting traditions and practices, customs, art and crafts, festivals, food, beliefs, rituals and folklore. Ingrained within us is the philosophy that 'entire natural world be in harmony' which is reflected in the famous phrase in Sanskrit '*Vasudhaiv kutumbakam*' that means "the entire earth is one family". The phrase is mentioned in 'Mahaupanishad', that is probably a part of the ancient Indian text, *Atharva Veda*.

In Class IX we have already learnt about some natural resources like soil, air and water and how various components are cycled over and over again in nature. Also, we learnt in the previous chapter about the pollution of these resources because of some of our activities. In this chapter, we shall look at some of our resources and how we are using them. Maybe we should also think about how we ought to be using our resources so as to sustain them and conserve our environment. We shall be looking at our natural resources like forests, wildlife, water, coal and petroleum and see what are the issues at stake in deciding how these resources are to be managed for sustainable development along with the input from our traditional practices.

We often hear or read about environmental problems. These are often global-level problems and we feel helpless to bring any change. There are international laws and regulations, and then there are our own national laws and acts for environmental protection. There are also national and international organisations working towards protecting our environment.

Activity 16.1

- Find out about the international norms to regulate the emission of carbon dioxide.
- Have a discussion in class about how we can contribute towards meeting those norms.

Activity 16.2

- There are a number of organisations that seek to spread awareness about our environment and promote activities and attitudes that lead to the conservation of our environment and natural resources. Find out about the organisation(s) active in your neighbourhood/village/town/city.
- Find out how you can contribute towards the same cause.

Awareness about the problems caused by unthinkingly exploiting our resources has been a fairly recent phenomenon in our society. And once this awareness rises, some action is usually taken. You must have heard about the Ganga Action Plan. This multi-crore project came about in 1985 because the quality of the water in the Ganga was very poor. Coliform is a group of bacteria, found in human intestines, whose presence in water indicates contamination by disease-causing microorganisms.

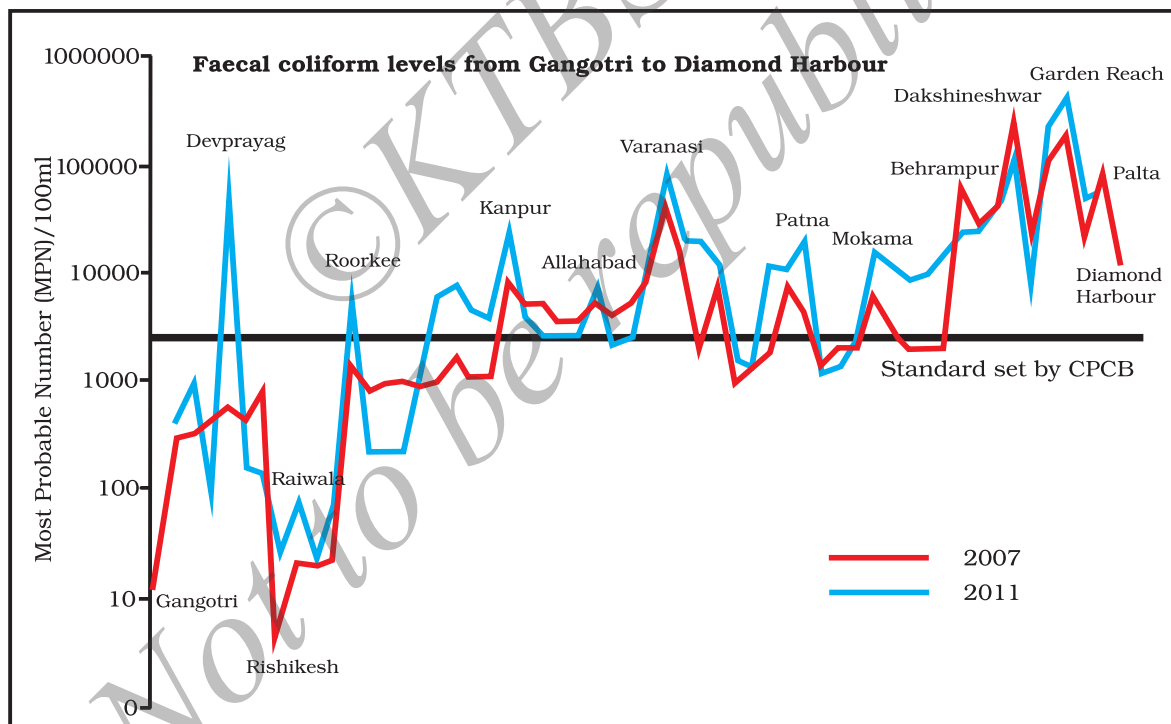

Figure 16.1 Total coliform count levels in the Ganga

Source: Central Pollution Control Board, 2012

Pollution of the Ganga

The Ganga runs its course of over 2500 km from Gangotri in the Himalayas to Ganga Sagar in the Bay of Bengal. It is being turned into a drain by more than a hundred towns and cities in Uttar Pradesh, Bihar and West Bengal that pour their garbage and excreta into it. Largely untreated sewage is dumped into the Ganges every day. In addition, think of the pollution caused by other human activities like bathing, washing of clothes and immersion of ashes or unburnt corpses. And then, industries contribute chemical effluents to the Ganga's pollution load and the toxicity kills fish in large sections of the river. Namami Gange Programme is an Integrated Conservation Mission approved as a Flagship Programme by the Union Government in June, 2014. It was launched to accomplish the twin objectives of effective abatement of pollution conservation and rejuvenation of River Ganga. The National Mission for Clean Ganga is the implementation wing set up in October, 2016.

As you can see, there are some measurable factors which are used to quantify pollution or the quality of the water that we use for various activities. Some of the pollutants are harmful even when present in very small quantities and we require sophisticated equipment to measure them. But as we learnt in Chapter 2, the pH of water is something that can easily be checked using universal indicator.

Activity 16.3

- Check the pH of the water supplied to your house using universal indicator or litmus paper.
- Also check the pH of the water in the local waterbody (pond, river, lake, stream).
- Can you say whether the water is polluted or not on the basis of your observations?

We need not feel powerless or overwhelmed by the scale of the problems because there are many things we can do to make a difference. You must have come across the five R's to save the environment: Refuse, Reduce, Reuse, Repurpose and Recycle. What do they refer to?

Refuse: This means to say No to things people offer you that you don't need. Refuse to buy products that can harm you and the environment, say No to single-use plastic carry bags.

Reduce: This means that you use less. You save electricity by switching off unnecessary lights and fans. You save water by repairing leaky taps. Do not waste food. Can you think of other things that you can reduce the usage of?

Reuse: This is actually even better than recycling because the process of recycling uses some energy. In the 'reuse' strategy, you simply use things again and again. Instead of throwing away used envelopes, you can reverse it and use it again. The plastic bottles in which you buy various food-items like jam or pickle can be used for storing things in the kitchen. What other items can we reuse?

Repurpose: This means when a product can no more be used for the original purpose, think carefully and use it for some other useful purpose. For example, cracked crockery, or cups with broken handles can be used to grow small plants and as feeding vessels for birds.

Recycle: This means that you collect plastic, paper, glass and metal items and recycle these materials to make required things instead of synthesising or extracting fresh plastic, paper, glass or metal. In order to recycle, we first need to segregate our wastes so that the material that can be recycled is not dumped along with other wastes. Does your village/town/city have a mechanism in place for recycling these materials?

Even while making everyday choices, we can make environment-friendly decisions. For doing this, we need to know more about how our choices affect the environment, these effects may be immediate or long-term or long-ranging. The concept of sustainable development encourages forms of growth that meet current basic human needs, while preserving the resources for the needs of future generations. Economic development is linked to environmental conservation. Thus sustainable development implies a change in all aspects of life. It depends upon the willingness of the people to change their perceptions of the socio-economic and environmental conditions around them, and the readiness of each individual to alter their present use of natural resources.

Activity 16.4

- Have you ever visited a town or village after a few years of absence? If so, have you noticed new roads and houses that have come up since you were there last? Where do you think the materials for making these roads and buildings have come from?
- Try and make a list of the materials and their probable sources.
- Discuss the list you have prepared with your classmates. Can you think of ways in which the use of these materials be reduced?

16.1 WHY DO WE NEED TO MANAGE OUR RESOURCES?

Not just roads and buildings, but all the things we use or consume – food, clothes, books, toys, furniture, tools and vehicles – are obtained from resources on this earth. The only thing we get from outside is energy which we receive from the Sun. Even this energy is processed by living organisms and various physical and chemical processes on the earth before we make use of it.

Why do we need to use our resources carefully? Because these are not unlimited and with the human population increasing at a tremendous rate due to improvement in health-care, the demand for all resources is increasing at an exponential rate. The management of natural resources requires a long-term perspective so that these will last for the generations to come and will not merely be exploited to the

hilt for short-term gains. This management should also ensure equitable distribution of resources so that all, and not just a handful of rich and powerful people, benefit from the development of these resources.

Another factor to be considered while we exploit these natural resources is the damage we cause to the environment while these resources are either extracted or used. For example, mining causes pollution because of the large amount of slag which is discarded for every tonne of metal extracted. Hence, sustainable natural resource management demands that we plan for the safe disposal of these wastes too.

The present day global concerns for sustainable development and conservation of natural resources are of recent origin as compared to the long tradition and culture of nature conservation in our country. Principles of conservation and sustainable management were well established in the pre-historic India.

Our ancient literature is full of such examples where values and sensitivity of humans towards nature was glorified and the principle of sustainability was established at its best.

Activity 16.5

- Observe various traditional practices for conservation of nature in your day-to-day life. Share within the peer group. Make a report and submit.

Indian texts such as Upanishads and Smritis contain many descriptions on the uses and management of forests, and highlight sustainability as an implicit theme. One hymn from *Atharva Veda* || 12.1.11 ||, later translated into English in the book *Atharva Veda — the Sanskrit Text with English Translation*, written by Devi Chand in 1997, reads:

Gayaste parvatā himavantoranyam te pṛthivi syonamastu
babhrum kṛṣṇām rohiṇim viśvarūpām dhruvām bhūmi pṛthivīmindraguptām
ajitohato akṣatodhyaṣṭhām pṛthivīmaham ||12.1.11|| (*Atharva Veda*)

“O Earth! Pleasant be thy hills, snow-clad mountains and forests; O numerous coloured, firm and protected earth! On this earth I stand, undefeated, unslain, unhurt.”

Another hymn that reveals utilisation and regeneration principles from *Atharva Veda* || 12.1.35 || reads:

yatte bhūme vikhanāmi kṣipram tadapi rohatu
mā te marma vimṛgvari mā te hridayamarpipam ||12.1.35|| (*Atharva Veda*)

“Whatever I dig out of you, O Earth! May that have quick regeneration again; may we not damage thy vital habitat and heart.”

During the Vedic period, both productive as well as protective aspect of forest vegetation were emphasised. Agriculture emerged as a dominant economic activity during the later Vedic period. This was the time when

the concept of cultural landscape such as sacred forests and groves, sacred corridors and a variety of ethno-forestry practices were evolved that continued to the post-Vedic period, besides a wide range of ethno-forestry practices were infused with the traditions, customs and rituals and followed as a means for protection of nature and natural resource.

Q U E S T I O N S

1. What changes can you make in your habits to become more environment-friendly?
2. What would be the advantages of exploiting resources with short-term aims?
3. How would these advantages differ from the advantages of using a long-term perspective in managing our resources?
4. Why do you think that there should be equitable distribution of resources? What forces would be working against an equitable distribution of our resources?

16.2 FORESTS AND WILDLIFE

Forests are 'biodiversity hotspots'. One measure of the biodiversity of an area is the number of species found there. However, the range of different life forms (bacteria, fungi, ferns, flowering plants, nematodes, insects, birds, reptiles and so on) found, is also important. One of the main aims of conservation is to try and preserve the biodiversity we have inherited. Experiments and field studies suggest that loss of diversity may lead to loss of ecological stability.

16.2.1 Stakeholders

Activity 16.6

- Make a list of forest produce that you use.
- What do you think a person living near a forest would use?
- What do you think a person living in a forest would use?
- Discuss with your classmates how these needs differ or do not differ and the reasons for the same.

We all use various forest produce. But our dependency on forest resources varies. Some of us have access to alternatives, some do not. When we consider the conservation of forests, we need to look at the stakeholders who are –

- (i) the people who live in or around forests are dependent on forest produce for various aspects of their life (see Fig. 16.2).
- (ii) the Forest Department of the Government which owns the land and controls the resources from forests.
- (iii) the industrialists – from those who use 'tendu' leaves to make *bidis* to the ones with paper mills – who use various forest produce, but are not dependent on the forests in any one area.
- (iv) the wildlife and nature enthusiasts who want to conserve nature in its pristine form.

Let us take a look at what each of these groups needs/gets out of the forests. The local people need large quantities of firewood, small timber and thatch. Bamboo is used to make slats for huts, and baskets for collecting and storing food materials. Implements for agriculture, fishing and hunting are largely made of wood, also forests are sites for fishing and hunting. In addition to the people gathering fruits, nuts and medicines from the forests, their cattle also graze in forest areas or feed on the fodder which is collected from forests.

Do you think such use of forest resources would lead to the exhaustion of these resources? Do not forget that before the British came and took over most of our forest areas, people had been living in these forests for centuries. They had developed practices to ensure that the resources were used in a sustainable manner. After the British took control of the forests (which they exploited ruthlessly for their own purposes), these people were forced to depend on much smaller areas and forest resources started becoming over-exploited to some extent. The Forest Department in independent India took over from the British but local knowledge and local needs continued to be ignored in the management practices. Thus vast tracts of forests have been converted to monocultures of pine, teak or eucalyptus. In order to plant these trees, huge areas are first cleared of all vegetation. This destroys a large amount of biodiversity in the area. Not only this, the varied needs of the local people – leaves for fodder, herbs for medicines, fruits and nuts for food – can no longer be met from such forests. Such plantations are useful for the industries to access specific products and are an important source of revenue for the Forest Department.

Do you know how many industries are based on forest produce? A short count reveals timber, paper, lac and sports equipment.

Industries would consider the forest as merely a source of raw material for its factories. And huge interest-groups lobby the government for access to these raw materials at artificially low rates. Since these industries have a greater reach than the local people, they are not interested in the sustainability of the forest in one particular area. For example, after cutting down all the teak trees in one area, they will get their teak from a forest farther away. They do not have any stake in ensuring that one particular area should yield an optimal amount of some produce for all generations to come. What do you think will stop the local people in behaving in a similar manner?



Figure 16.2
A view of a forest life

Activity 16.7

- Find out about any two forest produce that are the basis for an industry.
- Discuss whether this industry is sustainable in the long run. Or do we need to control our consumption of these products?

Lastly, we come to the nature and wildlife enthusiasts who are in no way dependent on the forests, but who may have considerable say in their management. The conservationists were initially taken up with large animals like lions, tigers, elephants and rhinoceros. They now recognise the need to preserve biodiversity as a whole. But shouldn't we recognise people as forming part of the forest system? There have been enough instances of local people working traditionally for conservation of forests. For example, the case of Bishnois community living in western Rajasthan on the border of the Thar desert. Conservation of forest and wildlife has been a religious tenet for them. These nature-loving people have for centuries, been conserving the flora and fauna to the extent of sacrificing their lives to protect the environment. They are living with the basic philosophy that all living things have a right to survive and share all resources. The Government of India has recently instituted an 'Amrita Devi Bishnoi National Award for Wildlife Conservation' in the memory of Amrita Devi Bishnoi, who in 1731 sacrificed her life along with 363 others for the protection of 'khejri' trees in Khejrali village near Jodhpur in Rajasthan.

Studies have shown that the prejudice against the traditional use of forest areas has no basis. Here is an example – the great Himalayan National Park contains, within its reserved area, alpine meadows which were grazed by sheep in summer. Nomadic shepherds drove their flock up from the valleys every summer. When this national park was formed, this practice was put to an end. Now it is seen that without the regular grazing by sheep the grass first grows very tall, and then falls over preventing fresh growth.

Management of protected areas by keeping the local people out or by using force cannot possibly be successful in the long run. In any case, the damage caused to forests cannot be attributed to only the local people – one cannot turn a blind eye to the deforestation caused by industrial needs or development projects like building roads or dams. The damage caused in these reserves by tourists or the arrangements made for their convenience is also to be considered.

We need to accept that human intervention has been very much a part of the forest landscape. What has to be managed in the nature and what may be the extent of this intervention? Forest resources ought to be used in a manner that is both environmentally and developmentally sound – in other words, while the environment is preserved, the benefits of the controlled exploitation go to the local people, a process in which decentralised economic growth and ecological conservation go hand in hand. The kind of economic and social development we want will ultimately determine whether the environment will be conserved or further destroyed. The environment must not be regarded as a pristine collection of plants and animals. It is a vast and complex entity that offers a range of natural resources for our use. We need to use these resources with due caution for our economic and social growth, and to meet our material aspirations.



Figure 16.3
Khejri Tree

16.2.2 Management of forest

We need to consider if the goals of all the above stakeholders with regard to the management of the forests are the same. Forest resources are often made available for industrial use at rates far below the market value while these are denied to the local people. The *Chipko Andolan* ('Hug the Trees Movement') was the result of a grassroots level effort to end the alienation of people from their forests. The movement originated from an incident in a remote village called Reni in Garhwal, high-up in the Himalayas during the early 1970s. There was a dispute between the local villagers and a logging contractor who had been allowed to fell trees in a forest close to the village. On a particular day, the contractor's workers appeared in the forest to cut the trees while the men folk were absent. Undeterred, the women of the village reached the forest quickly and clasped the tree trunks thus preventing the workers from felling the trees. Thus thwarted, the contractor had to withdraw.

Inherent in such a competition to control a natural resource is the conservation of a replenishable resource. Specifically the method of use was being called into question. The contractor would have felled the trees, destroying them forever. The communities traditionally lop the branches and pluck the leaves, allowing the resource to replenish over time. The *Chipko* movement quickly spread across communities and media, and forced the government, to whom the forest belongs, to rethink their priorities in the use of forest produce. Experience has taught people that the destruction of forests affected not just the availability of forest products, but also the quality of soil and the sources of water. Participation of the local people can indeed lead to the efficient management of forests.

An Example of People's Participation in the Management of Forests

In 1972, the West Bengal Forest Department recognised its failures in reviving the degraded *Sal* forests in the south-western districts of the state. Traditional methods of surveillance and policing had led to a 'complete alienation of the people from the administration', resulting in frequent clashes between forest officials and villagers. Forest and land related conflicts in the region were also a major factor in fuelling the militant peasant movements led by the Naxalites.

Accordingly, the Department changed its strategy, making a beginning in the Arabari forest range of Midnapore district. Here, at the insistence of a far-seeing forest officer, A.K. Banerjee, villagers were involved in the protection of 1,272 hectares of badly degraded sal forest. In return for help in protection, villagers were given employment in both silviculture and harvesting operations, 25 per cent of the final harvest, and allowed fuelwood and fodder collection on payment of a nominal fee. With the active and willing participation of the local community, the

sal forests of Arabari underwent a remarkable recovery – by 1983, a previously worthless forest was valued Rs 12.5 crores.

Activity 16.8

- Debate the damage caused to forests by the following —
 - (a) Building rest houses for tourists in national parks.
 - (b) Grazing domestic animals in national parks.
 - (c) Tourists throwing plastic bottles/covers and other litter in national parks.

Q U E S T I O N S

1. Why should we conserve forests and wildlife?
2. Suggest some approaches towards the conservation of forests.

16.3 WATER FOR ALL

Activity 16.9

- Villages suffering from chronic water shortage surround a water theme park in Maharashtra. Debate whether this is the optimum use of the available water.

Water is a basic necessity for all terrestrial forms of life. We studied in Class IX about the importance of water as a resource, the water cycle and how human intervention pollutes waterbodies. However, human intervention also changes the availability of water in various regions.

Activity 16.10

- Study the rainfall patterns in India from an atlas.
- Identify the regions where water is abundant and the regions of water scarcity.

After the above activity, would you be very surprised to learn that regions of water scarcity are closely correlated to the regions of acute poverty?

A study of rainfall patterns does not reveal the whole truth behind the water availability in various regions in India. Rains in India are largely due to the monsoons. This means that most of the rain falls in a few months of the year. Despite nature's monsoon bounty, failure to sustain water availability underground has resulted largely from the loss of vegetation cover, diversion for high water demanding crops, and pollution from industrial effluents and urban wastes. Irrigation methods like dams, tanks and canals have been used in various parts of India since ancient times. These were generally local interventions managed by local people and assured that the basic minimum requirements for both agriculture and daily needs were met throughout the year. The use of this stored

water was strictly regulated and the optimum cropping patterns based on the water availability were arrived at on the basis of decades/centuries of experience, the maintenance of these irrigation systems was also a local affair.

The arrival of the British changed these systems as it changed many other things. The conception of large scale projects – large dams and canals traversing large distances were first conceived and implemented by the British and carried on with no less gusto by our newly formed independent government. These mega-projects led to the neglect of the local irrigation methods, and the government also increasingly took over the administration of these systems leading to the loss of control over the local water sources by the local people.

More to Know!

Kulhs in Himachal Pradesh

Parts of Himachal Pradesh had evolved a local system of canal irrigation called *kulhs* over four hundred years ago. The water flowing in the streams was diverted into man-made channels which took this water to numerous villages down the hillside. The management of the water flowing in these *kulhs* was by common agreement among all the villages. Interestingly, during the planting season, water was first used by the village farthest away from the source of the *kulh*, then by villages progressively higher up. These *kulhs* were managed by two or three people who were paid by the villagers. In addition to irrigation, water from these *kulhs* also percolated into the soil and fed springs at various points. After the *kulhs* were taken over by the Irrigation Department, most of them became defunct and there is no amicable sharing of water as before.

16.3.1 Dams

Why do we seek to build dams? Large dams can ensure the storage of adequate water not just for irrigation, but also for generating electricity, as discussed in the previous chapter. Canal systems leading from these dams can transfer large amounts of water over great distances. For example, the Indira Gandhi Canal has brought greenery to considerable areas of Rajasthan. However, mismanagement of the water has largely led to the benefits being cornered by a few people. There is no equitable distribution of water, thus people close to the source grow water intensive crops like sugarcane and rice while people farther downstream do not get any water. The woes of these people who have been promised benefits which never arrived are added to the discontentment among the people who have been displaced by the building of the dam and its canal network.

In the previous chapter, we mentioned the reasons for opposition to the construction of large dams, such as the Tehri Dam on the river Ganga. You must have read about the protests by the *Narmada Bachao Andolan* ('Save the Narmada Movement') about raising the height of the Sardar Sarovar Dam on the river Narmada. Criticisms about large dams address three problems in particular –

- (i) Social problems because they displace large number of peasants and tribals without adequate compensation or rehabilitation,
- (ii) Economic problems because they swallow up huge amounts of public money without the generation of proportionate benefits,

- (iii) Environmental problems because they contribute enormously to deforestation and the loss of biological diversity.

The people who have been displaced by various development projects are largely poor tribals who do not get any benefits from these projects and are alienated from their lands and forests without adequate compensation. The oustees of the Tawa Dam built in the 1970s are still fighting for the benefits they were promised.

A traditional technology is helping India's "waterman" save thousands of parched villages and transform the lives of thousands of villagers in one of India's most arid regions. In "two decades of efforts of Dr. Rajendra Singh, 8,600 *johads* and other structures to collect water have been built in Rajasthan," and "Water had been brought back to a 1,000 villages across the state." In 2015, he won the Stockholm Water Prize. It is the most prestigious award which honours a person who contributes to the conservation and protection of water resources for the well-being of the planet and its inhabitants.

16.3.2 Water Harvesting

Watershed management emphasises scientific soil and water conservation in order to increase the biomass production. The aim is to develop primary resources of land and water, to produce secondary resources of plants and animals for use in a manner which will not cause ecological imbalance. Watershed management not only increases the production and income of the watershed community, but also mitigates droughts and floods and increases the life of the downstream dam and reservoirs. Various organisations have been working on rejuvenating ancient systems of water harvesting as an alternative to the 'mega-projects' like dams. These communities have used hundreds of indigenous water saving methods to capture every trickle of water that had fallen on their land; dug small pits and lakes, put in place simple watershed systems, built small earthen dams, constructed dykes, sand and limestone reservoirs, set up rooftop water-collecting units. This has recharged groundwater levels and even brought rivers back to life.

Water harvesting is an age-old concept in India. *Khadins*, tanks and *nadis* in Rajasthan, *bandharas* and *tals* in Maharashtra, *bundhis* in Madhya Pradesh and Uttar Pradesh, *ahars* and *pynes* in Bihar, *kulhs* in Himachal Pradesh, ponds in the Kandi belt of Jammu region, and *eris* (tanks) in Tamil Nadu, *surangams* in Kerala, and *kattas* in Karnataka are some of the ancient water harvesting, including water conveyance, structures still in use today (see Fig. 16.4 for an example). Water harvesting techniques are highly locale specific and the benefits are also localised. Giving people control over their local water resources ensures that mismanagement and over-exploitation of these resources is reduced/removed.

In largely level terrain, the water harvesting structures are mainly crescent shaped earthen embankments or low, straight concrete-and-rubble "check dams" built across seasonally flooded gullies. Monsoon rains fill ponds behind the structures. Only the largest structures hold water year round; most dry up six months or less after the monsoons. Their main purpose, however, is not to hold surface water but to recharge the ground water beneath. The advantages of water stored in the ground

are many. It does not evaporate, but spreads out to recharge wells and provides moisture for vegetation over a wide area. In addition, it does not provide breeding grounds for mosquitoes like stagnant water collected in ponds or artificial lakes. The groundwater is also relatively protected from contamination by human and animal waste.

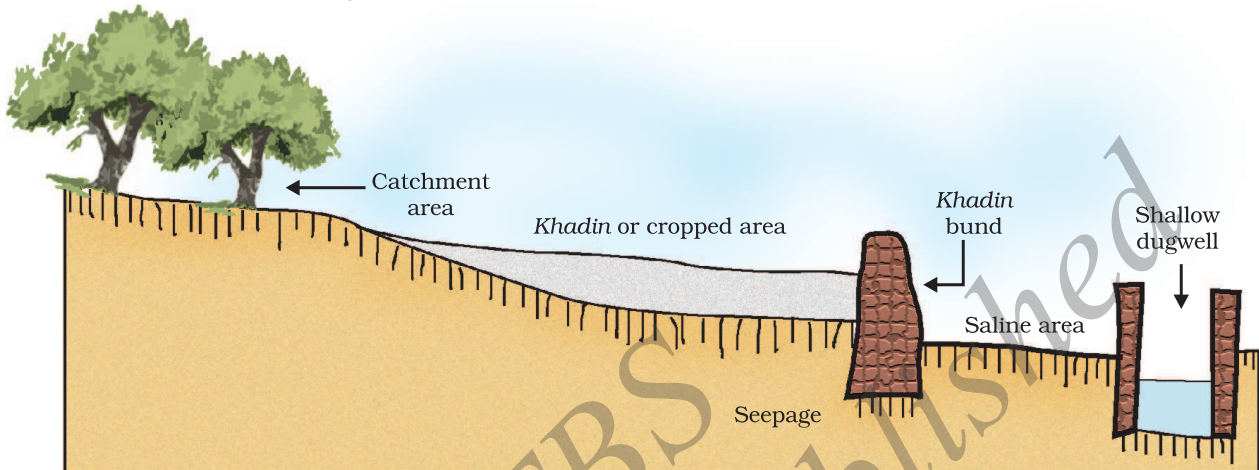

Figure 16.4 Traditional water harvesting system — an ideal setting of the khadin system

Q U E S T I O N S

1. Find out about the traditional systems of water harvesting/management in your region.
2. Compare the above system with the probable systems in hilly/mountainous areas or plains or plateau regions.
3. Find out the source of water in your region/locality. Is water from this source available to all people living in that area?

16.4 COAL AND PETROLEUM

We have seen some of the issues involved in the conservation and sustainable use of resources like forests, wildlife and water. These can meet our needs perpetually if we were to use them in a sustainable manner. Now we come to yet another important resource – fossil fuels, that is, coal and petroleum, which are important sources of energy for us. Since the industrial revolution, we have been using increasing amounts of energy to meet our basic needs and for the manufacture of a large number of goods upon which our lives depend. These energy needs have been largely met by the reserves of coal and petroleum.

The management of these energy sources involves slightly different perspectives from those resources discussed earlier. Coal and petroleum were formed from the degradation of bio-mass millions of years ago and hence these are resources that will be exhausted in the future no matter how carefully we use them. And then we would need to look for alternative sources of energy. Various estimates exist as to how long these resources

Sustainable Management of Natural Resources

will last if the present rate of usage continues. It is estimated that our known petroleum resources will last us for about forty years and the coal resources will last for another two hundred years.

But looking at other sources of energy is not the only consideration when we look at the consumption of coal and petroleum. Since coal and petroleum have been formed from bio-mass, in addition to carbon, these contain hydrogen, nitrogen and sulphur. When these are burnt, the products are carbon dioxide, water, oxides of nitrogen and oxides of sulphur. When combustion takes place in insufficient air (oxygen), then carbon monoxide is formed instead of carbon dioxide. Of these products, the oxides of sulphur and nitrogen and carbon monoxide are poisonous at high concentrations and carbon dioxide is a greenhouse gas. Another way of looking at coal and petroleum is that they are huge reservoirs of carbon and if all of this carbon is converted to carbon dioxide, then the amount of carbon dioxide in the atmosphere is going to increase, leading to intense global warming. Thus, we need to use these resources judiciously.

Activity 16.11

- Coal is used in thermal power stations and petroleum products like petrol and diesel are used in means of transport like motor vehicles, ships and aeroplanes. We cannot really imagine life without a number of electrical appliances and constant use of transportation. So can you think of ways in which our consumption of coal and petroleum products be reduced?

Some simple choices can make a difference in our energy consumption patterns. Think over the relative advantages, disadvantages and environment-friendliness of the following –

- (i) Taking a bus, using your personal vehicle or walking/cycling.
- (ii) Using LED bulbs or fluorescent tubes in your homes.
- (iii) Using the lift or taking the stairs.
- (iv) Wearing an extra sweater or using a heating device (heater or 'sigri') on cold days.

The management of coal and petroleum also addresses the efficiency of our machines. Fuel is most commonly used in internal combustion engines for transportation and recent research in this field concentrates on ensuring complete combustion in these engines in order to increase efficiency and also reduce air pollution.

Activity 16.12

- You must have heard of the Euro I and Euro II norms for emission from vehicles. Find out how these norms work towards reducing air pollution.

16.5 AN OVERVIEW OF NATURAL RESOURCE MANAGEMENT

Sustainable management of natural resources is a difficult task. In addressing this issue, we need to keep an open mind with regard to the interests of various stakeholders. We need to accept that people will act with their own best interests as the priority. But the realisation that such selfish goals will lead to misery for a large number of people and a total destruction of our environment is slowly growing. Going beyond laws, rules and regulations, we need to tailor our requirements, individually and collectively, so that the benefits of development reach everyone now and for all generations to come.

What you have learnt

- Our resources like forests, wildlife, water, coal and petroleum need to be used in a sustainable manner.
- We can reduce pressure on the environment by sincerely applying the maxim of 'Refuse, Reduce, Reuse, Repurpose and Recycle' in our lives.
- Management of forest resources has to take into account the interests of various stakeholders.
- The harnessing of water resources by building dams has social, economic and environmental implications. Alternatives to large dams exist. These are locale-specific and may be developed so as to give local people control over their local resources.
- The fossil fuels, coal and petroleum, will ultimately be exhausted. Because of this and because their combustion pollutes our environment, we need to use these resources judiciously.

EXERCISES

1. What changes would you suggest in your home in order to be environment-friendly?
2. Can you suggest some changes in your school which would make it environment-friendly?
3. We saw in this chapter that there are four main stakeholders when it comes to forests and wildlife. Which among these should have the authority to decide the management of forest produce? Why do you think so?
4. How can you as an individual contribute or make a difference to the management of (a) forests and wildlife, (b) water resources and (c) coal and petroleum?
5. What can you as an individual do to reduce your consumption of the various natural resources?
6. List five things you have done over the last one week to —
 - (a) conserve our natural resources.
 - (b) increase the pressure on our natural resources.
7. On the basis of the issues raised in this chapter, what changes would you incorporate in your lifestyle in a move towards a sustainable use of our resources?

Answers

Chapter 4

1. (b) 2. (c) 3. (b)

Chapter 5

1. (c) 2. (b)

Chapter 8

1. (b) 2. (c) 3. (d)

Chapter 9

1. (c) 2. (d) 3. (a)

Chapter 10

1. (d) 2. (d) 3. (b)
4. (a) 5. (d) 6. (c)

7. Distance less than 15 cm; virtual; Enlarged.

9. Yes

10. 16.7 cm from the lens on the other side; 3.3 cm, reduced; real, inverted.

11. 30 cm

12. 6.0 cm, behind the mirror; virtual, erect

13. $m = 1$ indicates that image formed by a plane mirror is of the same size as the object. Further, the positive sign of m indicates that the image is virtual and erect.

14. 8.6 cm, behind the mirror; virtual, erect; 2.2 cm, reduced.

15. 54 cm on the object side; 14 cm, magnified; real, inverted.

16. -0.50 m; concave lens

17. $+0.67$ m; converging lens

Chapter 11

1. (b) 2. (d) 3. (c) 4. (c)

5. (i) -0.18 m; (ii) $+0.67$ m

6. Concave lens; -1.25 D

7. Convex lens; $+3.0$ D

Chapter 14

1. (b) 2. (c) 3. (c)